

Volume 5 Issue 3

March 2014

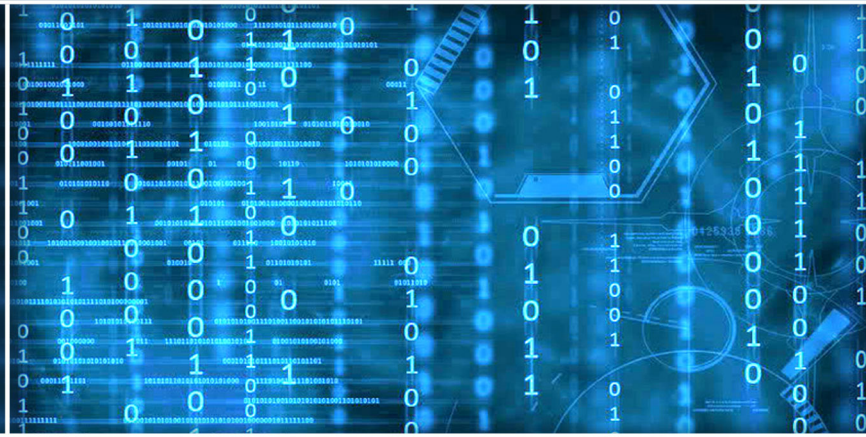

ISSN 2156-5570(Online)  
ISSN 2158-107X(Print)



[www.ijacsa.thesai.org](http://www.ijacsa.thesai.org)



# INTERNATIONAL JOURNAL OF ADVANCED COMPUTER SCIENCE AND APPLICATIONS



THE SCIENCE AND INFORMATION ORGANIZATION  
[www.thesai.org](http://www.thesai.org) | [info@thesai.org](mailto:info@thesai.org)

**OAlster**

**getCITED**

**Google**  
Scholar BETA

**BASE**  
Bielefeld Academic Search Engine

**ULRICHSWEB™**  
GLOBAL SERIALS DIRECTORY

**arXiv.org**

**DOAJ** DIRECTORY OF  
OPEN ACCESS  
JOURNALS

**IET InspecDirect**

**INDEX COPERNICUS**  
INTERNATIONAL

**WorldCat**  
Window to the world's libraries

Microsoft **Academic**  
Search

**EBSCO**  
HOST  
Research  
Databases



# Editorial Preface

## *From the Desk of Managing Editor...*

It is our pleasure to present to you the March 2014 Issue of International Journal of Advanced Computer Science and Applications.

Today, it is incredible to consider that in 1969 men landed on the moon using a computer with a 32-kilobyte memory that was only programmable by the use of punch cards. In 1973, Astronaut Alan Shepherd participated in the first computer "hack" while orbiting the moon in his landing vehicle, as two programmers back on Earth attempted to "hack" into the duplicate computer, to find a way for Shepherd to convince his computer that a catastrophe requiring a mission abort was not happening; the successful hack took 45 minutes to accomplish, and Shepherd went on to hit his golf ball on the moon. Today, the average computer sitting on the desk of a suburban home office has more computing power than the entire U.S. space program that put humans on another world!!

Computer science has affected the human condition in many radical ways. Throughout its history, its developers have striven to make calculation and computation easier, as well as to offer new means by which the other sciences can be advanced. Modern massively-paralleled super-computers help scientists with previously unfeasible problems such as fluid dynamics, complex function convergence, finite element analysis and real-time weather dynamics.

At IJACSA we believe in spreading the subject knowledge with effectiveness in all classes of audience. Nevertheless, the promise of increased engagement requires that we consider how this might be accomplished, delivering up-to-date and authoritative coverage of advanced computer science and applications.

Throughout our archives, new ideas and technologies have been welcomed, carefully critiqued, and discarded or accepted by qualified reviewers and associate editors. Our efforts to improve the quality of the articles published and expand their reach to the interested audience will continue, and these efforts will require critical minds and careful consideration to assess the quality, relevance, and readability of individual articles.

To summarise, the journal has offered its readership thought provoking theoretical, philosophical, and empirical ideas from some of the finest minds worldwide. We thank all our readers for their continued support and goodwill for IJACSA. We will keep you posted on updates about the new programmes launched in collaboration.

Lastly, we would like to express our gratitude to all authors, whose research results have been published in our journal, as well as our referees for their in-depth evaluations.

We hope that materials contained in this volume will satisfy your expectations and entice you to submit your own contributions in upcoming issues of IJACSA

**Thank you for Sharing Wisdom!**

**Managing Editor**  
**IJACSA**  
**Volume 5 Issue 3 March 2014**  
**ISSN 2156-5570 (Online)**  
**ISSN 2158-107X (Print)**  
**©2013 The Science and Information (SAI) Organization**

# Editorial Board

## Editor-in-Chief

### **Dr. Kohei Arai - Saga University**

*Domains of Research: Human-Computer Interaction, Networking, Information Retrievals, Optimization Theory, Modelling and Simulation, Satellite Remote Sensing, Computer Vision, Decision Making Methodology*

---

## Associate Editors

### **Chao-Tung Yang**

**Department of Computer Science, Tunghai University, Taiwan**

*Domain of Research: Cloud Computing*

### **Elena SCUTELNICU**

**"Dunarea de Jos" University of Galati, Romania**

*Domain of Research: e-Learning Tools, Modelling and Simulation of Welding Processes*

### **Krassen Stefanov**

**Professor at Sofia University St. Kliment Ohridski, Bulgaria**

*Domains of Research: Digital Libraries*

### **Maria-Angeles Grado-Caffaro**

**Scientific Consultant, Italy**

*Domain of Research: Sensing and Sensor Networks*

### **Mohd Helmy Abd Wahab**

**Universiti Tun Hussein Onn Malaysia**

*Domain of Research: Data Mining, Database, Web-based Application, Mobile Computing*

### **T. V. Prasad**

**Lingaya's University, India**

*Domain of Research: Bioinformatics, Natural Language Processing, Image Processing, Robotics, Knowledge Representation*

## Reviewer Board Members

- **Abbas Karimi**  
Islamic Azad University Arak Branch
- **Abdel-Hameed Badawy**  
Arkansas Tech University
- **Abdelghni Lakehal**  
Fsdm Sidi Mohammed Ben Abdellah University
- **Abeer Elkorny**  
Faculty of computers and information, Cairo University
- **ADEMOLA ADESINA**  
University of the Western Cape, South Africa
- **Ahmed Boutejdar**
- **Dr. Ahmed Nabih Zaki Rashed**  
Menoufia University
- **Aderemi A. Atayero**  
Covenant University
- **Akbar Hossin**
- **Akram Belghith**  
University Of California, San Diego
- **Albert S**  
Kongu Engineering College
- **Alcinia Zita Sampaio**  
Technical University of Lisbon
- **Ali Ismail Awad**  
Luleå University of Technology
- **Alexandre Bouënard**
- **Amitava Biswas**  
Cisco Systems
- **Anand Nayyar**  
KCL Institute of Management and Technology, Jalandhar
- **Andi Wahju Rahardjo Emanuel**  
Maranatha Christian University, INDONESIA
- **Anirban Sarkar**  
National Institute of Technology, Durgapur, India
- **Anuranjan misra**  
Bhagwant Institute of Technology, Ghaziabad, India
- **Andrews Samraj**  
Mahendra Engineering College
- **Arash Habibi Lashakri**  
University Technology Malaysia (UTM)
- **Aris Skander**  
Constantine University
- **Ashraf Mohammed Iqbal**  
Dalhousie University and Capital Health
- **Ashok Matani**
- **Ashraf Owis**  
Cairo University
- **Asoke Nath**  
St. Xaviers College
- **Ayad Ismaeel**  
Department of Information Systems Engineering- Technical Engineering College-Erbil / Hawler Polytechnic University, Erbil-Kurdistan Region- IRAQ
- **Babatunde Opeoluwa Akinkunmi**  
University of Ibadan
- **Badre Bossoufi**  
University of Liege
- **Basil Hamed**  
Islamic University of Gaza
- **Bharti Waman Gawali**  
Department of Computer Science & information
- **Bhanu Prasad Pinnamaneni**  
Rajalakshmi Engineering College; Matrix Vision GmbH
- **Bilian Song**  
LinkedIn
- **Brahim Raouyane**  
FSAC
- **Brij Gupta**  
University of New Brunswick
- **Bright Keswani**  
Suresh Gyan Vihar University, Jaipur (Rajasthan) INDIA
- **Constantin Filote**  
Stefan cel Mare University of Suceava
- **Constantin Popescu**  
Department of Mathematics and Computer Science, University of Oradea
- **Chandrashekhar Meshram**  
Chhattisgarh Swami Vivekananda Technical University
- **Chao Wang**



- **Chi-Hua Chen**  
National Chiao-Tung University
- **Ciprian Dobre**  
University Politehnica of Bucharest
- **Chien-Pheg Ho**  
Information and Communications Research  
Laboratories, Industrial Technology Research  
Institute of Taiwan
- **Charlie Obimbo**  
University of Guelph
- **Chao-Tung Yang**  
Department of Computer Science, Tunghai  
University
- **Dana PETCU**  
West University of Timisoara
- **Deepak Garg**  
Thapar University
- **Dewi Nasien**  
Universiti Teknologi Malaysia
- **Dheyaa Kadhim**  
University of Baghdad
- **Dong-Han Ham**  
Chonnam National University
- **Dragana Becejski-Vujaklija**  
University of Belgrade, Faculty of organizational  
sciences
- **Driss EL OUADGHIRI**
- **Duck Hee Lee**  
Medical Engineering R&D Center/Asan Institute for  
Life Sciences/Asan Medical Center
- **Dr. Santosh Kumar**  
Graphic Era University, Dehradun, India
- **Elena Camossi**  
Joint Research Centre
- **Eui Lee**
- **Elena SCUTELNICU**  
"Dunarea de Jos" University of Galati
- **Firkhan Ali Hamid Ali**  
UTHM
- **Fokrul Alom Mazarbhuiya**  
King Khalid University
- **Frank Ibikunle**  
Covenant University
- **Fu-Chien Kao**  
Da-Y eh University
- **Faris Al-Salem**
- GCET
- **gamil Abdel Azim**  
Associate prof - Suez Canal University
- **Ganesh Sahoo**  
RMRIMS
- **Gaurav Kumar**  
Manav Bharti University, Solan Himachal Pradesh
- **Ghalem Belalem**  
University of Oran (Es Senia)
- **Giri Babu**  
Indian Space Research Organisation
- **Giacomo Veneri**  
University of Siena
- **Giri Babu**  
Indian Space Research Organisation
- **Gerard Dumancas**  
Oklahoma Medical Research Foundation
- **Georgios Galatas**
- **George Mastorakis**  
Technological Educational Institute of Crete
- **Gunaseelan Devaraj**  
Jazan University, Kingdom of Saudi Arabia
- **Gavril Grebenisan**  
University of Oradea
- **Hadj Tadjine**  
IAV GmbH
- **Hamid Mukhtar**  
National University of Sciences and Technology
- **Hamid Alinejad-Rokny**  
University of Newcastle
- **Harco Leslie Hendric Spits Warnars**  
Budi LUhur University
- **Harish Garg**  
Thapar University Patiala
- **Hamez I. El Shekh Ahmed**  
Pure mathematics
- **Hesham Ibrahim**  
Chemical Engineering Department, Faculty of  
Engineering, Al-Mergheb University
- **Dr. Himanshu Aggarwal**  
Punjabi University, India
- **Huda K. AL-Jobori**  
Ahlia University
- **Iwan Setyawan**  
Satya Wacana Christian University

- **Dr. Jamaiah Haji Yahaya**  
Northern University of Malaysia (UUM), Malaysia
- **James Coleman**  
Edge Hill University
- **Jim Wang**  
The State University of New York at Buffalo,  
Buffalo, NY
- **John Salin**  
George Washington University
- **Jyoti Chaudary**  
High performance computing research lab
- **Jatinderkumar R. Saini**  
S.P.College of Engineering, Gujarat
- **K Ramani**  
K.S.Rangasamy College of Technology,  
Tiruchengode
- **K V.L.N.Acharyulu**  
Bapatla Engineering college
- **Kashif Nisar**  
Universiti Utara Malaysia
- **Kayhan Zrar Ghafoor**  
University Technology Malaysia
- **Kitimaporn Choochote**  
Prince of Songkla University, Phuket Campus
- **Kunal Patel**  
Ingenuity Systems, USA
- **Krasimir Yordzhev**  
South-West University, Faculty of Mathematics and  
Natural Sciences, Blagoevgrad, Bulgaria
- **Krassen Stefanov**  
Professor at Sofia University St. Kliment Ohridski
- **Labib Francis Gergis**  
Misr Academy for Engineering and Technology
- **Lai Khin Wee**  
Biomedical Engineering Department, University  
Malaya
- **Lazar Stosic**  
Collegefor professional studies educators Aleksinac,  
Serbia
- **Lijian Sun**  
Chinese Academy of Surveying and Mapping, China
- **Leandors Maglaras**
- **Leon Abdillah**  
Bina Darma University
- **Ljubomir Jerinic**  
University of Novi Sad, Faculty of Sciences,  
Department of Mathematics and Computer Science
- **Lokesh Sharma**  
Indian Council of Medical Research
- **Long Chen**  
Qualcomm Incorporated
- **M. Reza Mashinchi**
- **M. Tariq Banday**  
University of Kashmir
- **MAMTA BAHETI**  
SNJBS KBJ COLLEGE OF ENGINEERING, CHANDWAD,  
NASHIK, M.S. INDIA
- **Mazin Al-Hakeem**  
Research and Development Directorate - Iraqi  
Ministry of Higher Education and Research
- **Md Rana**  
University of Sydney
- **Miriampally Venkata Raghavendera**  
Adama Science & Technology University, Ethiopia
- **Mirjana Popvic**  
School of Electrical Engineering, Belgrade University
- **Manas deep**  
Masters in Cyber Law & Information Security
- **Manpreet Singh Manna**  
SLIET University, Govt. of India
- **Manuj Darbari**  
BBD University
- **Md. Zia Ur Rahman**  
Narasaraopeta Engg. College, Narasaraopeta
- **Messaouda AZZOUZI**  
Ziane AChour University of Djelfa
- **Dr. Michael Watts**  
University of Adelaide
- **Milena Bogdanovic**  
University of Nis, Teacher Training Faculty in Vranje
- **Miroslav Baca**  
University of Zagreb, Faculty of organization and  
informatics / Center for biomet
- **Mohamed Ali Mahjoub**  
Preparatory Institute of Engineer of Monastir
- **Mohamed El-Sayed**  
Faculty of Science, Fayoum University, Egypt
- **Mohammad Yamin**
- **Mohammad Ali Badamchizadeh**  
University of Tabriz
- **Mohamed Najeh Lakhoua**  
ESTI, University of Carthage

- **Mohammad Alomari**  
Applied Science University
- **Mohammad Kaiser**  
Institute of Information Technology
- **Mohammed Al-Shabi**  
Assistant Prof.
- **Mohammed Sadgal**
- **Mourad Amad**  
Laboratory LAMOS, Bejaia University
- **Mohammed Ali Hussain**  
Sri Sai Madhavi Institute of Science & Technology
- **Mohd Helmy Abd Wahab**  
Universiti Tun Hussein Onn Malaysia
- **Mueen Uddin**  
Universiti Teknologi Malaysia UTM
- **Mona Elshinawy**  
Howard University
- **Maria-Angeles Grado-Caffaro**  
Scientific Consultant
- **Mehdi Bahrami**  
University of California, Merced
- **Miriampally Venkata Raghavendra**  
Adama Science & Technology University, Ethiopia
- **Murthy Dasika**  
SreeNidhi Institute of Science and Technology
- **Mostafa Ezziyani**  
FSTT
- **Marcellin Julius Nkenlifack**  
University of Dschang
- **Natarajan Subramanyam**  
PES Institute of Technology
- **Noura Aknin**  
University Abdelamlek Essaadi
- **Nidhi Arora**  
M.C.A. Institute, Ganpat University
- **Nazeeruddin Mohammad**  
Prince Mohammad Bin Fahd University
- **Najib Kofahi**  
Yarmouk University
- **NEERAJ SHUKLA**  
ITM UNiversity, Gurgaon, (Haryana) Inida
- **N.Ch. Iyengar**  
VIT University
- **Om Sangwan**
- **Oliviu Matel**  
Technical University of Cluj-Napoca
- **Osama Omer**  
Aswan University
- **Ousmane Thiare**  
Associate Professor University Gaston Berger of  
Saint-Louis SENEGAL
- **Omaima Al-Allaf**  
Assistant Professor
- **Paresh V Virparia**  
Sardar Patel University
- **Dr. Poonam Garg**  
Institute of Management Technology, Ghaziabad
- **Professor Ajantha Herath**
- **Prabhat K Mahanti**  
UNIVERSITY OF NEW BRUNSWICK
- **Qufeng Qiao**  
University of Virginia
- **Rachid Saadane**  
EE departement EHTP
- **raed Kanaan**  
Amman Arab University
- **Raja boddu**  
LENORA COLLEGE OF ENGINEERNG
- **Ravisankar Hari**  
SENIOR SCIENTIST, CTRI, RAJAHMUNDRY
- **Raghuraj Singh**
- **Rajesh Kumar**  
National University of Singapore
- **Rakesh Balabantaray**  
IIIT Bhubaneswar
- **RashadAl-Jawfi**  
Ibb university
- **Rashid Sheikh**  
Shri Venkateshwar Institute of Technology , Indore
- **Ravi Prakash**  
University of Mumbai
- **Rawya Rizk**  
Port Said University
- **Reshmy Krishnan**  
Muscat College affiliated to stirling University.U
- **Ricardo Vardasca**  
Faculty of Engineering of University of Porto
- **Ritaban Dutta**  
ISSL, CSIRO, Tasmaniia, Australia
- **Rowayda Sadek**
- **Ruchika Malhotra**  
Delhi Technoogical University
- **Saadi Slami**  
University of Djelfa



- **Sachin Kumar Agrawal**  
University of Limerick
- **Dr.Sagarmay Deb**  
University Lecturer, Central Queensland University,  
Australia
- **Said Ghoniemy**  
Taif University
- **Sasan Adibi**  
Research In Motion (RIM)
- **Sérgio Ferreira**  
School of Education and Psychology, Portuguese  
Catholic University
- **Sebastian Marius Rosu**  
Special Telecommunications Service
- **Selem charfi**  
University of Valenciennes and Hainaut Cambresis,  
France.
- **Seema Shah**  
Vidyalankar Institute of Technology Mumbai,
- **Sengottuvelan P**  
Anna University, Chennai
- **Senol Piskin**  
Istanbul Technical University, Informatics Institute
- **Seyed Hamidreza Mohades Kasaei**  
University of Isfahan
- **Shafiqul Abidin**  
G G S I P University
- **Shahanawaj Ahamad**  
The University of Al-Kharj
- **Shawkl Al-Dubae**  
Assistant Professor
- **Shriram Vasudevan**  
Amrita University
- **Sherif Hussain**  
Mansoura University
- **Siddhartha Jonnalagadda**  
Mayo Clinic
- **Sivakumar Poruran**  
SKP ENGINEERING COLLEGE
- **Sim-Hui Tee**  
Multimedia University
- **Simon Ewedafe**  
Baze University
- **SUKUMAR SETHILKUMAR**  
Universiti Sains Malaysia
- **Slim Ben Saoud**
- **Sudarson Jena**  
GITAM University, Hyderabad
- **Sumit Goyal**
- **Sumazly Sulaiman**  
Institute of Space Science (ANGKASA), Universiti  
Kebangsaan Malaysia
- **Sohail Jabb**  
Bahria University
- **Suhas J Manangi**  
Microsoft
- **Suresh Sankaranarayanan**  
Institut Teknologi Brunei
- **Susarla Sastry**  
J.N.T.U., Kakinada
- **Syed Ali**  
SMI University Karachi Pakistan
- **T C. Manjunath**  
HKBK College of Engg
- **T V Narayana Rao**  
Hyderabad Institute of Technology and  
Management
- **T. V. Prasad**  
Lingaya's University
- **Taiwo Ayodele**  
Infonetmedia/University of Portsmouth
- **Tarek Gharib**
- **THABET SLIMANI**  
College of Computer Science and Information  
Technology
- **Totok R. Biyanto**  
Engineering Physics, ITS Surabaya
- **TOUATI YOUCEF**  
Computer sce Lab LIASD - University of Paris 8
- **VINAYAK BAIRAGI**  
Sinhgad Academy of engineering, Pune
- **VISHNU MISHRA**  
SVNIT, Surat
- **Vitus S.W. Lam**  
The University of Hong Kong
- **Vuda SREENIVASARAO**  
School of Computing and Electrical  
Engineering,BAHIR DAR UNIVERSITY, BAHIR  
DAR,ETHIOPA
- **Vaka MOHAN**  
TRR COLLEGE OF ENGINEERING
- **Wei Wei**
- **Xiaojing Xiang**  
AT&T Labs

- **YASSER ATTIA ALBAGORY**  
College of Computers and Information Technology,  
Taif University, Saudi Arabia
- **YI FEI WANG**  
The University of British Columbia
- **Yilun Shang**  
University of Texas at San Antonio
- **YU QI**  
Mesh Capital LLC
- **Zacchaeus Omogbadegun**  
Covenant University
- **ZAIRI ISMAEL RIZMAN**  
UiTM (Terengganu) Dungun Campus
- **ZENZO POLITE NCUBE**  
North West University
- **ZHAO ZHANG**  
Deptment of EE, City University of Hong Kong
- **ZHIXIN CHEN**  
ILX Lightwave Corporation
- **ZLATKO STAPIC**  
University of Zagreb
- **Ziyue Xu**
- **ZURAINI ISMAIL**  
Universiti Teknologi Malaysia

# CONTENTS

**Paper 1: Auditing Hybrid IT Environments**

*Authors: Georgiana Mateescu, Marius Vlădescu*

**PAGE 1 – 10**

**Paper 2: The Throughput Flow Constraint Theorem and its Applications**

*Authors: Michael T. Todinov*

**PAGE 11 – 24**

**Paper 3: New Framework for Improving Big Data Analysis Using Mobile Agent**

*Authors: Youssef M. ESSA, Gamal ATTIYA, Ayman EL-SAYED*

**PAGE 25 – 32**

**Paper 4: Distributed programming using AGAPIA**

*Authors: Ciprian. I. Padurar*

**PAGE 33 – 43**

**Paper 5: Interventional Spasticity Management for Enhancing Patient – Physician Communications**

*Authors: Chiyuri NAGAYAMA*

**PAGE 44 – 50**

**Paper 6: A Web Mining Approach for Personalized E-Learning System**

*Authors: Manasi Chakurkar, Prof. Deepa Adiga*

**PAGE 51 – 56**

**Paper 7: Audio Content Classification Method Research Based on Two-step Strategy**

*Authors: Sumei Liang, Xinhua Fan*

**PAGE 57 – 62**

**Paper 8: Open Vehicle Routing Problem by Ant Colony Optimization**

*Authors: Er. Gurpreet Singh, Dr. Vijay Dhir*

**PAGE 63 – 68**

**Paper 9: Feasibility of automated detection of HONcode conformity for health-related websites**

*Authors: Célia Boyer, Ljiljana Dolamic*

**PAGE 69 – 74**

**Paper 10: A Students Attendance System Using QR Code**

*Authors: Fadi Masalha, Nael Hirzallah*

**PAGE 75 – 79**

**Paper 11: An autonomous intelligent gateway for wireless sensor network based on mobile node**

*Authors: Hajar Mansouri, Fouad Moutaouakil, Hicham Medromi*

**PAGE 80 – 85**

**Paper 12: Sample K-Means Clustering Method for Determining the Stage of Breast Cancer Malignancy Based on Cancer Size on Mammogram Image Basis**

*Authors: Karmilasari, Suryarini Widodo, Matrisyya Hermita, Nur Putri Agustiyani, Yuhilza Hanum, Lussiana ETP*

**PAGE 86 – 90**



Paper 13: Bipolar Factor and Systems Analysis skills of Student Computing Professionals at University of Botswana, Gaborone

*Authors: Ezekiel U. Okike*

**PAGE 91 – 98**

Paper 14: A Machine Learning Tool for Weighted Regressions in Time, Discharge, and Season

*Authors: Alexander Maestre, Eman El-Sheikh, Derek Williamson, Amelia Ward*

**PAGE 99 – 106**

Paper 15: Collaborative Pharmacy Student Learning Outline for Mobile Atmosphere

*Authors: Dr. Mohamed F. AlAjmi, Shakir Khan*

**PAGE 107 – 113**

Paper 16: Arabic Natural Language Processing Laboratory serving Islamic Sciences

*Authors: Moath M. Najeeb, Abdelkarim A. Abdelkader, Musab B. Al-Zghoul*

**PAGE 114 – 117**

Paper 17: Improved Generalization in Recurrent Neural Networks Using the Tangent Plane Algorithm

*Authors: P May, E Zhou, C. W. Lee*

**PAGE 118 – 126**

Paper 18: Development of a Local Entomological Database for Education and Research using Simulation (Virtual) Methods

*Authors: Emad I. Khater, Mona G. Mahmoud, Enas H. Ghallab, Magdi G. Shehata, Yasser M. Abd El-Latif*

**PAGE 127 – 132**

Paper 19: Evaluating the Impact of Critical Factors in Agile Continuous Delivery Process: A System Dynamics Approach

*Authors: Olumide Akerele, Muthu Ramachandran, Mark Dixon*

**PAGE 133 – 143**

Paper 20: Extending Access Management to maintain audit logs in cloud computing

*Authors: Ajay Prasad, Prasun Chakrabarti*

**PAGE 144 – 147**

Paper 21: LPA Beamformer for Tracking Nonstationary Accelerated Near-Field Sources

*Authors: Amira S. Ashour*

**PAGE 148 – 154**

Paper 22: Survey of Error Correction Mechanisms for Video Streaming over the Internet

*Authors: Jafar Ababneh, Omar Almomani*

**PAGE 155 – 161**

Paper 23: Variational Formulation of the Template-Based Quasi-Conformal Shape-from-Motion from Laparoscopic Images

*Authors: Abed Malti*

**PAGE 162 – 172**

Paper 24: Mobile Web Services: State of the Art and Challenges

*Authors: Khalid Elgazzar, Patrick Martin*

**PAGE 173 – 188**

**Paper 25: Inverted Pendulum-type Personal Mobility Considering Human Vibration Sensitivity**

**Authors: Misaki Masuda, Takuma Suzuki, Kazuto Yokoyama, Masaki Takahashi**

**PAGE 189 – 195**

# Auditing Hybrid IT Environments

Georgiana Mateescu

Computer Science and Automatic Control Faculty  
Polytechnic University of Bucharest  
Bucharest, Romania

Marius Vlădescu

Computer Science and Automatic Control Faculty  
Polytechnic University of Bucharest  
Bucharest, Romania

**Abstract**—This paper presents a personal approach of auditing the hybrid IT environments consisting in both on premise and on demand services and systems. The analysis is performed from both safety and profitability perspectives and it aims to offer to strategy, technical and business teams a representation of the value added by the cloud programme within the company's portfolio. Starting from the importance of the IT Governance in the actual business environments, we presented in the first section the main principles that drive the technology strategy in order to maximize the value added by IT assets in the business products. Section two summarizes the frameworks leveraged by our approach in order to implement the safety and profitability computation algorithms described in the third section. The paper concludes with benefits of our personal frameworks and presents the future developments.

**Keywords**—audit cloud computing; cloud service safety; cloud governance

## I. INTRODUCTION

Nowadays, the companies must continuously provide efficient innovation strategies, by making the IT environment more agile in order to support radical changes on the business process and information flows due to the economic instability and permanent changes in the market.

Together with the requirements of flexibility, scalability and elasticity, the IT environment mandates a new dimension that should ensure proper management of change and efficient operations on both existing and new IT assets. The technology manifests a trend of migrating from specialized "systems" to dedicated services, becoming more and more platform independent in order to get the maximum value from the information technology. This is how in 2003, a new concept was built – IT Governance that aimed to put together all the concepts, definitions, processes, procedures and methodologies that, by reassembling them into a common framework, are able to implement IT programs to deliver high profitability in the business dimension.

Enterprise governance of IT (EGIT) represents the conceptual and pragmatic definition and implementation of processes, structures and relational mechanisms that enable both business and IT people to execute their responsibilities in support of business/IT alignment and the creation of business value from IT-enabled business investments [1].

The six principles that define the Enterprise Governance of IT are [2]:

1) *Responsibility* – this principle refers to the people and the groups of people within the company that must be

aware of their responsibilities regarding the supply of and demand for IT. Also, this principle supposes that those with responsibility for actions also have the authority to perform those actions.

2) *Strategy* – The organization's business strategy considers the current capabilities of IT, the value delivered by the information technology as related to the programs implemented and tries to address the business needs in the ongoing and future initiatives.

3) *Acquisition* – IT acquisitions are made for valid reasons, on the basis of appropriate and ongoing analysis, with clear and transparent decision making based on practical business cases that demonstrate a proper balance between benefits, opportunities, costs, and risks, in both the short term and the long term.

4) *Performance* – IT is able to support the organization, by providing the services, levels of service and service quality that meet current and future business requirements.

5) *Conformance* – IT complies with all mandatory legislations and regulations. Policies and practices are clearly defined, implemented and enforced.

6) *Human Behavior* – IT policies, practices and decisions demonstrate respect for Human Behavior, including the current and evolving needs of all the 'people in the process'.

In order to assess correctly the IT Governance, a proper audit process must be conducted that, starting from mature evaluation frameworks, analyses the specific company and offers a value of the IT Governance level.

In this paper we propose an efficient methodology to audit the hybrid IT environments that consist in both on premise and on demand systems, in order to evaluate the level of the cloud service safety and its profitability. Starting from two existing frameworks presented in Section II, we describe our personal approach in the third section of the paper. The paper concludes with the benefits of our approach and future works.

## II. AUDITING IT GOVERNANCE FRAMEWORKS

There are a lot of frameworks that evaluate the governance and the efficiency of IT environments from different perspectives, one of them is defined in [14]. In our approach, we want to offer a methodology of assessing the safety of the cloud service and its profitability. In order to do that, we start from the Cloud Security Alliance security model and, for each of the domains defined in [3] we specified security controls. The security controls compose the audit questionnaire. The audit process evaluates the control mechanisms using an

algorithm based on the maturity level provided by COBIT. In this section, we made a summary of the main characteristics of the frameworks and standards leveraged by our approach.

A. CSA – Security Model

According to [3] the level of security measures within an organization is characterized by the maturity, effectiveness, and completeness of the risk-adjusted security controls implemented. These controls are implemented in one or more layers ranging from the facilities (physical security), to the network infrastructure (network security), to the IT systems (system security), all the way to the information and applications (application security).

Cloud Security Alliance categorizes security domains as presented in Table 1.

TABLE I. : CLOUD COMPUTING SECURITY DOMAINS

Domain	Description
Governance and Enterprise Risk Management	The ability to govern and measure risk introduced by cloud computing
Legal Issues: Contracts and Electronic Discovery	Security breach disclosure law
Compliance and Audit	Evaluate how cloud affects compliance
Information Management and Data Security	Managing data stored in cloud
Portability and Interoperability	The ability to move data from a cloud provider to another
Traditional Security, Business Continuity and Disaster Recovery	How cloud affects the current security procedures
Data Center Operations	How to evaluate provider’s data center architecture and operations
Incident Response, Notification and Remediation	Proper incident detection, response, notification and remediation
Application Security	Securing application that runs on different cloud deployment model
Encryption and Key Management	Identify proper key usage and key management
Identity and Access Management	Cloud-based IdEA (Identity, Entitlement and Access Management)
Virtualization	Risk associated with VM isolation, VM co-residence
Security as a Service	Third party security assurance including incident management and compliance attestation

Starting from this security domains classification for the cloud models [19], we defined for each of the areas mentioned in the table above, the required controls that lower the risk associated with the domain. This research activity was performed based on existing cloud practice and traditional security measures and concluded in the definition of most relevant mechanisms and procedures that must be evaluated during an audit process.

In order to assess the level of conformity and the risk associated with the lack of mature implementation of the mechanisms, we used the capability model defined by COBIT.

B. COBIT

COBIT (Control Objectives for Information and Related Technology) [4] represents the framework implemented by ISACA in order to define the environment of a company that

defines governance and management of enterprise IT from both business and management perspective.

This framework is based on five principles:

1) Meeting Stakeholder Needs – this principle describes the COBIT objectives from IT requirements perspective that must fulfill the business needs.

2) Covering the Enterprise End-to-End – this principle describes the approach used in this framework to address all the aspects related to IT components management and governance by relating them with the existing business processes and information flows.

3) Applying Single Integrated Framework – this principle describes the scope of COBIT to include all the functions and process that exists within a company in a single framework.

4) Enabling a Holistic Approach – this principle presents the IT Governance and Management in a systematic way by controlling them with a generic model proposed by ISACA. This model is driven by IT enablers that address all the existing resources and facts that lead to IT governance.

5) Separating Governance from Management – this principle describes the differences between the two processes and the mechanism that interconnects them.

Based on these principles, ISACA build a capability model able to evaluate the level of IT governance and management. This model consists of 6 different capability levels each control can implement. The next picture depicts the COBIT 5 Capability model leveraged by our approach:

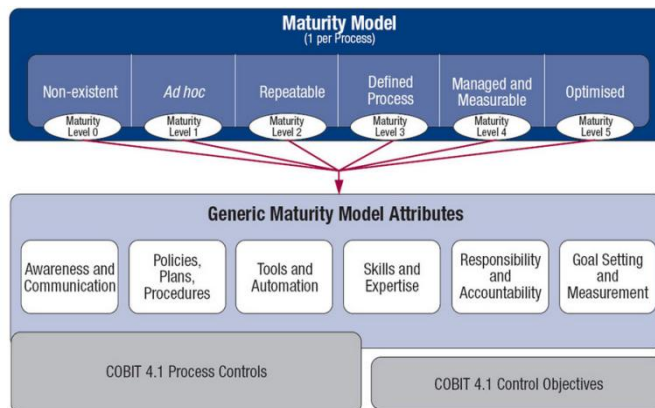

Fig. 1. COBIT Capability Model [4]

This capability level implements the restriction that each level can be achieved only after the previous one was successfully fulfilled. Also, there is a huge difference between the process that is in level 1 and the ones in superior levels because, once the process reached level 1, it means that all the performance attributes were achieved.

C. Val IT

ISACA describes in [5] an evaluation model for the value added to the enterprise by the IT programs. This framework is based on the following principles:

IT-enabled investments will:

- 1) Be managed by an investment portfolio
  - 2) Include all the activities required in order to obtain the business benefits from the IT program
  - 3) Be managed through their entire economical lifecycle
- Value delivery practices will:
- 4) Recognize there are different categories of investments that will be evaluated and managed differently
  - 5) Define and monitor key metrics and respond quickly to any changes or deviations
  - 6) Engage all stakeholders and assign appropriate accountability for the delivery of capabilities and the realization of business benefits
  - 7) Be continually monitored, evaluated and improved

Val IT uses the following concepts in order to assess the maturity level of an enterprise in implementing IT programs [5]:

**Project**—A structured set of activities concerned with delivering a defined capability to the enterprise based on an agreed-upon schedule and budget

**Programme**—A structured group of inter-dependent projects that are both necessary and sufficient to achieve a desired business outcome and create value.. The investment programme is the primary unit of investment within Val IT.

**Portfolio**—Groupings of ‘objects of interest’ (investment programmes, IT services, IT projects, other IT assets or resources) managed and monitored to optimize business value. The investment portfolio is of primary interest to Val IT. IT service, project, asset or other resource portfolios are of primary interest to COBIT.

The maturity evaluation is implemented within Val IT using specific process metrics that analyze the information flows and business process from the following perspectives:

*Value Governance* - the goal of this domain is to ensure that value management practices are embedded in the enterprise, enabling it to secure optimal value from its IT-enabled investments throughout their full economic life cycle.

*Portfolio Management* – the goal of this domain is to ensure that an enterprise secures optimal value across its portfolio of IT-enabled investments.

*Investment Management* – the goal of this domain is to ensure that the enterprise's individual IT-enabled investments contribute to optimal value.

The picture below depicts the Val IT processes and domains:

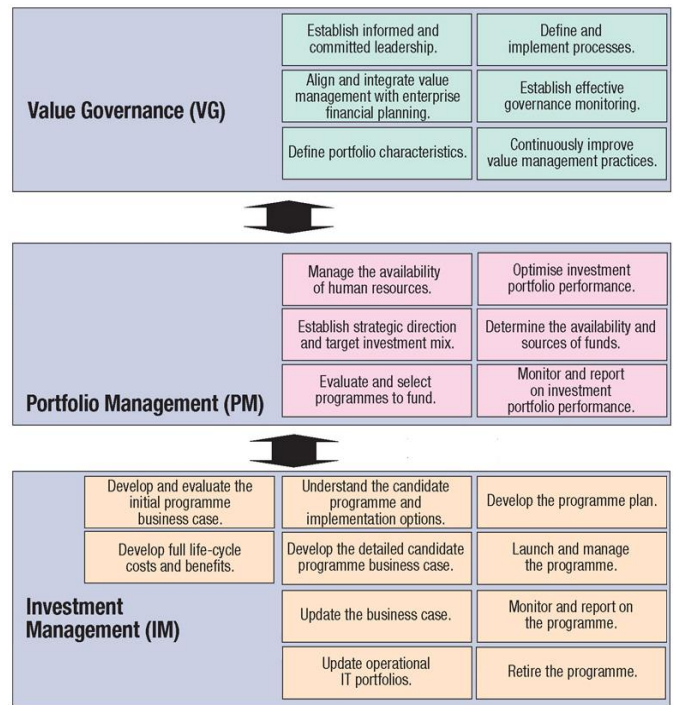

Fig. 2. Val IT Processes and Domains

In our approach we use this model in order to determine the level of the enterprise maturity related to the implementation of cloud programmes. Beside COBIT and Val IT, ISACA also issued a number of papers that describe general guidelines [6] regarding the evaluation of business continuity and the IT governance within cloud computing architecture [7][8].

Starting from these specialized opinions, we created an audit framework that quantifies the safety level of a cloud service based on the security measures implemented within the architecture analyzed. During our assess, we have a second indicator – the profitability level of the programme that invested in the cloud service, which is computed based on the maturity level of the company’s practices used during the programme and on the risk manifested by the cloud service, evaluated in the safety section of the audit.

### III. PERSONAL APPROACH

#### A. General Approach

Our audit methodology is based on questionnaires consisting in security measures defined for hybrid TI environments that ensure a high level of safety, governance and operability within the infrastructure.

These controls are classified in domains according to the guidelines from [3] presented in the second section of this paper. They address the major aspects of each domain by analyzing both on premise and on demand specific controls and procedures.

The audit process can address one or multiple domains within one assessment [20]. Each control is evaluated using the capability model of COBIT presented in section 2 which represents the reference model in assessing the level of implementation of each security mechanism included in the audit questionnaire. The security measures [18] and procedures address both service provider and consumer assets. The safety level is computed against an assumed level of risk for each cloud service and an application sensibility:

- The assumed level of risk has direct impact in computing the safety level by addressing the difference between the actual level of security control implementation and the maximum one
- The application sensibility reflects in the correction factor inserted in the computation of risk, by the previously mentioned difference.

After computing the safety level, we offer an approach that quantifies also the level of conformity with the CSA [3] best practices and recommendation. This indicator is computed against the assumed risk level that is materialized in the minimum safety level that must be met by the domain in order to be classified as compliant. Once the domain is compliant, the conformity level is computed based on the safety level.

For the computation of profitability level, beside the analysis of the security measures realized using the approach we defined above, we use Val IT process measures to assess the level of company's maturity in implementing, governing and operating the hybrid IT programmes.

The evaluation that leverages the Val IT framework uses the 3 domains described in the previous section and evaluates the maturity of the metrics included in the audit questionnaire by comparing estimated maturity level with the one obtained after the assessment.

The profitability assessment can be conducted for a single programme or for the entire portfolio. In case the audit addresses the entire portfolio, the profitability factor algorithm takes into consideration the risk level of the audited programme within the portfolio, and for the other ones, it computes the profitability level by evaluating only the maturity level.

At the end of this methodology, we present a mechanism to compute the internal rate of return of the audit target – the portfolio or the programme addressed during the audit process.

In the next two sections we present our personal methodology of evaluating the safety and profitability level for an assessed cloud service contracted within a hybrid IT environment.

### B. Computation of Safety Level

The safety level represents the level of security controls implementation as compared to the assumed risk defined for the application that is being evaluated.

In order to compute the safety level, the audit process must address the entire audit questionnaire for the domain being evaluated. Based on the responses, we define the application risk as the uncertainty rate reported to the cloud vulnerabilities from the analyzed security domain, materialized in the implementation level of each control:

$$AR_i = c_{NSA} + \sum_{k=1}^n (5 - s_k) \cdot c_A \quad (1)$$

Where:

- $AR_i$  is the application risk for the evaluated domain  $i$
- $c_{NSA}$  is the correction risk constant computed based on the existing cloud community experience. Its value is 0.01 and it is introduced for practical reasons because there is no domain with zero risk.
- $s_k$  is the implementation level for control  $k$  from the domain  $i$
- $c_A$  is the correction constant applied to the risk defined for the control. This constant depends on the industry the target belongs to, and on the sensitivity rate of the cloud service.
- $n$  is the number of controls being evaluated in the audit process

Each cloud service analyzed has associated with it the assumed level of risk ranked from 1 to 3 – 1 meaning that the service should be very secured and 3 meaning that, providing the type of data and the business process and information flows being implemented in the cloud, the balance between security and costs should go on the cost savings side. The risk level is defined by the strategy team during the documentation of the business case that leads to the programme implementation. The assumed level of risk is evaluated using the following expression:

$$AR'_i = RL \cdot n \cdot c_A \quad (2)$$

Where:

- $AR'_i$  is the assumed risk for the evaluated domain  $i$
- $RL$  is the risk level defined in the programme business case
- $c_A$  is the correction constant applied to the risk defined for the control. This constant depends on the industry the target belongs to, and on the sensitivity level of the cloud service.
- $n$  is the number of controls being evaluated in the audit process

Using the two measures presented above, the safety level is computed using the following expression:

$$SL_i = \frac{5n(1 - c_A) - AR_i / AR'_i}{5n} \cdot 100 \quad (3)$$

Where:

$SL_i$  is the safety level for the evaluated domain  $i$

$c_A$  is the correction constant applied to the risk defined for the control. This constant depends on the industry the target belongs to, and on the sensitivity level of the cloud service.

$AR'_i$  is the assumed risk for the evaluated domain  $i$

$AR_i$  is the application risk for the evaluated domain  $i$

$n$  is the number controls being evaluated in the audit process

For the scenarios when the audit process evaluates multiple domains, the safety level is the arithmetic mean of the safety levels of the individual domains:

$$SL = \frac{\sum_{i=1}^n SL_i}{n} \quad (4)$$

Where:

- $SL$  is the safety level of the audit process
- $SL_i$  is the safety level for the evaluated domain  $i$
- $n$  is the number of domains in scope for the audit process.

Based on the safety level and on the assumed risk level, the conformity level is computed using the following expression:

$$CL_i = \frac{1 + (-1)^c}{2} \left( SL_{\min} + \frac{SL_i - SL_{\min}}{SL_{\min}} \right) \quad (5)$$

Where:

- $CL_i$  is the compliance level for the evaluated domain  $i$
- $SL_i$  is the safety level for the evaluated domain  $i$
- $c$  is the compliance factor that ensure that the compliance level is zero if the minimum safety level is not reached. This factor is computed using the following expression:

$$c = \begin{cases} 1, & SL_i < SL_{\min} \\ 2, & SL_i > SL_{\min} \end{cases} \quad (6)$$

- $SL_{\min}$  is the minimum safety level that must be obtained by a domain in order to be compliant and it is computed based on the assumed level of risk:

$$SL_{\min} = 1 - RL \cdot c_c \quad (7)$$

Where:

- $SL_{\min}$  is the minimum safety level
- $RL$  is the assumed risk level for the application
- $c_c$  is the conformity constant and its value depends on the assumed risk level according to the following table:

TABLE II. CONFORMITY CONSTANT VALUES

Risk Level = $RL$	Conformity Constant = $c_c$
1	0.001
2	0.25
3	0.33

The conformity level is the measure of the security and governance measures and controls implementation within the audit architecture evaluated against the best practices recommended by the standards used as references when we defined the audit framework.

Therefore the two levels computed by our approach in the safety section of the audit process, offer a realistic view of the contracted cloud service by analyzing the entire integration context.

Our methodology analyzes cloud provider and consumer controls in order to evaluate the level of performance, governance, risk, management and operation of the IT domain by including in the audit questionnaire assets from both parties.

### C. Computation of Profitability Level

The profitability level represents the rate of capitalization of the financial investments engaged for a programme.

In order to compute the profitability level, our approach starts from the maturity level of programme evaluated using specific process metrics. All the processes and flows metrics are classified into the Val IT specific domains and address the following topics:

- Level of leadership agreement on value governance principles
- Level of leadership engagement
- Degree of implementation and compliance with value management processes
- Level of satisfaction with IT's contribution to business value
- Percentage of IT expenditures that have direct traceability to business strategy
- Percentage increase in portfolio value over time
- New ideas per investment category, and percentage that are developed into detailed business cases
- Completeness and compliance of business cases (initial and updated)
- Percentage of expected value realise

After the audit process assesses all the audit questionnaire items, the maturity score is computed:

$$MS = \frac{\sum_{i=1}^m ms_i}{m} \quad (8)$$

Where:

- $MS$  is the maturity score of the programme being analyzed
- $ms_i$  is the maturity score of the metric  $i$
- $m$  is the total number of metrics that are evaluated during the audit process

Using the maturity score computed using (8) and the expected maturity level defined within the business case of the audited programme, we defined the indicator of achievement:

$$i_a = \frac{MS}{ML} \cdot 100 \quad (9)$$

Where:

- $i_a$  is the indicator of achievement of the analyzed programme
- $MS$  is the maturity score of the programme being analyzed
- $ML$  is the expected maturity level defined for the programme being analyzed

Based on the achievement indicator, we compute the underperformance index:

$$ui = \frac{1 + (-1)^{c_j}}{2} \cdot (1 - i_a) \quad (10)$$

Where:

- $ui$  is the underperformance index of the programme
- $i_a$  is the indicator of achievement of the analyzed programme
- $c_j$  is the completion factor of the programme:

$$c_f = \begin{cases} 2, & i_a < 1 \\ 1, & i_a \geq 1 \end{cases} \quad (11)$$

Where:

- $c_f$  is the completion factor of the programme
- $i_a$  is the indicator of achievement of the analyzed programme

The underperformance index has direct impact on the update rate used to compute the Net Present Value which classifies an investment as being profitable or not.

The update rate is the method that provides a measure to the comparison between the economical parameters and

financial indicators accomplished in different periods of time allowing in this way the classification of the program/investment as profitable.

In order to compute the update rate in the hybrid IT environments audit process we use the following expression:

$$u_r = f(ui, c_i, R) \quad (12)$$

Where:

- $u_r$  is the update rate used in order to compute the profitability of the programme
- $ui$  is the underperformance index of the analyzed programme
- $c_i$  is the cost of the investment in the programme
- $R$  is the risk indicator associated with the cloud service implemented in the analyzed programme

For the audit processes that address the entire portfolio, without assessing the safety evaluation for the all the programmes, the update rate is computed as the arithmetic mean of the updates rates of all the programmes. If the programme was not assessed for safety, the update rate is computed using the expression:

$$u_r = c_i + ui \quad (13)$$

Where:

- $u_r$  is the update rate used in order to compute the profitability of the programme
- $ui$  is the underperformance index of the analyzed programme
- $c_i$  is the cost of the investment in the programme

For the programmes where the safety evaluation was conducted, the update rate is:

$$u_r = ui + c_i + R \quad (14)$$

Where:

- $u_r$  is the update rate used in order to compute the profitability of the programme
- $ui$  is the underperformance index of the analyzed programme
- $c_i$  is the cost of the investment in the programme
- $R$  is the risk indicator associated with the cloud service implemented in the analyzed programme

The risk indicator is the arithmetic mean of the risks associated with all the domains being addressed by the safety assessment:



$$R = \frac{\sum_{i=1}^n 1 - SL_i}{n} \quad (15)$$

Where:

- $R$  is the risk indicator associated with the cloud service implemented in the analyzed program
- $SL_i$  is the safety level for the evaluated domain  $i$
- $n$  is the number of domains in scope for the audit process

The Net Present Value (NPV) represents an investment evaluation method that is dependent on the total amount of costs and incomes for a programme. NPV makes comparisons between cash flow of the program and investment effort involved in doing so. The formula for calculating this is:

$$NPV = I_T - C_T \quad (16)$$

Where:

- $NPV$  is Net Present Value of the programme
- $I_T$  is the total income
- $C_T$  is the total cost

The total income is defined by:

$$I_T = \sum_{k=1}^y \frac{I_E}{(1 + u_r)^k} \quad (17)$$

Where:

- $I_T$  is the total income
- $I_E$  is the estimated income for year  $k$
- $u_r$  is the update rate
- $y$  is number of years the programme lasts

The total costs are computed based on:

- Initial investments
- Operational costs during the programme
- The programme period
- The update rate

$$C_T = TI + \sum_{k=1}^y \frac{C_o}{(1 + u_r)^k} \quad (18)$$

Where:

- $C_T$  is the total cost
- $TI$  is total investment in the programme
- $C_o$  is the operation cost for year  $k$

- $u_r$  is the update rate
- $y$  is number of years the programme lasts

Considering (17) and (18), the NPV is:

$$NPV = \sum_{k=1}^y \frac{I_E}{(1 + u_r)^k} - (TI + \sum_{k=1}^y \frac{C_o}{(1 + u_r)^k}) \quad (19)$$

For the audit processes that address the entire portfolio, the NPV is computed for each programme the portfolio contains. In this way we are able to assess the profitability of each of the portfolio components. In order to evaluate the overall profitability, the update rate for the portfolio NPV is computed using the mean update rate of all programmes included in the portfolio.

Based on NPV, we defined the profitability level as:

$$PL = \begin{cases} 0, & NPV < 0 \\ 1, & NPV \geq 0 \end{cases} \quad (20)$$

Where:

- $PL$  is the profitability level
- $NPV$  is Net Present Value of the programme

In order to determine the profitability level of the portfolio we use the same expression, but the update rate is computed by considering the individual update rates for each programme with the portfolio.

In order to evaluate another specific economic factor, the internal rate of return, we use the following expression:

$$IRR = u_{r_{min}} - (u_{r_{max}} - u_{r_{min}}) \cdot \frac{NPV_+}{NPV_+ - NPV_-} \quad (21)$$

Where:

- $IRR$  is the internal rate of return
- $u_{r_{min}}$  is the minimum update rate – this rate ensures a positive NPV which classifies the investment as profitable
- $u_{r_{max}}$  is the maximum update rate – this rate ensures a negative NPV
- $NPV_+$  is the positive Net Present Value of the programme – this value classifies the investment as profitable
- $NPV_-$  is the negative Net Present Value of the programme

In order to compute the required measures for the internal rate of return, we use the following algorithms:

1. If  $NPV$  computed during the audit process is positive then:

$$NPV_+ = NPV_a$$

Where:

- $NPV_+$  is positive Net Present Value of the programme
- $NPV_a$  is the Net Present Value computed during the audit

$$u_{min} = u_a$$

Where:

- $u_{min}$  is the minimum update rate
- $u_a$  is the update rate obtained during the audit

In order to compute  $u_{max}$  şî  $NPV_+$  the following

iterative algorithm is used:

- $u_r = u_{min}$
- $u_r = u_r + 0.03$
- The NPV is computed using:

$$NPV = \sum_{i=1}^y \frac{I_i}{(1+u_r)^i} - (TI + \sum_{i=1}^y \frac{C_o}{(1+u_r)^i})$$

d. If NPV from step c is negative,

$$NPV_- = NPV$$

Where:

- $NPV_-$  is the negative Net Present Value of the programme
- $NPV$  is Net Present Value computed in step c

Where:

$$u_{max} = u_r$$

- $u_{max}$  is the maximum update rate
- $u_r$  is the update rate obtained at step b
- e. If NPV from step c is positive a new iteration is performed from step b

Fig. 3. Algorithm to compute IRR measures if the audited NPV is positive

The picture above depicts the method used to find the measures required in order to compute the internal rate of return if, after conducting the profitability audit according to the methodology we proposed, the result of NPV is positive.

The picture below depicts the method used to find the measures required in order to compute the internal rate of return if, after conducting the profitability audit according to the methodology we proposed, the result of NPV is negative. Usually, in this scenario, the IRR obtained will be less than the one expected by the investors providing that a negative NPV during the audit highlights a lack of profitability for that programme.

In these scenarios a deep analysis must be performed in order to see if the risks and maturity levels assessed during the audit must be fine-tuned which means the expectations for the programme were not properly set, or if the programme did not reach the maturity expected and its security and governance mechanisms and controls do not prove enough capabilities.

2. If  $NPV$  computed during the audit process is negative then:

$$NPV_- = NPV_a$$

Where:

- $NPV_-$  is the negative Net Present Value of the programme
- $NPV_a$  is the Net Present Value computed during the audit

$$u_{max} = u_a$$

Where:

- $u_{max}$  is the maximum update rate
- $u_a$  is the update rate obtained during the audit

In order to compute  $u_{min}$  şî  $NPV_-$  the following

iterative algorithm is used:

- $u_r = u_{max}$
- $u_r = u_r - 0.03$
- The NPV is computed using:

$$NPV = \sum_{i=1}^y \frac{I_i}{(1+u_r)^i} - (TI + \sum_{i=1}^y \frac{C_o}{(1+u_r)^i})$$

d. If NPV from step c is positive,

$$NPV_+ = NPV$$

Where:

- $NPV_+$  is the positive Net Present Value of the programme
- $NPV$  is Net Present Value computed in step c

$$u_{min} = u_r$$

Where:

- $u_{min}$  is the minimum update rate
- $u_r$  is the update rate obtained at step b
- e. If NPV from step c is negative a new iteration is performed from step b

Fig. 4. Algorithm to compute IRR measures if the audited NPV is negative

In this section we presented an efficient mechanism of economical rates evaluation by considering during the analysis both financial and technical aspects from the IT programme being assessed. In this way we offered a relevant representation of the contracted cloud service for both technical and non-technical representatives from company being evaluated. We managed with our approach to translate the security measures and procedures in business figures able to classify the investment as profitable or not. Also, based on the Val IT maturity level leveraged in our framework, we measured the governance and management capabilities of the company in operating the analyzed IT asset. This offers an important decision support for the strategy team regarding the development direction and new cloud adoption roadmap.

#### IV. CONCLUSIONS

The information security and knowledge profitability are some the most important aspects within an organization that ensure business continuity and minimization of risk [13]. Their maximum benefits can be achieved by leveraging the IT assets capabilities in order to ensure data availability, business process and information flow high performance, sensitive data protection and business agility. All these characteristics can be obtained only if the company implements a proper IT governance and efficient management and operational processes and procedures.

A proper IT Governance strategy ensures the following benefits [9]:

- Cost reduction;
- Performance improvement;
- Ability to react quickly to market changes;
- Increased customer satisfaction;
- More sustainable practices;
- Increased revenue per dollar cost;
- General workplace benefits for the board, management and staff.

By combining technical aspects [10] [12] divided into main security drivers with governance and operations related factors, our approach offers a full evaluation analysis of cloud system that quantifies the overall safety of the cloud safety [11] from both technological and operational perspective. In this way, the audit process can be a key decision support for the IT strategy roadmap.

After the safety evaluation, we implemented a methodology to quantify the profitability of the IT programme that implemented the cloud service, offering in this way an economical representation of the service risk related to the operational, governance and security aspects analyzed during the first step of the audit process.

Our approach offers the following benefits:

- Quantifies the safety score based on security measures and controls that are compliant with cloud standards by comparing the implementation rate of key security controls with the assumed risk for the cloud service. In this way we managed to implement an efficient algorithm that takes into consideration all key contextual factors from the cloud service implementation and adoption process.
- Measures the conformity level for the standards used as reference in defining the audit framework. The main standard leveraged is the CSA Security model [3], but when we defined the specific controls to be evaluated, we included the best practice and state of the art of the security measures implemented in the traditional architecture and adopted also by the cloud community.
- Computes the conformity level based on the assumed risk and it is evaluated on each analyzed domain,

emphasizing in this way the domains that require improvement [17].

- Offers an efficient methodology for complex analysis that shows strengths and weaknesses of the analyzed cloud service [16] in the enterprise architecture [18]
- Offers decision support for future cloud adoption by evaluating the rate of company maturity and adaptability to change by assessing the entire stack of mechanisms, controls, process and procedures defined within the company in order to obtain an efficient governance and management process.
- By using as a reference model an international standard, we ensure that the principals, best practices and mature recommendations are part of the audit process. Also, by leveraging an existing framework for initial assessment of the implementation level, we obtain all the benefits of a framework that proved its value during the experience.
- Offers a business relevant measures of the IT assets, by quantifying the profitability level of the programme based on the cloud service risk
- Offers a financial overview of the IT programme that implements the cloud service which can be used as decision support for future IT innovation strategies
- Assesses the level of the organization adaptability to the new trend of cloud computing
- Assesses the maturity and efficiency of the existing governance and management procedures for the new type of IT environment: the cloud computing architecture
- Assesses the integration between on premise and on demand systems by evaluating key security factors. This is possible due to the holistic representation of the audit process that assesses the control measures on domain basis.

By providing all the advantages mentioned above, our methodology helps the company gain visibility on their own IT environment by evaluating the governance, management and operations maturity levels using a holistic approach together with the security aspects [15].

This approach suffers permanent changes as the cloud practice keeps on gaining more and more maturity and adopters. Considering this, our set of controls must be permanently updated and adapted on the specificity of the system and business processes being analyzed.

In order to optimize our evaluation method, we want to fine tune the security measures being assessed by specializing the audit process based on industries and types of companies. In this way we can evaluate particular controls imposed by specific standards and regulations. Other improvement would consist in leveraging the approach for cloud providers specific environments, in order to offer a measure of the provider itself instead of addressing the cloud service in the consumer context.

REFERENCES

- [1] Wim Van Grembergen and Steven De Haes , Business Strategy and Applications in Enterprise IT Governance, 2012, IGI Global ISBN:9781466617797
- [2] Wim Van Grembergen, Steven De Haes, Enterprise Governance of Information Technology: Achieving Strategic Alignment and Value, 2008 , Springer ISBN:9780387848815
- [3] Cloud Security Alliance, Security Guidance for critical areas of focus in cloud computing v3.0, 2011 <https://cloudsecurityalliance.org/guidance/csaguide.v3.0.pdf>
- [4] ISACA, COBIT 5: A Business Framework for the Governance and Management of Enterprise IT, 2012, ISACA ISBN:9781604202373
- [5] ISACA, Enterprise Value: Governance of IT Investments: The Val IT Framework 2.0, 2008 <http://www.isaca.org/Knowledge-Center/Research/ResearchDeliverables/Pages/Val-IT-Framework-2.0.aspx> , ISACA ISBN:9781604200669
- [6] ISACA, Monitoring Internal Control Systems and IT: A Primer for Business Executives, Managers and Auditors on How to Embrace and Advance Best Practices, 2010, ISACA ISBN:9781604201109
- [7] ISACA, Business Continuity Management Audit/Assurance Program, 2011, ISACA ISBN:9781604201864
- [8] ISACA, IT Control Objectives for Cloud Computing: Controls and Assurance in the Cloud, 2011, ISACA ISBN:9781604201826
- [9] A. L. Holt, Governance of IT: An Executive Guide to ISO/IEC 38500, 2013,BCS,ISBN:9781780171548
- [10] Chris Davis, Mike Schiller, Kevin Wheeler, IT Auditing: Using Controls to Protect Information Assets, Second Edition, 2011 McGraw-Hill/Osborne ISBN:9780071742382
- [11] Ben Halpert, Auditing Cloud Computing: A Security and Privacy Guide, 2011, John Wiley & Sons ISBN:9780470874745
- [12] Brian J.S. Chee, Curtis Franklin, Cloud Computing: Technologies and Strategies of the Ubiquitous Data Center, 2010, Auerbach Publications ISBN:978143980612
- [13] Kurt J. Engemann and Douglas M. Henderson, Business Continuity and Risk Management: Essentials of Organizational Resilience, 2012, Rothstein Associates ISBN:9781931332545
- [14] Robert R. Moeller, COSO Enterprise Risk Management: Establishing Effective Governance, Risk, and Compliance, Second Edition, 2011, John Wiley & Sons ISBN:9780470912881
- [15] Jatinder N. D. Gupta, Sushil K. Sharma, Handbook of Research on Information Security and Assurance, 2009, IGI Global, ISBN:9781599048550
- [16] Charles Babcock, Management Strategies for the Cloud Revolution: How Cloud Computing Is Transforming Business and Why You Can't Afford to Be Left Behind, 2010, McGraw-Hill ISBN:9780071740753
- [17] Perhuru Raj, Cloud Enterprise Architecture, 2012, Auerbach Publications ISBN:9781466502321
- [18] Lee Newcombe, Securing Cloud Services: A Pragmatic Approach to Security Architecture in the Cloud, 2012, IT Governance ISBN:9781849283960
- [19] Alberto M. Bento, Anil K Aggarwal Cloud Computing Service and Deployment Models: Layers and Management, 2013, IGI Global ISBN:9781466621879
- [20] Tim Mather, Subra Kumaraswamy, Shahed Latif, Cloud Security and Privacy. An Enterprise Perspective on Risk and Compliance, O'Reilly United States of America, first version2009.

# The Throughput Flow Constraint Theorem and its Applications

Michael T. Todinov

Department of Mechanical Engineering and Mathematical Sciences  
Oxford Brookes University, Oxford, Wheatley,  
OX33 1HX, UK

**Abstract**—The paper states and proves an important result related to the theory of flow networks with disturbed flows: “the throughput flow constraint in any network is always equal to the throughput flow constraint in its dual network”.

After the failure or congestion of several edges in the network, the throughput flow constraint theorem provides the basis of a very efficient algorithm for determining the edge flows which correspond to the optimal throughput flow from sources to destinations which is the throughput flow achieved with the smallest amount of generation shedding from the sources.

In the case where a failure of an edge causes a loss of the entire flow through the edge, the throughput flow constraint theorem permits the calculation of the new maximum throughput flow to be done in  $O(m)$  time, where  $m$  is the number of edges in the network. In this case, the new maximum throughput flow is calculated by inspecting the network only locally, in the vicinity of the failed edge, without inspecting the rest of the network.

The superior average running time of the presented algorithm, makes it particularly suitable for decongesting overloaded transmission links of telecommunication networks, in real time. In the paper, it is also shown that the deliberate choking of flows along overloaded edges, leading to a generation of momentary excess and deficit flow, provides a very efficient mechanism for decongesting overloaded branches.

**Keywords**—networks with disturbed flows; congestion; decongestion; maximum throughput flow; telecommunication networks

## I. THE NEED FOR A HIGH-SPEED CONTROL OF FLOW NETWORKS

Although almost all real networks are networks with disturbed flows, the focus of existing research on flow networks has been exclusively on static flow networks. Research and algorithms related to static flow networks has been presented in [1-3]. The first major category of algorithms for maximising the throughput flow in networks includes the augmentation algorithms which preserve the feasibility of the network flow at all steps, until the maximum throughput flow is attained [4-5]. The second major category of algorithms are based on the preflow concept used in [6] and subsequently in [7] and [8]. The central idea behind these algorithms is converting the preflow into a feasible flow.

The best of these methods however, have a polynomial running time and do not provide the necessary computational

speed for re-optimising the throughput flow in a large and complex network in real time, after an edge failure or congestion. The main reason is that classical algorithms for maximising the throughput flow start from a network with empty edges and do not make use of special properties of the network providing a short cut to determining the maximum throughput flow.

The central question for networks with disturbed flows is how to re-optimize the network flows after an edge flow disturbance (caused by edge failure or congestion), so that a *new optimal throughput flow* is attained quickly. The concept ‘new optimal throughput flow’ means a throughput flow achieved with a minimum reduction of flow production from the flow generators (with a minimum generation shedding).

After edge failure or edge congestion, often there exists a possibility for redirecting the flow through alternative paths with non-zero residual capacity, so that a new throughput flow is reached quickly, with a minimum loss of flow. Even for relatively simple networks, it is not obvious how the edge flows should be reset in order to attain the required throughput flow, with a minimum generation shedding. Without an appropriate algorithm, the task of resetting correctly the edge flows in order to attain the new optimum throughput flow is almost impossible, for large and complex flow networks. In addition, the computational time of the algorithm must be within milliseconds, if the algorithm is to be capable of re-optimising the network flows in real time, after a contingency event. For very large networks (>10000 transmission links) an algorithm with approximately linear average running time in the size of the network is needed.

The lack of optimisation of the network flow after a contingency event leads to a severe disruption of the flow, suboptimal performance and loss of throughput flow. The importance of dynamically rerouting the traffic in telecommunication networks has been stressed in [9]. Despite the critical importance of the problem related to re-optimising the flows upon disappearance of an edge due to failure, it is difficult to find a relevant theoretical discussion. Such a discussion would provide the necessary short cut speeding the performance of algorithms calculating the re-optimised throughput flow. This problem has been mentioned in question 6.35b from [1], where the authors propose to the reader to show that after an overestimation of the capacity of an edge by  $k$  units, the labelling algorithm can re-optimize the maximum flow in  $O(km)$  time, where  $m$  is the number of edges in the network.

Disregarding the fact that the running time  $O(km)$  of the labelling algorithm is too slow for large  $k$ , the direct application of the labelling algorithm to solve this problem leads to sub-optimal solutions. This can be demonstrated immediately with the network in Fig.1, where the first number on the edges denotes the throughput capacity of the edge and the second number denotes the actual flow through the edge. Initially, the throughput flow has been maximised by using the labelling algorithm. The path (1, 2, 7) has been augmented with 40 units and path (1, 3, 6, 7) with 60 units. There are no more augmentable  $s-t$  paths and according to the Ford-Fulkerson theorem [4] the throughput flow in the network is the maximum throughput flow.

Now suppose that the capacity of edge (3,6) has actually been overestimated by 30 units and the actual capacity of the edge is only 30 units. In this case, the labelling algorithm re-optimises the flow by diminishing the flow along the  $s-t$  path (1,3,6,7) by 30 units. However, the total throughput flow in the network from the source  $s$  to the sink  $t$ , obtained by the labelling algorithm, is 70 units, which is a sub-optimal value (Fig.1b).

If before diminishing the flow along the path (1,3,6,7) an additional operation was performed, the total throughput flow would be 80 units, not 70 units. Due to constraining the flow along edge (3,6) by 30 units a “momentary excess flow” appears at node 3 and a “momentary deficit flow” appears at node 6. The network should be augmented first with the momentary excess flow of 30 units at node 3 aimed to cancel first the momentary deficit flow of 30 units at node 6. As can be seen, the maximum of 10 units momentary excess flow can be sent from node 3 to node 6 through path (3,4,2,5,6). After cancelling 10 units of flow, the remaining momentary excess flow at node 3 is 20 units and the remaining momentary deficit flow at node 6 is also 20 units. Now, by using the labelling algorithm, the momentary excess flow and deficit flow can be reduced to zero by diminishing the flow along the  $s-t$  path (1,3,6,7) by 20 units. The result is the network in Fig.1c where the total throughput flow is 80 units, which is the maximum possible throughput flow.

A similar deficiency is present in the algorithm reported in [10], treating the problem of maximising the flow in a static network by starting from a network where all edges are fully saturated with flow. This causes unbalanced *excess* and *deficit* nodes to appear in the network. The sum of the flows going into an excess node is greater than the sum of the outgoing flows while for a deficit node, the sum of the ingoing flows is smaller than the sum of the outgoing flows. The essence of the draining algorithm presented in [10] is to cancel excess flow with a deficit flow by augmenting paths starting from excess nodes and ending at deficit node. The process of cancellation of excess and deficit flow in [10] was done only in a network with a back circulation edge, connecting the sink with the source. In [11], it was shown that this approach leads to suboptimal solutions where the obtained throughput flow is feasible but not maximal. It has also been demonstrated in [11] that to achieve an optimal solution, there is a need of two distinctive stages. In the first stage, cancelling of excess and deficit flow is done in a network without a circulation edge. In

the second stage, draining of excess and deficit flow is done in a network with a circulation edge.

In short, applying the labelling algorithm without an intermediate stage consisting of cancelling as much as possible excess and deficit flow, results in sub-optimal solutions.

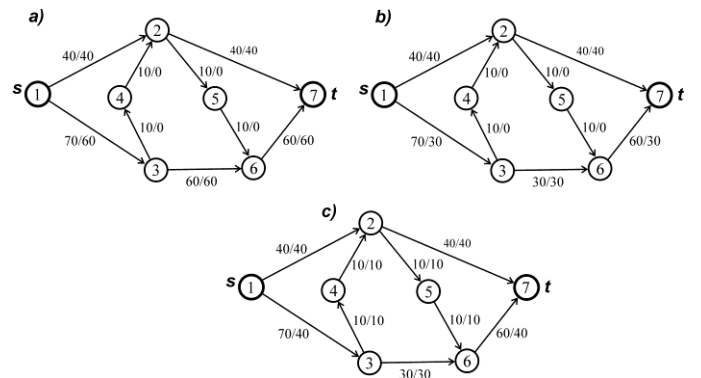

Fig. 1. Applying the labelling algorithm for re-optimising the flow after an overestimation of the capacity of an edge results in a sub-optimal solution

Component failures in flow networks and congestion are inevitable. These events lead to disappearance of flow capacity and the expected magnitude of the throughput flow from sources to destinations may not be guaranteed. As a result, the quality of service received from the network (which is a key performance characteristic) can be affected seriously.

These problems are particularly acute for telecommunication networks, oriented towards media applications, for transportation networks and power distribution networks, because they all require a high throughput flow rate. Selecting the shortest path for a data transfer, as it is commonly done [12] is often far from optimal. It is a common-sense strategy which often leads to overloading and congestion of network sections, and ultimately, to a low throughput flow.

Consequently, the objectives of this paper are: (i) to present a theoretical analysis of the important problem related to the flow constraint arising in the case of edge failures or congestion; (ii) to use the analysis for improving the efficiency of calculation of the new optimal throughput flow after failures or congestion of edges in the network and (iii) to achieve the new throughput flow in the network with a minimum generation shedding.

## II. AN NEW THROUGHPUT FLOW WITH MINIMUM GENERATION SHEDDING AFTER FAILURE OR CONGESTION OF SEVERAL EDGES

A flow network can always be modelled by a directed graph  $G = (V, E)$  consisting of a set of nodes  $V$  and a set of edges. The network flow is said to be *feasible*, if the next two conditions are fulfilled. At each node  $v_i$ , different from a source or a sink, the flow conservation law holds (equation 1).

$$\sum_{k \in \delta^+} f(k, v_i) = \sum_{m \in \delta^-} f(v_i, m) \quad (1)$$

The flow conservation law simply states that the sum of the edge flows  $\sum_{k \in \delta^+} f(k, v_i)$  entering node  $v_i$  is equal to the sum of the edge flows  $\sum_{m \in \delta^-} f(v_i, m)$  leaving the node. The second condition involves the capacity constraints imposed by the edges:

$$f(i, j) \leq c(i, j) \quad (2)$$

The capacity constraint condition simply states that the flow  $f(i, j)$  through edge  $(i, j)$  cannot exceed the capacity  $c(i, j)$  of the edge – the maximum flow that the edge permits.

The performance of an algorithm for re-optimising the network flows after failure or congestion of edges can be increased significantly in comparison with classical algorithms, which always start the maximisation of the throughput flow from a network with empty edges.

This can be done by using the important circumstance that after a disturbance of the flow along a particular edge, *the rest of the edges are not empty but are already fully or partially saturated with flow*. An algorithm which starts the re-optimisation from a network with edges which are fully or partially saturated with flow avoids the augmentation of all feasible paths and has a clear advantage to an algorithm which starts the optimisation from a network with empty edges.

In the case of a single edge failure, a method for re-optimising the flows has already been outlined in [13]. However, the critical question related to eliminating the overloading and congestion along branches of a flow network, with minimum generation shedding, was not discussed in Ref.[13]. Finally, Ref.[13] treats only the special case where the throughput flow in the network is the maximum possible throughput flow. In communication networks, electrical networks and transportation networks however, the throughput flow is rarely the maximum possible throughput flow. For real networks the central issue is to re-optimize the network flow in such a way that the contingency event causes a minimum flow generation shedding. In this sense, the notion ‘optimum throughput flow’ used here stands for the restored new feasible throughput flow in the network *attained with the smallest decrease of flow generation (generation shedding)*.

As we shall see later, the deliberate choking of flows along overloaded edges, leads to a generation of momentary excess and deficit flow and provides a very efficient mechanism of relieving overloaded branches of the network. In this respect, it is important to state and prove a result related to the magnitude of the optimal throughput flow after the flows along several edges have been constrained (choked) to a particular level.

After the choking of the flow along an edge (e.g. edge  $(e_i, d_i)$ ), from the initial level  $f(e_i, d_i)$  to the level  $f'(e_i, d_i)$  ( $0 \leq f'(e_i, d_i) < f(e_i, d_i)$ ), the network flow is disturbed

at nodes  $e_i$  and  $d_i$  to which the edge  $(e_i, d_i)$  has been connected. The flow along edge  $(e_i, d_i)$  may be fully choked because of edge failure ( $f'(e_i, d_i) = 0$ ) or partially choked ( $0 < f'(e_i, d_i) < f(e_i, d_i)$ ).

If edge  $(e_i, d_i)$  is not empty, after the choking of its flow, a momentary excess flow appears at one of the nodes (node  $e_i$ ) equal to the amount of choked flow  $f(e_i, d_i) - f'(e_i, d_i)$  along the edge. In other words, the sum of the edge flows going into node  $e_i$  is greater than the sum of the edge flows leaving the node. This difference will be referred to as ‘momentary excess flow’  $mef_i$ :

$$mef_i = \sum_{k \in \delta^+} f(k, e_i) - \sum_{m \in \delta^-} f(e_i, m) > 0 \quad (3)$$

and node  $e_i$  will be referred to as *momentary excess node*.

Alternatively, after choking the flow along edge  $(e_i, d_i)$ , momentary deficit flow will be created at node  $d_i$ , equal to the amount of choked flow  $f(e_i, d_i) - f'(e_i, d_i)$  along the edge  $(e_i, d_i)$ . The sum of the edge flows going into node  $d_i$  is smaller than the sum of the edge flows leaving node  $d_i$ . The difference between the sum of the ingoing flows and the sum of the outgoing flows is negative, and will be referred to as *momentary deficit flow*  $mdf_i$ :

$$mdf_i = \sum_{k \in \delta^+} f(k, d_i) - \sum_{m \in \delta^-} f(d_i, m) < 0 \quad (4)$$

Accordingly, node  $d_i$  will be referred to as *momentary deficit node*.

After choking the flow along  $n$  edges,  $M_1$  momentary excess nodes  $e_i$ , with momentary excess flows  $mef_i$  ( $i=1, \dots, M_1$ ) and  $M_2$  momentary deficit nodes  $d_j$  with momentary deficit flows  $mdf_j$  ( $j=1, \dots, M_2$ ), will be created. In general,

$M_1 \neq M_2$  because a momentary excess flow at a particular node from choking the flow along a particular edge may have been compensated or turned into a deficit flow by the momentary deficit flow from choking the flow along another edge incident to the node. The quantity  $\sum_{i=1}^{M_1} mef_i > 0$  is the total amount of momentary excess flow at the excess nodes, after choking the flows along the  $M_1$  edges.

The state of any node (neutral, momentary excess node or momentary deficit node) is determined by the algebraic sum of the momentary excess and deficit flows created at that node.

However, the sum of the momentary excess flows at all excess nodes is always equal to the sum of the momentary deficit

$$\text{flows at all deficit nodes: } \sum_{i=1}^{M_1} mef_i = \sum_{j=1}^{M_2} md_f_j .$$

These concepts will be illustrated by the network in Fig.2a, where the first number on each edge is the edge capacity and the second number is the actual magnitude of the flow through the edge. In the network from Fig.2a, edge (10,14) has been overloaded by 30 units of flow and the flow magnitude needs to be reduced from 60 units to 30 units. Temporary overloading of edges for example is common for electrical power networks. The flow along a power line could exceed for a short time its nominal capacity but if the flow through the line is not returned within the throughput capacity of the line, the result is a failure of the overloaded line.

After choking the flow along edge (10,14) in Fig.2a, from the initial level  $f(10,14) = 60$  to the new level  $f'(10,14) = 30$ , the network flow is disturbed locally at nodes 10 and 14 to which the edge (10,14) is connected (Fig.2a). Edge (10,14) is not empty after the choking of its flow. After choking the edge, it can be thought as if a momentary excess flow appears at one of the nodes (node 10), equal to the amount of choked flow  $f(10,14) - f'(10,14) = 30$  through the edge. In other words, the sum of the edge flows going into node 10 becomes greater than the sum of the edge flows leaving the node. This difference is the excess flow  $mef_{10}$  and node 10 becomes a momentary excess node.

Alternatively, after choking the flow along edge (10,14), a momentary deficit flow will be created at node 14, equal to the amount of choked flow  $f(10,14) - f'(10,14) = 30$  of the edge. The sum of the edge flows going into node 14 is smaller than the sum of the edge flows leaving node 14. The difference between the sum of the ingoing flows and the sum of the outgoing flows is negative, and will be referred to as a *momentary deficit flow*,  $md_f_{14}$ . Accordingly, node  $d_{14}$  becomes a *momentary deficit node*.

Now, a new start node  $s_d$  with unlimited capacity can be introduced, connected with the momentary excess node 10 (Figure 2a) through a fully saturated edge (10,  $s_d$ ) with capacity equal to the momentary excess flow at the momentary excess node 10. A new end node  $t_d$  is also introduced, connected with the momentary deficit node 14. The connecting edge ( $t_d$ , 14) is a fully saturated edge with capacity equal to the momentary deficit flow at the momentary deficit node. The result is the network in Fig.2a, which will be referred to as *dual network*.

As a result of introducing the fully saturated auxiliary edges, the momentary excess and deficit nodes disappear and feasible flow is established in all parts of the dual network. Suppose that a feasible throughput flow  $Q$  has been

established in the original network before choking the flow along edge (10,14).

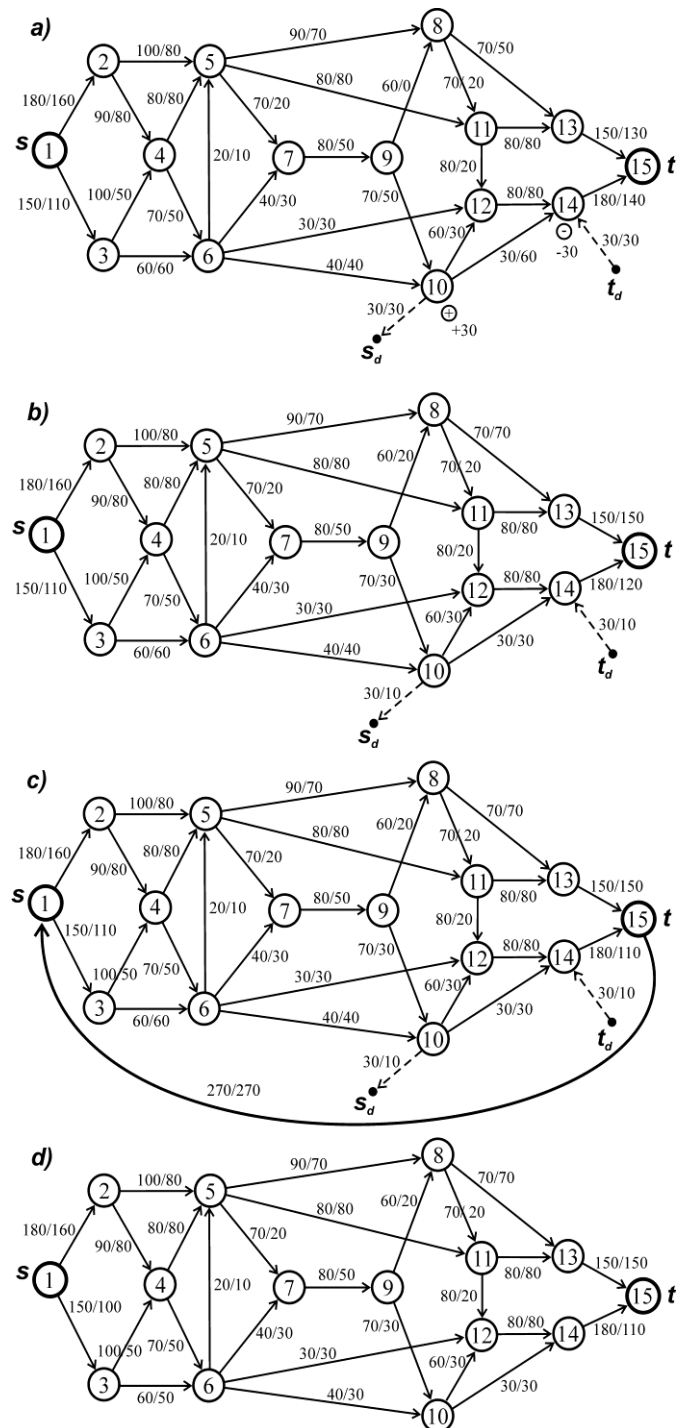

Fig. 2. The two basic stages of the fast decongestion algorithm

The algorithm for determining the edge flows corresponding to the new optimal throughput flow in the network, characterised by a minimum generation shedding, is based on the next theorem:

**Theorem 1.**



a) The edge flows corresponding to the optimal throughput flow after choking the flow along several edges can be obtained by a two-stage procedure which consists of: (i) augmenting with flow the dual network until no more augmentable paths can be found, followed by (ii) augmenting with flow the dual circulation network until no more augmentable paths can be found.

b) The optimal throughput flow in any flow network after choking the flow along several edges is equal to the throughput flow in the network before choking the edge flows, minus the total amount of momentary excess flow at the excess nodes, plus the maximum throughput flow in the dual network.

The path augmentation is a Ford-Fulkerson type augmentation [4]. In this sense, a path is augmentable if all edges along the path are characterised by a nonzero residual capacity, i.e. if no forward edge from the path is fully saturated and no backward edge is empty. For the network in Fig.2a, the path  $(s_d, 10, 9, 8, 13, 15, 14, t_d)$  is augmentable and can be augmented with 20 units of flow. The result is the network in Fig.2b. During the augmentation of paths in the dual network the original source and sink are treated as ordinary nodes. Because there are no more augmentable paths in the dual network, and there is still 10 units momentary excess flow at node 10 (Fig.2b), a circulation edge  $(t, s)$  is introduced with capacity equal to the flow (270) towards the sink (Fig.2c). The network obtained from the dual network, where the original sink  $t$  has been connected with the original source  $s$  through a circulation edge  $(t, s)$ , will be referred to as *dual circulation network* (Fig.2c).

Augmenting path  $(s_d, 10, 6, 3, 1, 15, 14, t_d)$  with 10 units of flow, removes the momentary excess and deficit flow of 10 units at nodes 10 and 14 and the flow in the network becomes feasible (Fig.2d). The flow is also optimal because the new feasible flow has been achieved with a minimum decrease of the flow production from the source  $s$  (10 units only). Note that a feasible flow could have been achieved simply by draining 30 units of flow from the network by augmenting the path  $(s_d, 10, 6, 3, 1, 15, 14, t_d)$  in Fig.2a with 30 flow units in the dual circulation network (with the circulation edge  $(t, s)$  included). This would mean however that the generation from the source  $s$  would have been decreased by 30 units (not by 10 units) hence, the throughput flow will not be optimal. Note that *augmenting the dual circulation network, before the maximum possible augmentation in the dual network has been done, leads to suboptimal solutions*. Executing the two stages of the algorithm in the correct sequence is *absolutely essential to optimizing the network flow*.

The described algorithm works equally well if choking of the flow has been done along several edges.

### III. PROOF OF THEOREM 1 AND AN ALGORITHM

Theorem 1 can be proved by using the following two lemmas, whose detailed proofs are given in the Appendix.

**Lemma 1.** *If there are no augmentable  $s_d - t_d$  paths in the dual network, the momentary excess flow at the excess nodes and the momentary deficit flow at the deficit nodes can*

*always be reduced by augmenting a  $s_d - t_d$  path in the dual circulation network, where the circulation edge  $(t, s)$  belongs to the augmented path.*

**Lemma 2.** *If no augmentable  $s_d - t_d$  path exists in the dual network, augmentation of a  $s_d - t_d$  path in the dual circulation network results in the absence of augmentable  $s-t$  paths in the original network.*

**Proof of Theorem 1.** Suppose that by augmenting  $s_d - t_d$  paths in the dual network, the entire momentary excess flow  $q_d^{\max}$  has been purged from all backward edges  $(s_d, e_i)$ ,  $(i=1, \dots, M_1)$  connecting the excess nodes  $e_i$  with the new start node  $s_d$ . Because the total momentary excess flow at the excess nodes  $e_i$  ( $i=1, \dots, M_1$ ) is always equal to the total momentary deficit flow at the deficit nodes,  $d_i$  ( $i=1, \dots, M_2$ ), eliminating the momentary excess flow will also eliminate the momentary deficit flows. In this case, the resultant throughput flow in the original network will be feasible and, at the same time, it will be equal to the initial throughput flow  $Q$ . This flow will also be optimal because the path augmentations have been done in the dual network only and no reduction of flow generation from the original source has been made.

Now, consider the second possibility: (ii) the maximum purged momentary excess flow  $q_d^{\max}$  from edges  $(s_d, e_i)$ ,  $i=1, \dots, M_1$ , in the dual network is smaller than the sum of the momentary excess flow from the excess nodes ( $q_d^{\max} < \sum_{i=1}^{M_1} m e f_i$ ).

The augmentation of  $s_d - t_d$  paths in the dual network terminates when no more augmentable  $s_d - t_d$  paths can be found. Let  $q_d^{\max}$  be the maximum throughput flow, with which the dual network has been augmented at the end of the first stage. The remaining excess flow  $q_{rem}$  to be purged from the edges connecting the excess nodes with the new start node

$s_d$  is given by  $q_{rem} = \sum_{i=1}^{M_1} m e f_i - q_d^{\max}$ . According to Lemma

1, there is always an augmentable  $s_d - t_d$  path in the dual circulation network, which reduces the remaining excess flow  $q_{rem}$ . Because an augmentable  $s_d - t_d$  path in the dual circulation network always includes the circulation edge  $(t, s)$ , each augmentation of an  $s_d - t_d$  path subtracts equal amount of flow from edges going out of the source  $s$  and from edges going into the sink  $t$ .

According to Lemma 2, after each augmentation of a  $s_d - t_d$  path in the dual circulation network, there will be no augmentable  $s-t$  path in the original network. The

augmentation of  $s_d - t_d$  paths in the dual circulation network is repeated, until the entire remaining excess flow  $q_{rem}$  from the first stage disappears. Consequently, the new throughput flow  $Q'$  after choking the flows along several edges, will be

$$Q' = Q - \sum_{i=1}^{M_1} m e f_i + q_d^{\max}, \quad (5)$$

Where  $Q$  is the throughput flow in the original network before choking the edge flows. This new throughput flow is achieved with a minimum generation shedding. Simultaneously, according to Lemma 2, there will be no augmentable  $s-t$  path in the network. According to the Ford-Fulkerson theorem [4], the absence of augmentable  $s-t$  paths in the original network means that the throughput flow in the original network is indeed the maximum possible. Consequently, the flow  $Q'$  given by equation (5) is the new optimal flow in the network, achieved with a minimal generation shedding. This proves the theorem.  $\square$

#### A. An algorithm for re-optimising the throughput flow after choking the flows along multiple edges

The algorithm for determining the edge flows corresponding to the maximum throughput flow in the network has essentially been formulated by Theorem 1. It consists of the following two basic steps:

- 1) Augment  $s_d - t_d$  paths in the dual network until no more augmentable paths can be found.
- 2) If there is still remaining flow in the backward edges connecting the new start node  $s_d$ , augment  $s_d - t_d$  paths in the dual circulation network until the remaining flow is removed.

Theorem 1 establishes a very important link between the optimal throughput flow  $Q$  in a flow network after constraining the flow capacity of an edge and the maximum throughput flow  $q_d^{\max}$  in its dual network. Theorem 1 replaces the task of determining the optimal throughput flow in the original network, with the task of determining the maximum throughput flow in the dual network. In the case of choking the flow of a single edge (for example after an edge failure), there are only two unbalanced nodes. In this case, determining the maximum throughput flow in the dual network is significantly easier than determining the maximum throughput flow in a network with empty edges. The reason for this important trade-off is that the dual network is already saturated with flow.

Because augmenting a single path or few paths is a procedure of worst-case complexity  $O(m)$  (where  $m$  is the number of edges in the network), in the cases where the momentary excess flow is eliminated after augmenting a single  $s_d - t_d$  path or few  $s_d - t_d$  paths, the running time of the proposed re-optimisation algorithm will be proportional to the number of edges  $m$  in the network. Because the momentary excess and deficit nodes, resulting from choking the flow along an edge, are adjacent nodes, in many cases, the

momentary excess and deficit flow are eliminated after a single augmentation along a single path or after augmenting few paths. The proposed algorithm has a significantly smaller average running time compared to classical algorithms starting from a network with empty edges. As it will be demonstrated later, in some cases, the algorithm re-optimises the flow in time, independent of the size of the network.

Numerous experiments with different network topologies indicated that apparently, only in extreme, deliberately designed cases, the running time of the proposed re-optimisation algorithm approaches the running time of the classical Edmonds and Karp algorithm [5]. Experiments with networks of different size and topology indicated that the average running time of the re-optimisation algorithm appears to be increasing approximately linearly with increasing the number of edges of the network.

The algorithm can also be used for a real-time control of flow networks, upon contingency events. Its high computational speed makes it appropriate for decongesting overloaded edges of networks in real time. This is particularly important for telecommunication networks, which need to be controlled within the range of milliseconds, upon congestion or failure of a transmission link. The ever increasing demand on the existing computer networks and communication networks requires a faster congestion management if the number of dropped calls, the delays caused by congestion are to be minimised. The algorithm has also important applications for real-time control of active power networks, production networks (e.g. oil and gas production networks), manufacturing networks, and supply logistics networks.

Another significant advantage of the proposed algorithm is that upon choking the flows along edges, the edge flows can be simultaneously re-optimised by several independent agents attached to the edges of the network. In this case, achieving a global maximum throughput flow from sources to destinations is guaranteed, as long as no imbalanced nodes remain in the network after the re-optimisation from the independent agents.

This point will be illustrated with the network in Fig 3a in which edge (6,5) and edge (10,12) have failed. The result is a momentary excess flow of 10 units at node 6 and 30 units at node 10, and the same quantities of momentary deficit flows at nodes 5 and 12, respectively (Fig.3a). Suppose that two independent agents one attached to edge (6,5) and one attached to edge (10,12) are independently re-optimising the throughput flow.

The agent attached to edge (6,5) is trying to cancel the momentary excess and deficit flow of 10 units at nodes 6 and 5 by sending 10 units of momentary excess flow from node 6 towards node 5. This can be done by augmenting the path (6,7,5) by 10 units of flow. The agent attached to edge (10,12) is re-optimising the flow by trying to cancel the 30 units of momentary excess flow at node 10 with the 30 units of momentary deficit flow at node 12. This can be done by augmenting the path (10,9,8,11,12) with 30 units of flow. The result is the network in Fig.3b, where the momentary excess and deficit flows no longer exist. The network flow has been re-optimised by the independent actions of the agents.

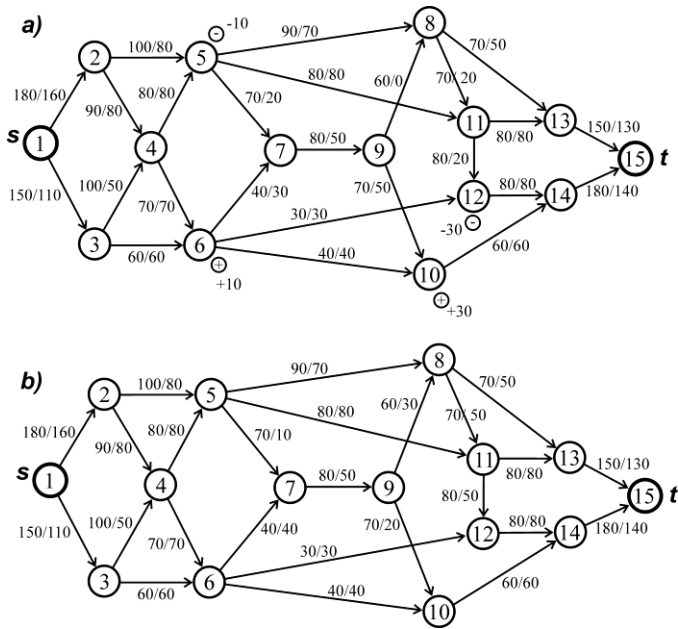

Fig. 3. The network flow can be simultaneously re-optimised by the independent actions of agents attached to the separate edges of the network

#### IV. THE THROUGHPUT FLOW CONSTRAINT

Suppose that in a particular flow network, a number of sources supply flow to a number of consumers. The total maximum amount of flow which all sources can supply is  $Q_g$ . Suppose, for the sake of simplicity, that the total amount of throughput flow transmitted to the consumers, in the absence of edge failures, is also  $Q_g$ . Because of capacity degradation, the new maximum possible throughput flow  $Q'$  transmitted through the network after edge failures is usually smaller than the maximum possible generated quantity  $Q_g$ . The difference  $Q_g - Q'$  will be referred to as *throughput flow constraint in the original network*.

Now, let us introduce a similar concept related to the dual network. The amount of momentary excess flow in the dual network is  $\sum_{i=1}^{M_1} mef_i$  and the maximum possible throughput flow from the new start node  $s_d$  to the new end node  $t_d$  is  $q_d^{\max}$ . The difference  $\sum_{i=1}^{M_1} mef_i - q_d^{\max}$  will be referred to as *throughput flow constraint in the dual network*.

Note that a network with multiple distributed sources can always be transformed to a network with a single source by linking the separate sources with a super-source, through edges whose capacities are equal to the amount of generated flow from the separate sources.

Thus, the network in Fig.4a features three sources of flow  $s_1$ ,  $s_2$  and  $s_3$ , whose flow generation powers are:  $s_1 = 15$

GB/h,  $s_2 = 20$  GB/h and  $s_3 = 30$  GB/h. The possible transmission paths and their throughput capacities have been specified as labels on the edges.

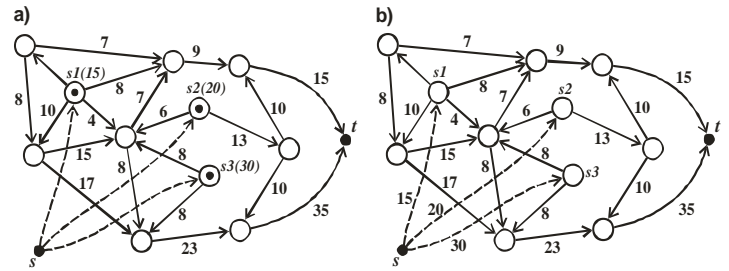

Fig. 4. Transforming a network with multiple sources of generation into a single-source network

The network in Fig.4a, with multiple sources of generation can be transformed into an  $s-t$  network (with a single source) by introducing a super-source  $s$  as it is shown in Fig.4b. The flow capacities of the edges  $(s,s_1)$ ,  $(s,s_2)$  and  $(s,s_3)$  connecting the super-source  $s$  with the sources of generation (nodes  $s_1$ ,  $s_2$  and  $s_3$ ) are equal to the flow generation power of the separate sources. As a result, the multiple sources disappear and throughput edges appear instead (Fig.4b).

It can now be shown that the following theorem holds:

#### Theorem 2. (Throughput flow constraint theorem).

*The throughput flow constraint in any network after restricting the flows along some of the edges is always equal to the throughput flow constraint in its dual network.*

#### Proof.

Suppose that the throughput flow  $Q$  is equal to the generated by the sources flow ( $Q = Q_g$ ).

According to the earlier discussion, a network with multiple sources which supplies  $Q_g$  total amount of throughput flow can always be reduced to a single source network which supplies the maximum of  $Q_g$  throughput flow. Let the new maximum throughput flow after choking the flows along some of the edges be  $Q'$ . According to Theorem 1, equation (5) holds:

$$Q' = Q_g - \sum_{i=1}^{M_1} mef_i + q_d^{\max} \quad (6)$$

After rearranging the terms, equation (6) becomes

$$Q_g - Q' = \sum_{i=1}^{M_1} mef_i - q_d^{\max}, \quad (7)$$

Which proves Theorem 2.□

For a single edge flow constraint in a saturated with flow network, it is easier to determine the throughput flow constraint in the dual network rather than the throughput flow constraint in the original network. This explains the efficiency of the optimisation algorithm working with the dual network.

Using these ideas, a similar invariant can also be formulated for static flow networks. Consider a static flow network with edges fully saturated with flow. Similar to networks with disturbed flows, excess and deficit nodes can also be defined. If the sum of capacities of all edges going into a node  $e$  (different from the source and the sink) is greater than the sum of capacities of all outgoing edges, the node is said to be an *excess node*. The amount of momentary excess flow  $ef$  at an excess node  $e$  is given by:

$$ef = \sum_{i \in \delta^+} c(i, e) - \sum_{j \in \delta^-} c(e, j) > 0. \quad (8)$$

Conversely, if the sum of capacities of all edges going into a node  $d$  (different from the source and the sink) is smaller than the sum of capacities of all outgoing edges, the node is said to be a *deficit node*. The amount of momentary deficit flow  $df$  in the deficit node is:

$$df = \sum_{i \in \delta^+} c(i, d) - \sum_{j \in \delta^-} c(d, j) < 0. \quad (9)$$

Finally, if the sum of capacities of all edges going into a particular node is equal to the sum of capacities of all edges going out of the node, the node is referred to as *balanced node*. The amount of excess/deficit flow at a balanced node is zero. Unlike the momentary excess and deficit nodes in networks with disturbed flows, the excess and deficit flows in static networks with fully saturated edges are real.

Consider now the static network in Fig.5a, whose edges are fully saturated with flow. As a result, excess and deficit nodes appear in the network: the excess node '4' with 30 units excess flow and the deficit node '3' with 20 units deficit flow. These are imbalanced nodes and the network flow is not feasible. The purpose is to make it feasible and maximise the throughput flow, by appropriate flow redistribution between excess and deficit nodes and by draining flow from the network.

Now let us connect all excess nodes (for the network in Fig.5a the only excess node is node 4) with the sink  $t$ , by fully saturated *ghost edges* directed to the sink, with flow capacities equal to the amount of excess at the excess nodes. Simultaneously, let us also connect the source  $s$  with all deficit nodes (for the network in Fig.5a the only deficit node is node 3) by fully saturated ghost edges directed towards the deficit nodes, with flow capacities equal to the deficit flows at the deficit nodes. This operation transforms the original network into a network where all internal nodes are balanced. The ghost edges have been drawn by dashed lines (Fig.5b).

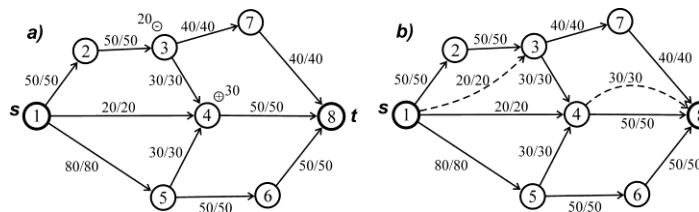

Fig. 5. By using ghost edges (the dashed lines), the excess and deficit nodes in any static flow network with fully saturated edges can be transformed into a network where all internal nodes are balanced.

After the introduction of ghost edges, the network flow is feasible everywhere (Fig.5b). In other words, the flow conservation at the nodes and the capacity constraints of the edges are honored in the network.

Now, suppose that the ghost edges in the network from Fig.5b 'fail' simultaneously. Because, by saturating all edges with flow, the throughput flow in the network has essentially been maximised, the problem is now reduced to the problem treated earlier - in a network with feasible flow several edges (the ghost edges) are choked. Because the conditions of Theorem 1 are fulfilled, it can be applied for determining the new maximum throughput flow in the network, after the 'failure' of all ghost edges. Theorem 2 will also be valid. If a dual network is now constructed, the following theorem will hold:

**Theorem 3. (Throughput flow constraint theorem for static flow networks)**

*The throughput flow constraint in any static flow network is always equal to the throughput flow constraint in its dual network.*

$$\sum_i c(s, i) + \sum_k c_g(s, k) - Q_{\max} = \sum_i ef_i - q_d^{\max} \quad (10)$$

In equation (10),  $\sum_i c(s, i)$  is the sum of capacities of all real edges coming out of the sources;  $\sum_k c_g(s, k)$  is the sum of capacities of all ghost edges coming out of the source  $s$ ;  $\sum_i ef_i$  is the sum of the excess flow formed by the 'failure' of all ghost edges in the network;  $Q_{\max}$  is the maximum throughput flow in the original network (without any ghost edges) and  $q_d^{\max}$  is the maximum throughput flow in the dual network (with failed ghost edges). Equation (10) can also be rearranged as

$$Q_{\max} = \sum_i c(s, i) + \sum_k c_g(s, k) - \sum_i ef_i + q_d^{\max} \quad (11)$$

which permits computing the maximum throughput flow  $Q_{\max}$  in static networks immediately, after obtaining the maximum throughput flow  $q_d^{\max}$  in the corresponding dual network. If there are no augmentable  $s_d - t_d$  paths in the dual network,  $q_d^{\max} = 0$  and the maximum throughput flow in the original network can be established instantly:

$$Q_{\max} = \sum_i c(s, i) + \sum_k c_g(s, k) - \sum_i ef_i$$

Because the absence of augmentable paths is established in  $O(m)$  time, where  $m$  is the number of edges in the network, the maximum throughput flow in this case will be established in  $O(m)$  time.

As a result, in some cases, the invariant throughput flow constraint theorem provides the opportunity to determine the

maximum throughput flow in a static network by inspecting the network only locally, without considering the rest of the network.

For the network in Fig.5b, the maximum throughput flow in the dual network, after the failure of the ghost edges, is  $q_d^{\max} = 20$  units. Because  $\sum_i c(s,i) = 150$ ,  $\sum_k c_g(s,k) = 20$  and  $\sum_i ef_i = 50$ , from equation (11) the maximum throughput flow becomes

$$Q_{\max} = 150 + 20 - 50 + 20 = 140$$

#### V. APPLICATION OF THE DUAL NETWORK THEOREM FOR DECONGESTING OVERLOADED TRANSMISSION PATHS IN TELECOMMUNICATION NETWORKS

Consider the telecommunication network in Fig.6a, where data is transmitted from node 1 to node 7 and where sections (1,2) and (2,5) have been congested and causing delays. To relieve congestion, the data flow along these edges should, for example, be reduced by 5 GB/h.

The first step is to choke the flows along the congested transmission links by limiting the capacities of the corresponding edges to the desired amount of flow – to 20 GB/h for edge (1,2) and to 15 GB/h for edge (2,5). As a result, momentary excess and deficit flow of 5 GB/h appears at the beginning and at the end of the edges whose flow has been choked. Node 2 however, remains a balanced node, because the momentary excess data flow of 5 GB/h from choking the flow along edge (2,5) has been cancelled canceled by the momentary deficit data flow of 5 GB/h from choking the flow along edge (1,2).

Additional start node  $s_d$  is then added, connected to the excess node '1' by the backward, fully saturated edge  $(s_d,1)$ , with capacity 5 GB/h. Similarly, additional end node  $t_d$  is also added, connected to the deficit node 5, by the backward, fully saturated edge  $(t_d,5)$ , with capacity 5 GB/h (Fig.6b). The algorithm for redistributing the flow in the resultant network, then proceeds as follows. The shortest augmentable path  $(s_d,1,3,6,5,t_d)$  is augmented with 5 GB/h, which results in the network flow from Fig.6c. The momentary excess and deficit flows disappear, the network flow is feasible; the throughput flow (35 GB/h) is equal to the throughput flow before the redistribution. The transmission links (1,2) and (2,5) however, are no longer congested.

Note, that for a long directed flow path, where the choked flow along each edge is the same, only two imbalanced nodes will appear after the choking. The start node of the directed path will appear as an excess node and the end node will appear as a deficit node. At any other node  $i$  along the directed path, the momentary deficit flow from choking edge  $(i-1,i)$  will be cancelled by the momentary excess flow from choking edge  $(i,i+1)$ . The result will be a neutral node  $i$ .

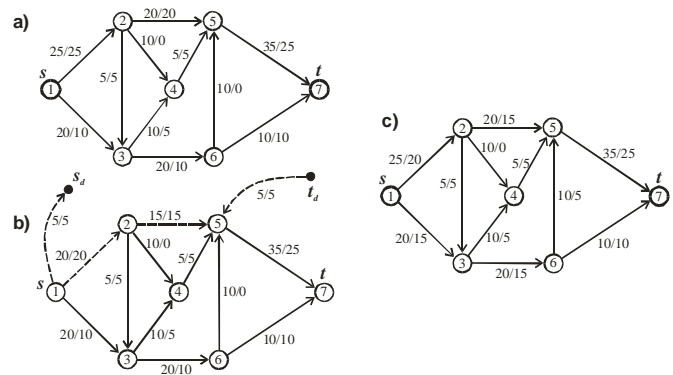

Fig. 6. Decongestion of edges (1,2) and (2,5).

In this example, the optimisation has been achieved without decreasing the generation of flow from the source. In some cases however, correcting the generated flow is necessary to avoid exceeding the permitted throughput capacities of the transmission links as in the example from Fig.2. Exceeding the permitted transmission capacities of transmission links occurs for example in overloaded power lines.

#### VI. ADVANTAGE OF THE PROPOSED METHOD TO CLASSICAL OPTIMISATION METHODS

To demonstrate the advantage of the proposed method, consider an illustration example, featuring the telecommunication network in Fig.7, where data flow of magnitude 280 GB/h is transmitted from a source  $s$  to a destination  $t$ . The capacities of the transmission lines 'c' and the actual data flows 'f' along them are shown as edge labels 'c/f'.

Suppose that the transmission link (6,5), carrying 30 GB/h, has actually been overloaded and its flow needs to be reduced from 30 GB/h to 20GB/h. According to the earlier discussion, the congestion can be eliminated by choking the flow of edge (6,5) from 30 GB/h to 20 GB/h, by reducing the capacity of the edge from 30GB/h to 20 GB/h. The throughput flow in the network after reducing the capacity of edge (6,5) (Fig.7), was re-optimised by using the classical *Edmonds and Karp* algorithm [5], which starts from a network with empty edges. For the network in Fig.7, one million runs of the Edmonds and Karp algorithm, on a computer with processor *Intel(R) Core(TM) 2 Duo CPU T9900 @ 3.06 GHz*, took 11.3 seconds.

The proposed re-optimisation algorithm from section 2 was also run on the network in Fig.7, after introducing a start node  $s_d$  and end node  $t_d$ . Because the flow through edge (6,5) before its choking was 30 GB/h, after the choking, 10 GB/h momentary excess flow will appear at node 6 and 10 GB/h momentary deficit flow will appear at node 5. Following the re-optimisation algorithm, the throughput flow in the dual network was maximised by augmenting the shortest paths starting at the new source  $s_d$  and ending at the new sink  $t_d$ . One million runs of the re-optimisation algorithm were executed for only 0.98 seconds, more than an order of magnitude faster than the running time of the classical

Edmonds and Karp algorithm working on a network with empty edges.

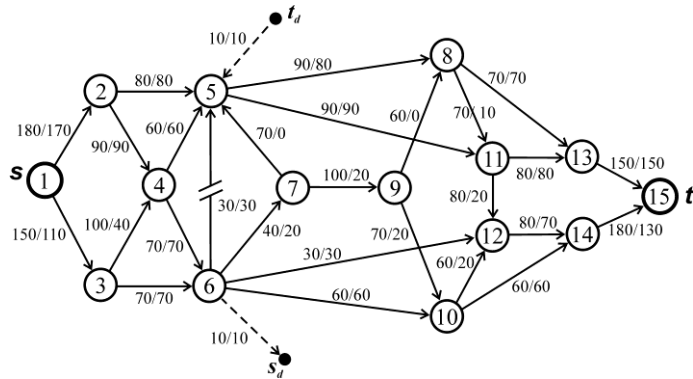

Fig. 7. A network, demonstrating the performance of the fast re-optimisation algorithm

The re-optimisation algorithm augments essentially the shortest path  $(s_d, 6, 7, 5, t_d)$  with 10GB/h. After the augmentation and the removal of the connecting edges, the momentary deficit and excess flow at nodes 6 and 5 disappear and feasible edge flows are set up everywhere in the network. The maximum throughput flow in the network after the re-optimisation is still 280 GB/h. Even if the network is increased significantly in size, by adding many nodes between node 7 and the sink  $t$  for example, the running time of the re-optimisation algorithm will not increase and will remain the same!

A fast re-optimisation of the network flow after an edge overloading or congestion is critically important for large flow networks including thousands of edges and nodes (e.g. telecommunication networks and computer networks). Restoring quickly the throughput flow minimises the flow disruption and optimises the network performance in real time. Another study conducted on a computer with a processor Intel (R) Core (TM) 2 Duo CPU T9900 @ 3.06 GHz, has indicated that after a component failure in a network with  $m=10000$  edges, an augmentation algorithm with average running time proportional to  $m^2$ , needs many seconds to maximise the throughput flow.

Indeed, for a network with 10000 edges, the average running time of such algorithm is proportional to  $(10000 \times 10000) \times \Delta t$ , where  $\Delta t = 2.5 \times 10^{-6}$  s is the average time expended on a single edge. This equates to an average running time of 250 seconds, which is unacceptable for re-optimising the flows in real-time. If the proposed re-optimisation algorithm with approximately linear average running time in the size  $m$  of the network is used, in a network with 10000 nodes, the average running time would be proportional to  $10000 \times \Delta t$  s, which means a running time of about 25 milliseconds!

The proposed re-optimisation algorithm is also very useful in cases where only the maximum throughput flow is needed but not the values of the edge flows. This application is relevant to designing fast discrete-event simulators for determining the throughput availability of flow networks by

calculating the throughput flow hundreds of thousands times, upon failures of various edges.

There are many cases where a failure of an edge causes the entire flow through the edge to be lost. For example, the entire class of networks with tree topology possesses this feature. With respect to these cases, the following theorem can be formulated:

**Theorem 4.** *If an edge failure causes a loss of the entire flow through the edge, the new maximum throughput flow can be computed in  $O(m)$  time.*

**Proof.** The excess flow associated with the failure of the edge  $(i,j)$  is equal to the flow  $f(i,j)$  through the edge. According to equation (5),

$$Q' = Q - f(i,j) + q_d^{\max} \tag{12}$$

Holds for the new maximum throughput flow  $Q'$ . Simultaneously, if the failure of an edge causes a loss of the entire flow through the edge,

$$Q' = Q - f(i,j) \tag{13}$$

From (12) and (13), it follows that  $q_d^{\max} = 0$ . In other words, there is no augmentable path in the dual network. In a connected network, discovering that there is no augmentable path is an operation with worst-case running time  $O(m)$ , where  $m$  is the number of edges in the network. Computing the expression  $Q' = Q - f(i,j)$  after discovering that  $q_d^{\max} = 0$  has running time  $O(1)$ . Consequently, the magnitude of the new maximum flow can be computed in  $O(m)$  time. □

As an illustrating example, consider the communication network in Fig.8. After the failure of edge (3,5), the new maximum throughput flow in the network has been obtained by the proposed re-optimisation algorithm. Because, there are no augmentable  $s_d - t_d$  paths in the dual network,  $q_d^{\max} = 0$  and, according to equation (5), the new optimal throughput flow after the failure of edge (3,5) is simply  $Q' = Q - f(3,5) = 180 - 30 = 150$  GB/h (Fig.8). The re-optimisation algorithm discovers that no augmentable  $s_d - t_d$  path exist in the dual network in  $O(m)$  time. One million runs of the Edmonds and Karp shortest-path algorithm for determining the maximum throughput flow (starting from a network with empty edges), took 9.3 seconds. In contrast, one million runs of the proposed re-optimisation algorithm took only 0.53 seconds, 17.5 times faster!

While the running time of classical re-optimisation methods based on maximising the throughput flow always increases with increasing the size of the network, as can be seen from the example in Fig.8, *the running time of the proposed re-optimisation algorithm does not necessarily increase with increasing the size of the network.*



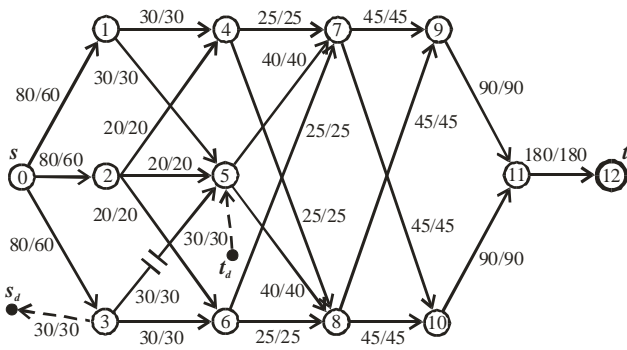

Fig. 8. The maximum flow of 150 after the failure of edge (3,5) is obtained in  $O(m)$  time, after discovering that no augmentable flow paths exist.

In the example from Fig.8, the algorithm recalculated the new maximum network flow by inspecting the network locally, in the vicinity of the failed edge, without actually considering the rest of the network. The throughput flow constraint theorem permits the recalculation of the new optimum throughput flow to be done by a local inspection of the network. This feature of the proposed method is an important contributing factor determining its high computational speed.

The re-optimisation after a failure of unreliable node can easily be reduced to the already considered case related to unreliable edges and perfectly reliable nodes. Each flow network with unreliable nodes and unreliable edges can always be reduced to a network with perfectly reliable nodes and unreliable edges. In order to do this, each node ‘ $i$ ’ of the network (Fig.9a), characterised by a failure rate (expected number of failures per unit time)  $\lambda_i > 0$ , can be presented by a pair of perfectly reliable nodes  $i1, i2$  ( $\lambda_{i1} = 0, \lambda_{i2} = 0$ ) connected with an unreliable edge  $(i1, i2)$ , characterised by a throughput flow capacity equal to the sum of the flow capacities of the edges entering node  $i$  and failure rate  $\lambda_i$ , equal to the failure rate of the unreliable node  $i$ . For each unreliable node  $i$ , the first perfect node  $i1$  collects flow from all edges entering node  $i$ . The second perfect node  $i2$  is incident to all edges leaving the unreliable node  $i$ .

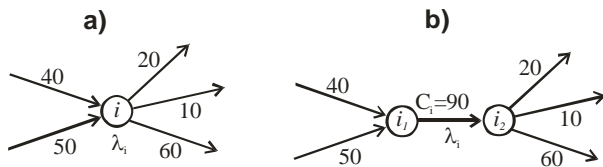

Fig. 9. Representing an unreliable node ‘ $i$ ’ by splitting it in two perfectly reliable nodes  $i_1$  and  $i_2$ , connected with unreliable edge  $(i_1, i_2)$ .

Now, the failure of the unreliable node  $i$  is treated as a failure of the unreliable replacing edge  $(i_1, i_2)$ . The advantage of this approach is that after the failure of the unreliable node  $i$ , only one excess node (node  $i_1$ ) and one deficit node (node  $i_2$ ) appear in the network.

The re-optimisation method proposed in this paper has the potential to deliver a significant improvement in the real-time control of real networks with disturbed flows, for example for telecommunication networks.

Telecommunication networks are an important example of networks with disturbed flows. The increased need for exchanging data and information is increasing the need for efficient telecommunication networks. The increased network efficiency leads to increased access, and hence an increase in network traffic. Maintaining a high quality of service during the transfer of large media files requires optimal management of the available bandwidth capacity. Finally, the telecommunication network is the backbone of the smart grid with active control of the power flows – the power network of the future [14]. In order to fulfil its function, the smart grid requires a supporting telecommunication network needed to accommodate and control the large volumes of data generated from distributed sensors, meters, generators and loads and the data flows channelled to the hardware control devices.

To improve the automation of network flows, recently, the autonomous agent-based type of control has been gaining popularity [15-18]. However, despite the intensive recent research on multi-agent systems control, currently there is a lack of algorithms for optimal flow management, which guarantees that the independent interventions of the autonomous agents upon overloading and congestion will eventually lead to a minimum generation shedding from the sources and to an optimum utilization of the residual capacity of the network. In the case of component failures, the mitigating actions from the autonomous agents are reduced to sending signals to shed load from the sources of flow. This approach requires special control systems in place, each monitoring for a different scenario and requiring a different control [15]. This approach not only leads to very complex control actions that are not at all straightforward and transparent. As the example from Fig.1 demonstrates, this approach may result in unnecessary reduction of the generated flow. As a result, this approach provides no guarantee that the optimal flows will be set up, which minimise the generation shedding and maximise the throughput flow delivered from sources to destinations.

The approach presented in this paper can be used with success for re-optimising the flow after congestion and failure by the actions of independent agents.

## VII. CONCLUSIONS

- 1) A new result has been stated and proved: “the throughput flow constraint in any network is always equal to the throughput flow constraint in its dual network”.
- 2) After choking the flow along several edges of a network, the new throughput flow is equal to the throughput flow in the network before choking the edge flows, minus the total amount of momentary excess flow at all excess nodes, plus the maximum throughput flow in the dual network.
- 3) In the case where a failure of an edge causes a loss of the entire flow through the edge, the throughput flow constraint theorem permits the calculation of the new

maximum throughput flow to be done in  $O(m)$  time, where  $m$  is the number of edges in the network.

In this case, the maximum throughput flow is determined by inspecting the network only locally, in the vicinity of the failed edge, without inspecting the rest of the network.

4) The throughput flow constraint theorem provides the basis for an efficient algorithm for determining the edge flows which correspond to the optimal throughput flow from sources to destinations – the throughput flow achieved with the smallest amount of generation shedding from the sources.

5) The deliberate choking of flows along overloaded edges, leading to a generation of momentary excess and deficit flow, provides a very efficient mechanism for decongesting overloaded branches of the network.

6) The very high average running time of the presented algorithm, makes it particularly suitable for decongesting overloaded transmission links of telecommunication networks, in real time.

7) The proposed algorithm can also be used for re-optimising the flow upon failure or congestion of edges, by independent agents.

APPENDIX

**Lemma 1** If there are no augmentable  $s_d - t_d$  paths in the dual network, the momentary excess flow at the excess nodes  $e_i$  and the momentary deficit flow at the deficit nodes  $d_i$  can always be reduced by augmenting an  $s_d - t_d$  path in the dual circulation network, where the circulation edge  $(t,s)$  belongs to the augmented path.

**Proof.** The network flow in the dual circulation network is feasible, because the flow conservation law is honored at each node and the edge capacity constraints are not violated. There are no excess and deficit nodes in the network, except at the new source  $s_d$  and at the new sink  $t_d$  (Fig.A1).

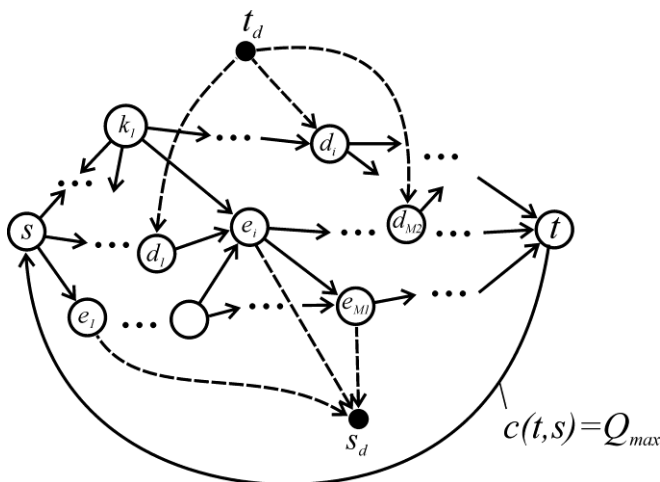

Fig. 10. Determining directed  $s_d - t_d$  paths, consisting of backward edges only.

Let us start from the start node  $s_d$ , by selecting a non-empty backward edge  $(s_d, e_i)$ , and consider the edges going into node  $e_i$ . Because node  $e_i$  is now a balanced node, if edge  $(e_i, s_d)$  carries some flow out of node  $e_i$ , there must be another backward edge  $(k_1, e_i)$  going into node  $e_i$  and carrying flow greater than zero. Let us consider the start node  $k_1$  of this edge (Fig.A1). The reasoning, which has been applied to node,  $e_i$  can now be applied to node  $k_1$  and so on, until either a visited node is reached or the end node  $t_d$  is reached. Suppose that a visited node  $v$  has been reached, before the new sink  $t_d$ . This means that a cyclic path has been encountered, consisting of backward edges only. Next, the edge carrying the smallest amount of flow belonging to the encountered directed cyclic path is identified, and its flow is subtracted from all edges of the cyclic path. During this operation, the edge carrying the smallest amount of flow becomes empty and the flow conservation law at the repeated node  $v$ , will not be violated.

Because the edge through which the repeated node  $v$  has been first reached is not part of the cyclic path, we continue from node  $v$  and the same process is repeated until no more directed cyclic paths are encountered. After each flow subtraction from the edges of the encountered directed cyclic path, at least one edge from the network becomes empty and is never filled with flow again, because only backward edges are selected for the augmented  $s_d - t_d$  path. Reaching the end node  $t_d$  is guaranteed after at most  $m$  repetitions of this process, where  $m$  is the number of edges in the network. Reaching the end node  $t_d$  is always guaranteed because all nodes in the network are balanced, except nodes  $s_d$  and  $t_d$ . Note that during this process, the  $s_d - t_d$  path must necessarily include the circulation edge  $(t,s)$ . Otherwise, it will follow that there is an augmentable  $s_d - t_d$  path in the dual network, which contradicts the condition of the lemma. □

**Lemma 2.** If no augmentable  $s_d - t_d$  path exists in the dual network, an augmentation of  $s_d - t_d$  path in the dual circulation network, results in the absence of augmentable  $s-t$  paths in the original network.

**Proof.** Consider the dual network in which there are no augmentable  $s_d - t_d$  paths, for example the dual network, immediately after the first stage (Fig.A1).

In the dual network, define a set  $A$  of nodes that can be reached through augmentable paths from node  $s_d$  (Fig.A2). An augmentable path is a path along which there are no fully saturated forward edges or empty backward edges.



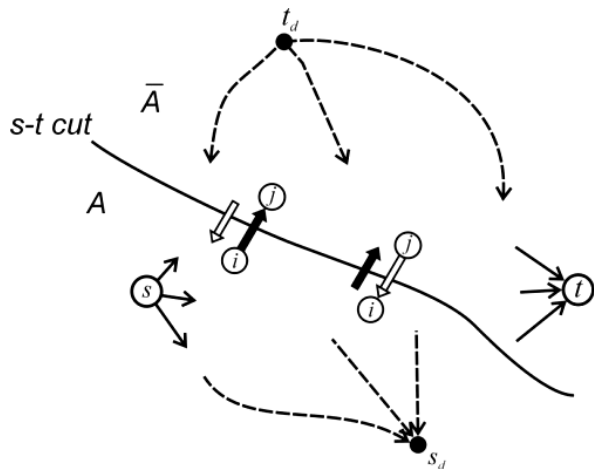

Fig. 11. An  $s-t$  cut, defined by the possibility to reach nodes from the new sink  $s_d$ .

The set  $\bar{A}$  includes all nodes that cannot be reached from  $s_d$  through augmentable paths. The new sink  $t_d$  does not belong to set  $A$  because, according to the condition of the lemma, there is no augmentable  $s_d - t_d$  path in the dual network. The original source  $s$  belongs to set  $A$  because, according to Lemma 1, there is always an augmentable path in the dual circulation network; therefore, there is always an augmentable path from the start node  $s_d$  to the original source  $s$ .

On the other hand, the original sink  $t$  does not belong to set  $A$ , because, according to Lemma 1, there is always an augmentable path in the dual circulation network from the start node  $s_d$  to the end node  $t_d$ , which includes the circulation edge  $(t,s)$ . This means that there is always an augmentable path from the original sink  $t$  to the end node  $t_d$  in the dual network. If the original sink  $t$  was reachable from  $s_d$  through an augmentable path (if the sink  $t$  belonged to set  $A$ ), the end node  $t_d$  would also be reachable from  $s_d$  and this will contradict the condition of Lemma 2, that there is no augmentable  $s_d - t_d$  path in the dual network. Consequently, the original sink  $t$  belongs to the set  $\bar{A}$ . Because a node in the network either belongs to set  $A$  or to set  $\bar{A}$  and no node can simultaneously belong to both sets,  $A \cap \bar{A} = \emptyset$  and  $A \cup \bar{A} = V$ , where  $V$  is the set of all nodes in the network. In addition,  $s \in A$  and  $t \in \bar{A}$ . As a result, the sets  $A$  and  $\bar{A}$  define an  $s-t$  cut  $A - \bar{A}$  in the original network.

Edges which cross the  $s-t$  cut from set  $A$  to set  $\bar{A}$  are fully saturated with flow while edges which cross the cut in the opposite direction, from set  $\bar{A}$  to set  $A$ , are empty (Fig.A2). Indeed, if a forward edge  $(i,j)$  crossing the  $s-t$  cut is not fully saturated with flow or a backward edge  $(i,j)$  is not empty, this

will make edge  $(i,j)$  augmentable and node  $j$  will be reachable from  $s_d$ , because node  $i$  belongs to set  $A$  and is therefore reachable from  $s_d$  through an augmentable path. Node  $j$  however, is in set  $\bar{A}$  and cannot be reached through an augmentable path from the new source  $s_d$ .

The augmented  $s_d - t_d$  path in the dual circulation network cannot possibly cross the  $s-t$  cut through a directed edge, from a node in set  $A$  towards a node in set  $\bar{A}$ , because all forward edges crossing the  $s-t$  cut are fully saturated and all backward edges are empty – therefore none of these edges can be augmented.

The augmented  $s_d - t_d$  path however may cross the  $s-t$  cut through an edge whose starting node  $j$  is in set  $\bar{A}$  and whose end node  $i$  is in set  $A$  (Fig.A3). To do so, the augmented path must either enter the  $A$  set through a fully saturated backward edge, thereby decreasing its flow, or through an empty forward edge, thereby increasing its flow (Fig.A3). After entering the set  $A$ , in order to reach the new sink  $t_d$ , the augmented  $s_d - t_d$  path must come back and cross the  $s-t$  cut again. Now, except the edge through which the  $s_d - t_d$  path entered the  $A$  set, there are no other augmentable edges crossing the  $s-t$  cut from set  $A$  to set  $\bar{A}$ , along which the  $s_d - t_d$  path can return to set  $\bar{A}$ .

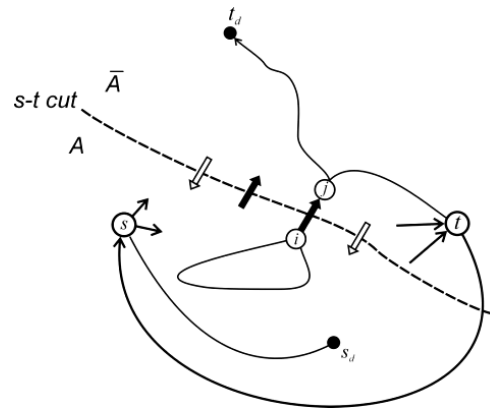

Fig. 12. An augmented  $s_d - t_d$  path in the dual circulation network

The only possibility for the  $s_d - t_d$  path to return to set  $\bar{A}$  is through the same edge through which it has entered the set  $A$ . This means that the augmented  $s_d - t_d$  path will restore the state of the edge through which it first entered set  $A$  and leave the edge in the way it was before entering the set  $A$  (Fig.A3). This is because the bottleneck flow with which the path is augmented is the same for all edges along the path. Because the augmented  $s_d - t_d$  path must reach the new sink  $t_d$ , the path can only cross the  $s-t$  cut  $(A, \bar{A})$  an even number of times. Therefore, the state of the edges crossing the  $s-t$  cut

from set  $A$  to set  $\bar{A}$  will be exactly the same as it was before the augmentation of the  $s_d - t_d$  path – fully saturated forward edges and empty backward edges. Consequently, there will be no augmentable  $s-t$  path in the original network, after the augmentation of the  $s_d - t_d$  path in the dual circulation network. This finally proves the lemma.  $\square$

#### REFERENCES

- [1] Ahuja R.K., T.L.Magnanti, J.B. Orlin, Network flows: Theory, Algorithms and Applications, Prentice Hall, 1993.
- [2] Asano T., Y.Asano, Recent developments in maximum flow algorithms, Journal of the Operations Research Society of Japan, vol.43(1), pp.2-31,2000.
- [3] Cormen T.H., T.C.E.Leiserson, R.L.Rivest, and C.Stein, Introduction to Algorithms, 2nd ed., MIT Press and McGraw-Hill, 2001.
- [4] Ford L.R. and D.R. Fulkerson, Maximal flow through a network, Canadian Journal of Mathematics, vol.8(5), pp.399-404, 1956.
- [5] Edmonds J. and R.M.Karp, Theoretical improvements in algorithmic efficiency for network flow problems, Journal of the ACM, vol.19(2), pp.248-264, 1972.
- [6] Karzanov A., Determining the maximal flow in a network by the method of preflows.,Sov.Math.Dokl., vol.15, pp.434-437, 1974.
- [7] Goldberg A.V. and R. E. Tarjan, A new approach to the maximum flow problem, Journal of ACM, vol.35, pp.921-940, 1988.
- [8] Sleator D.D. and R.E.Tarjan. An  $O(nm \log n)$  algorithm for maximum network flow. Technical report STAN-CS-80-831, Department of Computer Science, Stanford University, Stanford, CA, 1980.
- [9] J. Ahmed, F. Solano, P. Monti, L. Wosinska, Traffic Re-Optimization Strategies for Dynamically Provisioned WDM Networks; In the proceeding of the 15th International Conference on Optical Network Design and Modeling (ONDM), 2011.
- [10] Dong J., W.Li, C.Cai, Z.Chen, Draining algorithm for the maximum flow problem, 2009 International conference on communications and mobile computing, pp.197-200.
- [11] Todinov M.T., The dual network theorem for static flow networks and its application for maximising the throughput Flow, Artificial Intelligence Research, 2(1), pp.81-106 (2013).
- [12] Tanenbaum A.S., Computer networks, 4th ed., Pearson Education International, 2003.
- [13] Todinov M.T., Fast Augmentation Algorithms for Maximising the Flow in Repairable Flow Networks After a Component Failure, Proceedings of the 2011 11th IEEE International Conference on Computer and Information Technology, Paphos, pp.505-512, 2011.
- [14] Overbeeke F., Active networks: Distribution networks facilitating integration of distributed generation, In Proc. of 2nd international symposium on distributed generation: power system and market aspects, Stockholm, 2002.
- [15] Catterson V., E.M.Davidson, S.D.J.McArthur, Embedded Intelligence for electrical network operation and control, IEEE Intelligent systems, vol.26 (2), pp.38-45, 2011.
- [16] Jennings N. and S.Bussmann, "Agent-based control systems: Why are they suited to engineering complex systems?" IEEE Control Systems Magazine, vol.23 (3) pp.61-73, 2003.
- [17] Nagata T., T. Tao, K.Kimura, H.Sasaki, H.Fujita. A multi-agent approach to distribution system restoration, The 47th IEEE International Midwest Symposium on Circuits and Systems, 2004.
- [18] Saleem A. K.Heussen and M.Lind, Agent services for situation aware control of power systems with distributed generation, IEEE PES General Meeting, 2009.

# New Framework For Improving Big Data Analysis Using Mobile Agent

Youssef M. ESSA

Software Engineering Department,  
Etisalat Corporation,  
Cairo, Egypt

Gamal ATTIYA

Computer Science & Engineering  
Dept., Faculty of Electronic  
Engineering, Menoufia Uni.,  
Menouf 32952, Egypt

Ayman EL-SAYED,

IEEE Senior Member  
Computer Science & Engineering  
Dept., Faculty of Electronic  
Engineering, Menoufia Uni.,  
Menouf 32952, Egypt

**Abstract**—the rising number of applications serving millions of users and dealing with terabytes of data need to a faster processing paradigms. Recently, there is growing enthusiasm for the notion of big data analysis. Big data analysis becomes a very important aspect for growth productivity, reliability and quality of services (QoS). Processing of big data using a powerful machine is not efficient solution. So, companies focused on using Hadoop software for big data analysis. This is because Hadoop designed to support parallel and distributed data processing. Hadoop provides a distributed file processing system that stores and processes a large scale of data. It enables a fault tolerant by replicating data on three or more machines to avoid data loss. Hadoop is based on client server model and used single master machine called NameNode. However, Hadoop has several drawbacks affecting on its performance and reliability against big data analysis. In this paper, a new framework is proposed to improve big data analysis and overcome specified drawbacks of Hadoop. These drawbacks are replication tasks, Centralized node and nodes failure. The proposed framework is called MapReduce Agent Mobility (MRAM). MRAM is developed by using mobile agent and MapReduce paradigm under Java Agent Development Framework (JADE).

**Keywords**—Mobile Agent; JADE; Big Data Analysis; HDFS; Fault Tolerance

## I. INTRODUCTION

The collection of data sets are so large and complex that become difficult to process using on-hand database management tools or traditional data processing applications referred to “Big Data”. The value of big data to an organization falls into two categories: analytical use and enabling new products. Extracting information and something intelligence from these big data sets, commonly referred to as big data analytics. Big data analytics can reveal insights hidden previously by data too costly to process such as peer influence among customers, revealed by analyzing shoppers’ transactions and social and geographical data. Big data analytics is shown to be useful in several scenarios; analytics enable web data mining and enable extracting business intelligence. The primary goal of big data analytics is to help companies to make better business decisions. But, analysis of large data sets in real-time requires a framework like MapReduce to distribute the work among tens, hundreds or even thousands of computers. So, many companies focused on using Hadoop for big data analysis.

Hadoop is an open source software framework written in Java by Doug cutting and Michael Cafarella [1]. Hadoop enables distributed, data intensive and parallel applications by dividing big data into smaller data blocks. These data blocks are divided into smaller partitions such that each data block processes a different partition in parallel [2]. By using Hadoop, there is no limit of storing and processing data by computational technique called MapReduce [3] and in [4-5], the authors proposed a design of an adaptive scheme to efficiently manage the power peaks for MapReduce clusters. Hadoop provides a distributed file processing system that stores and processes a large scale of data [6]. It enables a fault tolerant by replicating data on three or more machines to avoid data loss [7-8], but this method causes some problems. The first problem is about increasing the amount of data that executes on machine by replicating each block of data in two or more machines. The second one, the full system is down when the master machine failed.

So, in this paper presents a new strategy called MapReduce Agent Mobility (MRAM) to improve big data analysis and overcome the drawbacks of Hadoop. The proposed framework is developed by using mobile agent and MapReduce paradigm under Java Agent Development Framework (JADE).JADE is a promising middleware based on the agent paradigm because it supports generic services such as communication support, resource discovery, content delivery, data encoding and agents mobility [9,10].

Indeed, there are seven reasons for using mobile agents as follows:

- 1) Reduce the network load,
- 2) Overcome network latency,
- 3) Encapsulate protocols,
- 4) Execute asynchronously and autonomously,
- 5) Adapt dynamically,
- 6) Naturally heterogeneous and robust, and
- 7) Fault-tolerant [11].

So, the mobile agent is used with Hadoop to overcome the problems faced Hadoop. In the proposed strategy, mobile agents send both code and data to any machine. The machine can react dynamically for any changes in the environment. Furthermore, if a machine or environment down, the mobile agent can migrate to another machine with code and data.

The rest of this paper is organized as follows: Section II describes Hadoop architecture, workflow, and drawbacks. Section III presents the basic concepts of JADE and Mobile Agent. Section IV introduces the proposed framework namely MapReduce Agent Mobility (MRAM). Section V presents a comparative study and performance evaluation of the proposed strategy and Hadoop. Finally, the paper is concluded in Section VI.

## II. HADOOP ARCHITECTURE AND WORKFLOW

This section presents both the architecture of Hadoop and its workflow for big data analysis as follow:

### A. Hadoop Architecture

Hadoop architecture consists of a Hadoop Distributed File System (HDFS) and a programming framework MapReduce. HDFS stores big files across machines in a large cluster. Each file is stored as a sequence of blocks. Each block is sent to three or more machines for fault tolerance. Hadoop uses MapReduce method for processing data allocated on each node [12, 13, and 14].

#### 1) HDFS

HDFS is a very large distributed file system [15, 16] that is available hardware and provides fault tolerance as well as have high throughput. Many big companies believe that within a few years, more than a half of the world's data will be stored in Hadoop. HDFS stores files as a series of blocks and replicates the data blocks for fault tolerance. HDFS is designed to store big data set, and provides global access to files in the cluster. HDFS stores metadata on a dedicated server, called "NameNode". Application data is stored on other servers called "DataNodes". All servers are fully connected and communicate with each other using TCP-based protocol [2, 15]. HDFS architecture is broadly divided into following four parts as the follows: NameNode, DataNode, JobTracker to determine the location of data and Task Tracker overseeing overall Map Reduce job execution.

##### a) NameNode

The NameNode is responsible of managing all metadata and file system actions. It handles the file system namespace operations like open, close, and renames both file and directory. Also, it makes all decisions regarding replication of blocks. NameNode maintains the tree of namespace and maps the file blocks to DataNodes (i.e. the physical location of file's data). A single NameNode is considered a bottleneck for handling requests in scientific application environments [12, 17].

##### b) DataNode

The DataNode stores data in the Hadoop file system, Each DataNode stores data blocks on behalf of local or remote clients. Each block is saved as a separated file in the node's local file system. On startup, DataNode connects to the NameNode and performs a handshake. The purpose of the handshake is to verify the name space ID and the software version of DataNode. If NameNode does not match DataNode, the DataNode automatically shuts down. After the handshake is successful, the DataNode registers with the NameNode. DataNodes persistently store their unique storage IDs. The

storage ID is an internal identifier of the DataNode which makes it as recognizable even if it is restarted with a different IP address or port. The storage ID is assigned to the DataNode, when it registers with the NameNode on the first time and never changes later. The DataNode then responds to the requests that coming from the NameNode, for the file system operations. The DataNodes service the read, writing and file replication requests based on the direction from which NameNode coming [8, 18].

##### c) JobTracker

The JobTracker talks to the NameNode to determine the location of the data. JobTracker schedules individual maps reduces or intermediate merging operations to specific machines. It monitors the success and failures of these individual tasks. Also, it works to complete the entire batch job. If a task fails, the JobTracker will automatically re-launch the task, possibly on a different node, up to a predefined limit of retries [17, 18].

##### d) TaskTracker

The JobTracker is the master overseeing the overall execution of a MapReduce job. The TaskTrackers manage the execution of individual tasks on each slave node. Although, there is a single Task Tracker per slave node, each Task Tracker can spawn multiple Java Virtual Machines (JVMs) to handle many maps or reduces the tasks in parallel. The TaskTrackers also transmit heartbeat messages to the JobTracker, usually every a few minutes, to reassure the JobTracker that is still alive [11, 17].

#### 2) MapReduce

In MapReduce [13], the first step is the map job which takes a set of data and converts it into another set of data, where individual elements are broken down into tuples (key/value pairs). The reduce job then takes the output from a map as input and combines those data tuples into a smaller set of pairs. The map function can run independently on each key/value pair, exposing enormous amounts of parallelism. Similarly, the reduce function can run independently on each intermediate key, exposing significant parallelism as well. Similar to other distributed systems, MapReduce also constitutes a master and a set of workers. The master is called JobTracker, while the workers are called TaskTrackers [14, 15].

### B. Hadoop Workflow

The workflow of Hadoop is shown in Fig. 1. It has the following steps:

- 1) *Input text files to a platform.*
- 2) *Server portioning file to blocks with the same size, then assigns a block of data to each computing node.*
- 3) *The compute node runs map on the input data and producing intermediate data pair for every word, then sends its intermediate data pairs to the node designated to perform the reduce operation.*
- 4) *The reduce operation counts the number of occurrences of each word using the values and emits it as a key-value pair.*
- 5) *Server receives the results and outputs the list.*

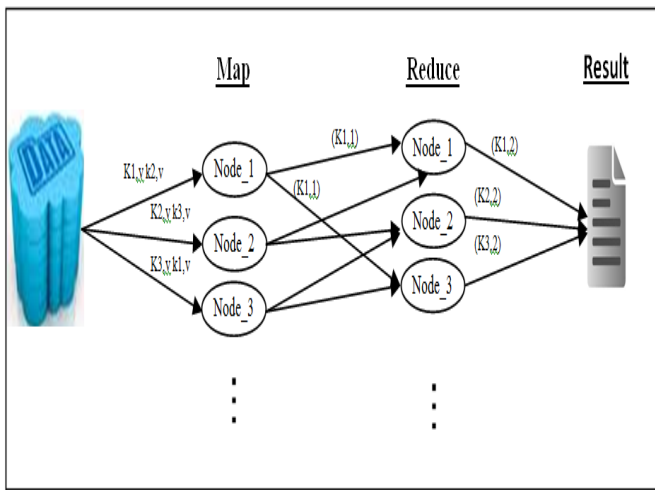

Fig. 1. Workflow for Hadoop.

### C. Hadoop Drawbacks

From the architecture of Hadoop and its workflow of data computation, there are many drawbacks of Hadoop. These drawbacks are:

- 1) Hadoop needs high memory and big storage to apply replication technique.
- 2) Hadoop supports allocation of tasks only and do not have strategy to support scheduling of tasks.
- 3) Still single master (NameNode) which requires care
- 4) Load time is long.

These drawbacks effect on both the performance and reliability of Hadoop against big data analysis. Therefore, it is necessary to develop a new framework or modify some Hadoop features to overcome Hadoop limitations and improve its performance and reliability. So, in this paper, a new framework is proposed to overcome the drawbacks of Hadoop and improve big data analysis.

## III. BASIC CONCEPTS OF JADE AND MOBILE AGENT

### A. JADE Architectural Model

In the recent years, there are many platforms that can support agent mobility and developing distributed application. JADE is a promising middleware based on the agent paradigm. It supports generic services such as communication support, resource discovery, content delivery, data encoding and so on [9,10].The architectural of JADE contains both the libraries required to develop application agents and the run-time environment that provides the basic services. These services include agent identification and agent communication. The instance of JADE is called "Container" and the set of all containers is called platform [10].

### B. Mobile Agent

A mobile agent (MA) is a software abstraction that can migrate during execution across a heterogeneous or homogeneous network. It has the ability to suspend its execution according to some factors and resume it in another machine.

**Characteristics of MA:** There are several characteristics can be defined the structure of the MA [19]:

**State:** the main characteristic of the MA. It can stop execution on one machine and resume execution on another machine. The state depends on two factors:

- 1) Execution state, which is a runtime state including its program counter and stack.
- 2) Object state, which stores the current values of its variables.

**Implementation:** it is the program code that defines the tasks behavior. If java is used as MA platform, classes present the implementation code. In this manner, there are two ways to make the required classes available to the MA:

- 1) Taking the entire required classes during its itinerary and uses it any time anywhere.
- 2) Taking some of the required classes and once the MA need a class that is not available, it retrieves it from remote location. This operation called Code-On-Demand technique, and it is a common technique in distributed network systems.

**Interface:** MA collaborates with other agents to handle the assign job. The Interface is required to make the communication possible between agents.

**Unique Identifier:** it is a unique ID define agent during its lifetime. It used as a key that needed to refer for a specific agent especially, when it travels all over the network.

**Itinerary:** it is the group of addresses created once the MA life starts that defines the agent journey around the network.

**Principals:** it is the information of individual, organization or corporation that MA belongs to. Principles are needed to authenticate the MA who dispatched to several destinations on the network.

**Advantages of mobile agent:** There are many advantages for using mobile agent to solve many problems on distributed application [9, 10].

**Reduce network traffic:** the cooperation in a distributed system is often achieved using communication protocols. These protocols transfer a large volumes of data stored at remote hosts over the network to a central processing site resulting in high network traffic. At this case, mobile agent uses alternative communication protocols.

**Off-line tasks:** network connections may be fail at any time. Agents can solved this problem by perform off-line tasks and send results to server application when it come back online.

**Support for heterogeneous environments:** MA can work on top of any operating system with the same its mobility framework.

**Fault tolerance:** Mobile agents react dynamically and autonomously to the changes in their environment. If

a host is being shut down or platform is down, all agents executing on that machine will be warned and given time to dispatch themselves and continue their operation on another host in the network [20, 21].

**Protocol Encapsulation:** Protocol encapsulation allows the components of distributed system to communicate and coordinate their activities. MAs provide a solution to the problem of upgrading the protocol code at all locations in the distributed system.

#### IV. OUR PROPOSED FRAMEWORK

Our proposed framework is called *MapReduce Agent Mobility (MRAM)*. It combines of advantages of mobile agent and MapReduce technique. MRAM framework improves big data analysis and overcomes the drawbacks of Hadoop during three steps.

##### A. First Step

Hadoop reduces CPU utilization by providing faults tolerance via replication data. The MRAM provides a fault tolerance when machine is failed by reacting dynamically to system change and can move new agent to another machine with code, data and status to continue executing task. In Hadoop, each data block is sent to three or more nodes. New strategy is completely different.

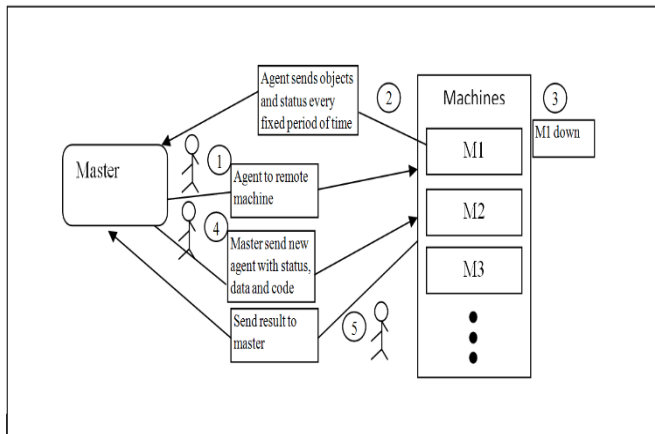

Fig. 2. Steps to solve machine fail problem.

Fig. 2 illustrates the steps to resolve this problem. The main idea of this strategy is each machine in the framework sending a copy of data and status to master machine every fixed time period. In falling machine case, another copy of agent is moving from master machine to a new machine. New agent is carrying copy of code, data and status to completion task.

##### B. Second Step

The goal of second step is comparing performance of Hadoop and MRAM. The idea of comparative study is applying the same application on Hadoop and MRAM.

The workflow of the proposed MRAM framework is shown in Fig. 3. It has the following steps:

- 1) *Input text files to the platform.*

- 2) *Server portioning the file to blocks with the same size*
- 3) *An application server assigns a data block to each computing node, but in our approach the server take a task as the other nodes.*

4) *The computing node runs map on the input data and producing intermediate data pair for every word. It then sends its intermediate data pairs to application server directly to perform the reduce operation.*

5) *The reduce operation counts the number of occurrences of each word using the values and emits it as a key-value pair and save the result in file or in consol.*

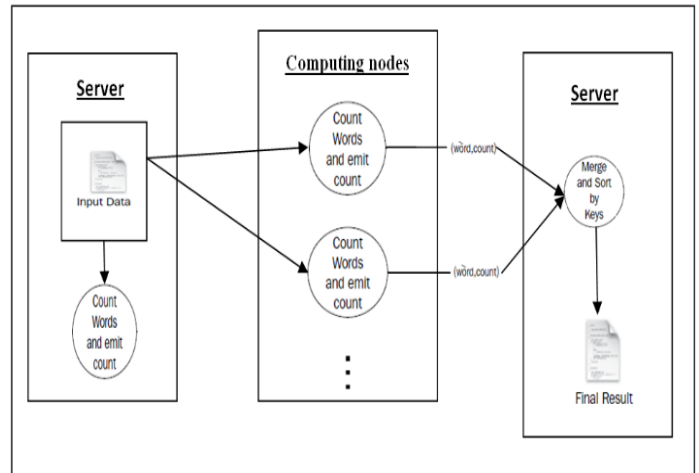

Fig. 3. MRAM Workflow.

##### C. Third Step

This step uses features of mobile agent. Mobile agent can react dynamically and autonomously to change in their environment. Hadoop is still depending on single node that runs all the services needed to MapReduce task distribution and tracking. The all system is down when a single node is failed or down. The solution of this problem, the master node is selected when a platform starts working. After that, the master node build linked list involves meta-data. These meta-data contains all information about tasks, dependences among them and information about all machines.

Also, the master machine sends meta-data to all machines through network connection. Subsequently, if any node receives a job, this node is elected as a new master. When the master machine is shutdown or platform is down, all agents executing on master machine will be moved to another host that having a highest IP-address when meta-data is published. The agents continue executing tasks on new machine because it carrying its code, status and data.

A new machine becomes as a master node that is responsible for all acts of server expects to receive result from machines such as Task Tracker and informs all machines about a machine failed. After all agents finished executing tasks, it is waiting to send the result to general server when it comes back online as shown in Fig. 4.



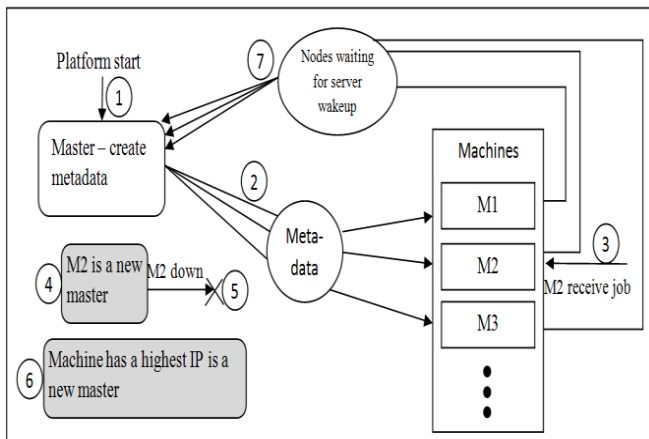

Fig. 4. Steps to solve centralized node problem.

#### D. Advantages of MRAM

The MRAM framework has several advantages derived from the features of mobile agent and MapReduce technique. The advantages of MRAM are:

- 1) Support allocation and scheduling tasks.
- 2) Provides fault tolerance and don't need high memory or big disk to support it.
- 3) Load time for MRAM is less than that of Hadoop.
- 4) Solve single master (centralized node) problem by using features of mobile agent.
- 5) Improve execution time because of no need to huge processing to replication data.

#### V. COMPARATIVE STUDY AND PERFORMANCE ANALYSIS

It is noted that MRAM improves reliability of Hadoop using mobile agent and investigate the performance of Hadoop and MRAM. The idea of comparative study is applying the same application in the same environment on Hadoop and MRAM.

##### A. Implementation Environment

In this paper, the Measurements have been carried out by using the following hardware and software components. The specifications of the used hardware and software are shown in Table I, and as follows:

1) *Hardware Components:* Hardware contains one server namely "Server" and three nodes namely "PC1", "PC2" and "PC3" connected via a LAN.

2) *Software Components:* Hadoop and MRAM are the main software components. The word count application or multiply two arrays application is applying on each platform.

##### B. Durability of platforms

As mentioned before, there are three weaknesses for Hadoop. The first weakness, Hadoop is still single master which require care. The second one, Hadoop reduces the CPU utilization by providing faults tolerance via replication data.

TABLE I. SOFTWARE AND HARDWARE EQUIPMENTS

	Server	PC1	PC2	PC3
<b>Model</b>	<b>IBM x3650</b>	<b>IBM</b>		
<b>CPU</b>	Intel Dual Core2Quad 2.56 GHZ	Intel Dual Core2Due 2.53 GHz		
<b>RAM</b>	16GB	2 GB		
<b>Hadoop version</b>	0.20	0.20		
<b>OS</b>	Linux	Linux		
<b>Sun JRE</b>	JRE 7u25	JRE 7u25		
<b>JADE</b>	4.1	4.1		

TABLE II. DATA ABOUT STATES OF TASK.

Time interval in second	0.25	0.5	1	2	4	8
1 <sup>st</sup> snapshot of objects	i=1 j=1988	i=1 j=1983	i=1 j=2088	i=1 j=2001	i=1 j=2001	i=1 j=1912
Last snapshot	i=3 j=2240	i=5 j=1255	i=8 j=338	i=17 j=150	i=38 j=613	i=65 j=2236
Last status sent	i=1 j=1886	i=2 j=1246	i=4 j=1676	i=8 j=2420	i=19 j=1271	i=37 j=871

Sure, these factors effect on the reliability of Hadoop. So the solution is via mobile agent as in MRAM and will clarify each solution separately as follow.

##### 1) Faults Tolerance Techniques

Table II contains the data used to measure the appropriate times periods that sends the in all of them the data and status about tasks. The Framework is using two arrays each one consist of two-dimensional. Theses matrix is multiplying in this step and measuring execution time in different states. First dimension is defined by i and second dimension by j.

The status and data takes in each time period for each array. So, the first measurement value takes after the program began, and then used a fixed period of time to take the status and data of the task. We assume the worst case that occurs if a machine is down just before taking a status and data. All values in table on the basis of this case.

From the Table II, the relationship between time and the amount of data processing is a proportional relationship. Also, the relationship between time and amounts of processes losses is proportional relationship.

Fig. 5 illustrates size of sent data in every period of time, where the amount of data sent is decreased when the period of time increased. But this in turn affects the reliability of the system because when the time period increased will be the possibility of processes losses are larger as shown in Fig. 6. Also, the time needed to send data is greater when the amount of data sent is increased.

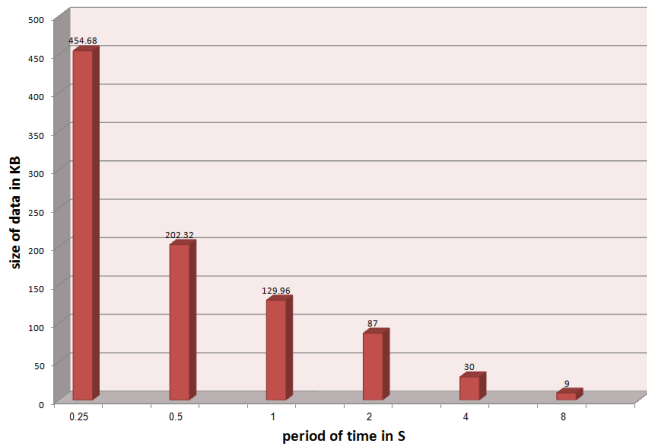

Fig. 5. Effects on Sent data size when using various time periods.

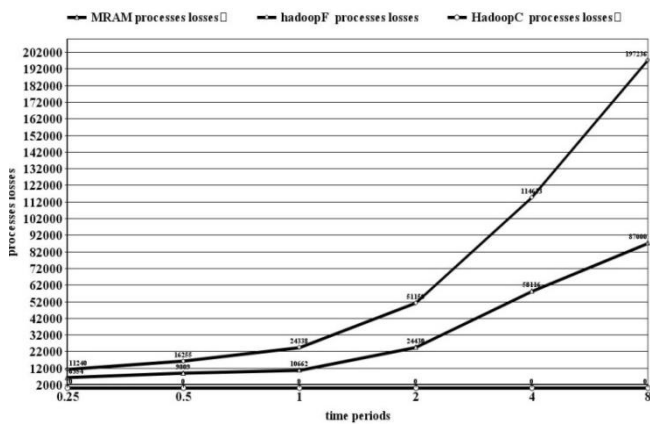

Fig. 6. Processes losses comparison in different platforms.

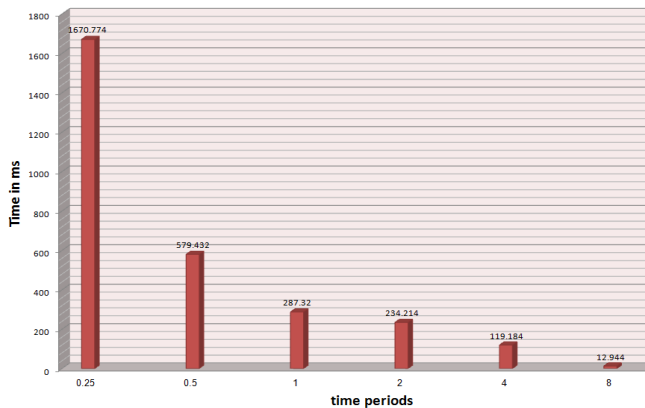

Fig. 7. Effects on Exchange data time when using various time periods.

Based on the above factors, the framework finds the best fixed period of time used in the application is to be transfer data every second. So, the amount of losses processes rates is slightly larger for periods prior to them. In addition, we find the amount of losses processors increases in the periods after which at high rates of up to more than double. When uses a 0.5 second, the losses processes less than a second. But, if we look at other factors we find at 0.5 second the amount of data sent is larger and thus data sent takes a longer period of time to send as shown in Fig.7.

In Hadoop, there are two techniques uses to executing task when a machine is failed. In first technique, the first copy of task starts processing after replicas tasks. But when this machine down the second copy of task is start executing from the beginning. Also, the third copy of tasks is beginning executing when the second machine is failed. The first technique is referred to “HadoopF”. In contrast, the idea of second technique is the all duplicates task are start working concurrently after replication process. HDFS takes the first copy of task was executed and cancelled another copies of task. The second technique is referred to “HadoopC”.

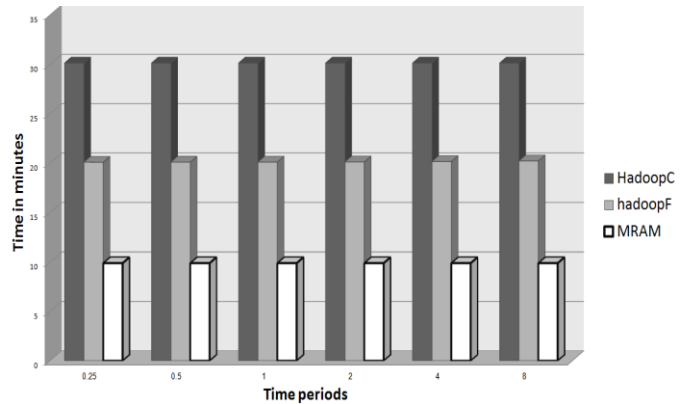

Fig. 8. Cost values for HadoopF, HadoopC and MRAM when a machine is failed.

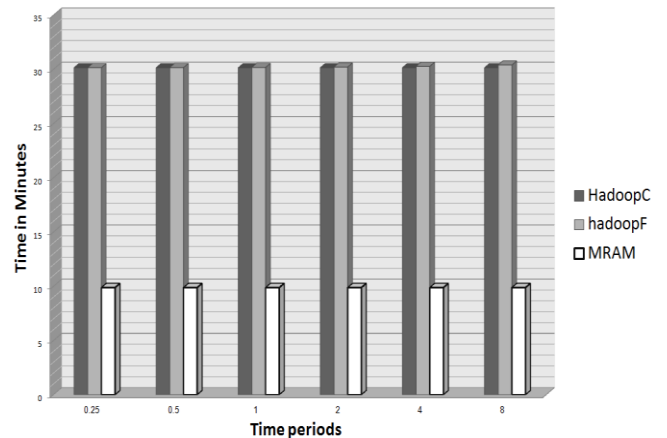

Fig. 9. Cost values for HadoopF, HadoopC and MRAM when two machines are failed

The cost values for MRAM, HadoopF and HadoopC is described in two cases: The first case when one machine is failed shown in Fig. 8 and second case when two machines are failed shown in Fig. 9. The cost is defined by “time”. Indeed, the execution time of MRAM is 6.10805 minutes and Hadoop is 6.48875 minutes in optimum system. HadoopF cost is the total time spent in executing task on machines before its failing and this time is referred to (tf). Also, the time spent in executing task on the final machine is added to cost and this time is referred to (ts). In addition to that, the time between the first machine fall and the task beginning in the second machine is added to cost and this time is referred to (tcom). The cost of HadoopF is described by the equation (1).



$$Cost_{HadoopF} = \sum_{Machine=0}^2 (t_r + t_s + t_{com}) \quad (1)$$

HadoopC cost is completely different from HadoopF because all replicas tasks in HadoopCare working concurrently. In this scenario, HDFS takes the result from the first task has been executed. The time spent from task executed in fastest machine is referred to ( $T_{fa}$ ). HDFS cancels all others duplicated task and total cost is the summation of time used in all machines until the fastest machine has been finished to executing task. The cost of HadoopC is described by the equation (2).

$$Cost_{HadoopC} = 3 * T_{fa} \quad (2)$$

The cost of MRAM is dependable on the execution time for task ( $T_e$ ) and total communication time between machines ( $T_c$ ) and it is described by the equation (3).

$$Cost_{MRAM} = T_e + \sum_{Machine=0}^2 T_c \quad (3)$$

In Fig.8, the MRAM framework is the lowest cost when one machine is failed. Also, we see that the HadoopF cost is less than HadoopC because the cost of HadoopC is summation of time from all duplicated task in three machines. In HadoopF, the cost value is the summation of execution time in two machines only.

From Fig.9, the MRAM is the lowest cost from HadoopF and HadoopC when two machines are failed. The reason for that, MRAM does not lose the output data and status because there is another copy of them sent to the master machine. Indeed, the cost of HadoopF is larger than HadoopC due to the HadoopF adds the time spent between machine fall and starts task execution on another machine to total cost.

### 2) Performance Analysis

The word count application is applying on each platform in this step. It is a simple program given a text file and count repeated time for each word, after that save the output as a list in the form of (<Word>, <Count>). It is possible to process each line of a text file completely independently on the other lines. The data then is combined in a central location and the results are printed out. The idea to evaluate the performance of two platforms is measure total time takes to complete assign job. The complete job is executed with different size of data on both Hadoop and MRAM. The execution time for each state is calculated. The load time and mapping task for Hadoop is larger than load time for MRAM because Hadoop takes time for replication processing. It means that each task is sent to three or more machines for fault tolerance, but in MRAM the task sent to only one machine and the mobility supports fault tolerance without needing for replication task. Also, the two platforms using the same algorithm map reducing to evaluate execution time. The total time in MRAM is less than that of Hadoop as shown in Fig.10. MRAM gives the possibility for the server or control node to execute task as another nodes in platform, but not exist in Hadoop.

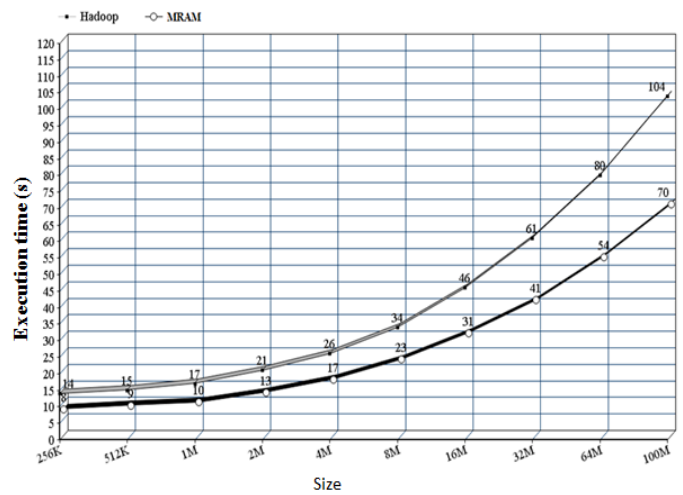

Fig. 10. Performance comparison between MRAM and Hadoop.

### 3) Centralized Node

This step uses word count application. The total time as shown in Fig.11 is composed from the execution time, the time spent from master machine to reconnect again and the time required from new master to work this time is based on the number of times master failed. The value of the time needed from master machine to reconnect is fixed and assumed the master machine is failed one time. This technique is described by the equation (4).

$$T_{Total} = T_{execution} + T_{Migration} + T_m + T_{startup} \quad (4)$$

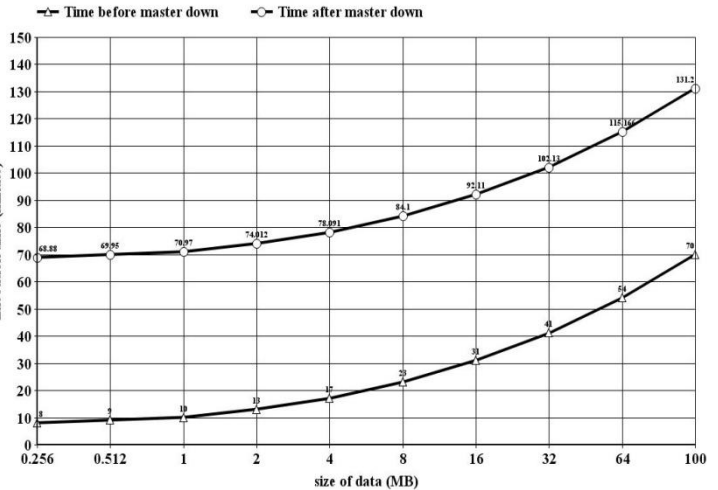

Fig. 11. Performance of MRAM when master machine failed.

Where the Migration time ( $T_{Migration}$ ) is the time required for the agent migrating from the master machine to the target machine and his return.  $T_m$  is the time spent from master machine to back online again. The startup time is the time spent from new master to start work, this time is based on the times of master machine failed. The word count application was applied in this step and has been assumed  $T_m = 1$  minute.

#### 4) Summary of results

Table III illustrates the differences between Hadoop and MRAM through the fetched results from experiments. The table shows various comparative factors such as architecture, startup time, performance, reliability, and the mobility support, and ... etc.

TABLE III. SUMMARY ABOUT DIFFERENCES BETWEEN TWO PLATFORMS

Factors	Platforms	
	Hadoop	MRAM
Architecture	Client/Server	Distributed Agent
Startup time	Long	Less
Performance	Less	Better
Reliability	Reliable	More Reliable
Algorithm	Map-Reduce	Map-Reduce
Mobility	N/A	Support
Management disk	Support	N/A
Allocation Tasks	Support	Support
Scheduling Tasks	N/A	Support
Methodology	Object-Oriented	Object-Oriented
Language	Java	Java

## VI. CONCLUSION

In this paper, a new framework called MRAM is developed using mobile agent and Map Reduce paradigm under JADE. Our proposed framework is developed to improve big data analysis and to overcome the drawbacks of Hadoop. In the proposed Framework, mobile agents send both code and data to any machine and react dynamically for any changes in environment. In addition, the mobile agents have ability to move with code and data, if the machine or environment is down. Furthermore, Hadoop is still single master which requires care, this *problem* is solved in MRAM through send met-data contains map of network and all data about tasks and dependences between them. Also, MRAM improves performance by giving the server or control node, the possibility to execute tasks as the others nodes. Another disadvantage of Hadoop, it doesn't support scheduling tasks or does not work with dependent tasks, but MRAM support this feature. A new strategy is written in JAVA programming language based on JADE, This means it can run on different machines and different operating system without any problems.

### REFERENCES

[1] Hadoop web site, <http://hadoop.apache.org/>, Jan. 2014.  
[2] Kala Karun. A, Chitharanjan. K, "A Review on Hadoop-HDFS Infrastructure Extensions", In Proceedings of IEEE Conference on

Information and Communication Technologies (ICT2013), pp.132-137, 11-12 April, 2013, doi: 10.1109/CICT.2013.6558077.  
[3] Jian Tan, Xiaoqiao Meng, Li Zhang, "Coupling Task Progress for MapReduce Resource-Aware Scheduling", In Proceedings of IEEE INFOCOM, pp.1618-1626, 14-19 April, 2013, doi: 10.1109/INFOCOM.2013.6566958  
[4] Zhu, Nan; Liu, Xue; Liu, Jie; Hua, Yu, "Towards a cost-efficient MapReduce: Mitigating power peaks for Hadoop clusters," Tsinghua Science and Technology, vol.19, no.1, pp.24,32, Feb. 2014 doi: 10.1109/TST.2014.6733205.  
[5] Anchalia, P.P.; Koundinya, A.K.; Srinath, N.K., "MapReduce Design of K-Means Clustering Algorithm," International Conference on Information Science and Applications (ICISA), pp.1,5, 24-26 June 2013, doi:10.1109/ICISA.2013.6579448.  
[6] S. Ghemawat, H. Gobioff, and S. Leung. "The google file system", In Proceedings of the nineteenth ACM symposium on Operating systems principles", SOSP '03, pp. 29-43, New York, NY, USA, 2003.  
[7] Yongwei Wu; Feng Ye; Kang Chen; Weimin Zheng, "Modeling of Distributed File Systems for Practical Performance Analysis," IEEE Transactions on Parallel and Distributed Systems, vol.25, no.1, pp.156-166, Jan.2014, doi:10.1109/TPDS.2013.19.  
[8] K.Shvachko, H.Kuang, S.Radia, R.Chansler, "The Hadoop Distributed File System", 26th IEEE symposium on Mass Storage Systems and Technologies (MSST), pp.1-10, 3-7 May, 2010.  
[9] JADE web site, <http://JADE.tilab.com>, Jan. 2014.  
[10] F. Bellifemine, G. Caire, A. Poggi, G. Rimassa, "JADE: A white paper", TILAB Journal, Vol.3, No.3, pp.6-19, 2003.  
[11] D.Schoder, T. Eymann, "Technical opinion: The real challenges of mobile agents", Communications of the ACM, Vol. 43, No. 6, pp. 111-112, June 2000.  
[12] G.Mackey, S.Sehrish, J.Wang, "Improving Metadata Management for Small Files in HDFS", In Proceedings of IEEE International Conference on Cluster Computing and Workshops, pp.1-4, 31 Aug.- 4 Sept., 2009.  
[13] J. Dean, S. Ghemawat, "MapReduce: A Flexible Data Processing Tool", Communications of the ACM, Vol.53, No.1, pp.72-77, January, 2010.  
[14] V.Martha, W.Zhao, Xiaowei Xu, "h-MapReduce: A Framework for Workload Balancing in MapReduce", IEEE 27th International Conference on Advanced Information Networking and Applications, pp.637-644, 25-28 March, 2013.  
[15] J.Shafer, S.Rixner, Alan, "The Hadoop Distributed Filesystem:Balancing Portability and Performance", In Proceedings of IEEE International Symposium on Performance Analysis of Systems & Software (ISPASS), pp.122-133, 28-30 March, 2010.  
[16] K. Shvachko, H. Kuang, S. Radia, R. Chansler, "The Hadoop Distributed File System", 26th IEEE Symposium on Mass Storage Systems and technologies(MSST), pp. 1-10, 3-7 May, 2010.  
[17] C.Lam, "Hadoop in Action", Manning Publications Co., USA,ISBN:9781935182191, Dec. 2010.  
[18] S.Perera, T.Gunarathne, "Hadoop MapReduce Cookbook", Packt Publishing, ISBN:1849517282,Jan. 2013.  
[19] D. Lange, M. Oshima, "Programming and Deploying Java Mobile Agent with Aglets", Addison-Wesley, pp.18-20, 1998.  
[20] P. Braun and W. Rossak, "Mobile Agents – Basic Concepts Mobility Models and the Tracy Toolkit", Morgan Kaufmann Publishers, 2005.  
[21] L. Guanyu ; W. Baofeng; Y. Yang; A. Lihua , "Researches on Performance Optimization of Distributed Integrated System Based on Mobile Agent", The Sixth World Congress on Intelligent Control and Automation, pp. 4038- 4041, June 2006.

# Distributed programming using AGAPIA

Ciprian. I. Paduraru  
Department of Computer Science,  
University of Bucharest  
Bucharest, Romania

**Abstract**—As distributed applications became more commonplace and more sophisticated, new programming languages and models for distributed programming were created. The main scope of most of these languages was to simplify the process of development by providing a higher expressivity. This paper presents another programming language for distributed computing named AGAPIA. Its main purpose is to provide an increased expressiveness while keeping the performance close to a core programming language. To demonstrate its capabilities the paper shows the implementations of some well-known patterns specific to distributed programming along with a comparison to the corresponding MPI implementation. A complete application is presented by combining a few patterns. By taking advantage of the transparent communication model and high level statements and patterns intended to simplify the development process, the implementation of distributed programs become modular, easier to write, in clear and closer to the original solution formulation.

**Keywords**—*patterns; parallel; distributed; AGAPIA; fork; join; control; scan; wavefront; map; reduction; pipeline; scatter; decomposition; gather*

## I. INTRODUCTION

Distributed programming is usually considered both difficult and inherently different from serial or concurrent centralized programming. Different high-level programming languages and models were created in order to increase expressiveness and productivity. This paper presents AGAPIA language in an attempt to add even more expressivity to the distributed programming. By taking advantage of the transparent communication model and high level statements intended to simplify the development process, the implementation of distributed programs become modular, easier to write, in clear and closer to the original solution formulation. Because the AGAPIA code is composed mostly from C language code plus a few specific language constructs and specifications it is expected that users can easily understand this new language.

The demonstration of the AGAPIA language potential is demonstrated through the implementation of some of the well-known patterns in the distributed computing along with a real example application and its performance results. Patterns are a way of codifying best practices for software engineering. Identifying themes and idioms that can be codified and reused to solve specific problems in parallel and distributed computing is an important topic in computer science. The semantics of each pattern is the same for every programming language, but the way to implement it differs between programming languages. When dealing with parallel and distributed programming the user has to take an important

decision when choosing the programming language because each one has its own advantages and disadvantages. In this paper, by "parallel implementation" we understand both parallel implementations with shared memory and distributed computing. Actually, most of the programs in AGAPIA have the same source code for both shared and distributed memory models - the exceptions are when users want to take advantage of the shared memory and use it without retransmitting data.

The paper is organized as follows. In Section 2 there is a short description of AGAPIA language, some explanations about its executing semantics that are important for understanding the next sections and a comparison to existing solutions. In Section 3 patterns are presented one by one. A more complex example by combining some of these patterns is given in Section 4. Concluding remarks are in Section 5.

## II. AGAPIA LANGUAGE

### A. Motivation for AGAPIA and a comparison with other solutions

This section provides a short motivation why AGAPIA is a good solution for parallel computing, a comparison with other solutions, a presentation of previous papers and an idea about how the execution process is made.

In the process of writing programs for parallel systems with distributed memory, using a common language such as MPI, users are concentrating on a set of sequential steps and needs to create multiple tasks that can run concurrently, and then handle their communications and synchronization explicitly. Before doing the implementation in a programming language, users are thinking on the architecture of the program as something more appropriate to a data flow diagram [12] where different entities are computing and exchanging data. Because of the sequential style to write a program, it is often hard to understand exactly what the interactions between the entities are. This could cause the program to be error prone, to have low modularity and difficulties to understand its communication.

The objective of APAGIA language is to allow users create inherently parallel programs, with the same code structure for both shared and distributed memory models, with minimal coding and impact over performance. The gains would be less time to implement a program because a data flow diagram is similar to how a user generally thinks about a program, transparent communication, better modularity and less error prone. Gamma calculus model [11] is another solution for inherently parallel programming with minimal code. Gamma is a kernel language in which programs are

described in terms of multiset transformations. However, the implementations in this presentation will show that AGAPIA programs are easier to understand, being more appropriate to common parallel programming languages that users know, because it uses C/C++ for most of its code and just adds some high level statements and operators for parallel coordination.

In [2], AGAPIA v0.1 was described as being a kernel programming language for interactive systems. It contains a detailed presentation of the language syntax and a toy example of dual-pass termination detection protocol. In [3], the syntax is extended to allow for the construction of high-level structured rv-programs. The new version of the language is v0.2 and supports recursion and dynamic programs creation. This paper is based on the latest version of AGAPIA, v0.2. To create high-level programs, AGAPIA provides composition operators, conditional and iteration statements.

**B. Basics of AGAPIA programming**

The basic block in AGAPIA programming is the module. A module has four input/output interfaces. The input can be received in north and west while output could go to east and south. Each interface could contain zero, one or more variables. A module's interface could be represented as a tuple of interfaces: (west; north;east;south). The interface of the module in Fig. 1 is ( int,string ; nil ; int ; int ). By specifying nil to an interface we are actually ignoring it.

```

module main { listen a : int, s:string } { read nil }
{
    // ..source code for program..
} { speak b : int } { write c : int }
    
```

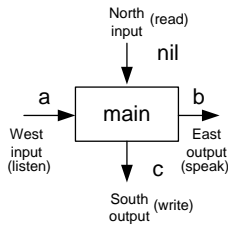

Fig. 1. Simple program in AGAPIA.

To obtain higher-level programs, the basic operation for the user is to use the composition operators. In the pictures below all the three composition operators that can be defined over two programs A and B are shown, along with the necessary restrictions and resulted interfaces.

- Vertical (Temporal) composition: A%B. Resulted program interface is:

(west(A) U west(B); north(A); east(A) U east(B); south(B)).



Fig. 2. Vertical composition. South(A) should match North(B)

- Horizontal (Spatial) composition: A # B. Resulted program interface is:

(west(A); north(A) U north(B); east(B); south(A) U south(B))

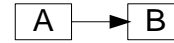

Fig. 3. Horizontal Composition. East(A) should match west(B).

- Diagonal composition: A \$ B. Resulted program interface is:

(west(A); north(A); east(B), south(B)).

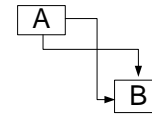

Fig. 4. Diagonal composition. Both output interfaces of A should match the input interfaces of B.

Two types of dependencies can be defined between modules:

- north-south (or read-write) dependency: can occur in the vertical or diagonal composition.
- east-west (listen-speak) dependency: can occur in the horizontal or diagonal compositions.

A dependency exists if the interface on the corresponding side is not nil. Dependencies are usefully when coordinating the execution and preventing a program being executed before another one. For example, the diagonal composition could have both types of dependencies and it can be usefully when implementing barriers.

The modularity of the language is given by the fact that a module implementation can be re-used in another application just by matching the correct interfaces. Also, at any time a user can change a module implementation with another one with the same interfaces. Making a comparison to general object oriented languages, a module change is like replacing an existing class with another one which have the same operations and data. However this is even easier in AGAPIA because the only specification of a module is contained in its input/output interfaces, while the entire semantics is contained inside the module. The original syntax of AGAPIA v0.2 language was modified in order to make it friendlier to users. In Fig. 5 the new syntax is presented. As the syntax is defined, a module becomes a program at a higher-level.

**Interfaces**

SI ::= nil | int | bool | float | string | buffer |  
 | (SI, SI) | (SI [] )

MI ::= (SI) | (SI;SI) | (SI;)\*

**Expressions**

V ::= x : MI | V(k)  
 | V.k | V.[k] | V@k | V@[k]

E ::= n | V | E + E | E \* E | E - E | E/E

B ::= b | V | B&&B | B || B | !B | E < E

## Programs

```

W ::= null | new x : SI
    | x := E | if (B) { W } else { W }
    | W;W | while (B) { W } ... (and all
other C language constructs)

M ::= module module_name
    [MI – optional]{listen x:MI}{read x:MI}
    { W } {speak x : MI}{write x : MI}

P ::= nil | M | if (B) { P } else { P }
    | P % P | P # P | P $ P
    | while_t (B) {P} | while_s(B) {P} |
    while_st(B) {P}
    | gather(int) | scatter(int) | map(int,P) |
    reduce(int,P,P) | scan(int,P,P)
    
```

Fig. 5. The modified syntax of AGAPIA programs.

To be more appropriate to common programming languages some changes were done when writing AGAPIA code. “SI” from the syntax figure represents a simple interface declaration. Structures can be obtained by adding together more simple data types: (SI, SI). ( SI[] ) represents an array of simple data types. Instead of using sn/tn or sb/tb the decision was to merge them and use just int and bool for both temporal and spatial interfaces, but without losing the information of which category they are. Two new basic data types, “string” and “buffer” types were added for storing strings and sending buffers between distributed programs in an easy way.

“MI” is used for defining a module interface and it basically uses “SI” for this. From (or in) a module interface, the output (or input) can flow to one or more other modules. (SI;SI) represents two different processes while (SI;)\* is an array of processes. For example, if we are vertically composing a module M with a foreach\_s statement, then the south output interface of M should be something of type (SI;)\*. In basic AGAPIA programs users can use all type of C/C++ language constructs. At the high-level programs section, the language offers simple and high level composition and flow branching statements. The “for each” and patterns “gather”, “scatter”, “map”, “reduce”, “scan” were added in order to improve the expressiveness.

Because array of processes are something AGAPIA specific, some more details must be given. A simple array of structures (named A) of a pair containing an int and a bool is defined as A:(int, bool)[], while A[i] is used to access an index from this array. An array of processes (named V), with each process containing the same pair is defined as V:(int, bool;)\*, while V@[i] is used to access an index. The main difference is that elements from a simple array can’t be split to different AGAPIA programs just by composition, while the array of processes can. If there is a program which has as spatial input an array of processes and inside this program there is a composition like M # N # Z, each one accepting a simple pair of int and bool as spatial input, then the first three indices from

the array will go in the right order to M, N and Z. It is best to use array of processes when dealing with AGAPIA high level iterative statements ( for/each/while or patterns). In the case of the above example with M # N # Z then it suffices, and it is even clear, to have a spatial input like ( (bool,int) ; (bool, int) ; (bool, int)) – three process inputs, one for each program.

### C. High level statements

To change the input/output flow by conditional branching, we can use the “if” program. It has the following syntax: **if** (condition) {P\_IF } else { P\_ELSE } , where P\_IF and P\_ELSE are also two programs. There are two restrictions regarding these two programs: P\_IF and P\_ELSE programs should have the same interfaces (and even input interfaces with the same variable names) to make the input/output matching correctly. “condition” can only contain variables defined in the input interfaces of P\_IF and P\_ELSE. Fig. 6 shows how an “if” program looks like inside. Inputs received are buffered until condition can be evaluated.

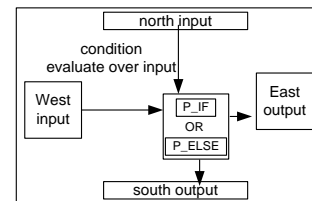

Fig. 6. Inside an if program in AGAPIA.

To create iterating compositions of programs, AGAPIA provides the following statements: for’s, fort, for\_st, foreach\_s, foreach\_t, foreach\_st, whiles, while\_t, while\_st. These are doing the same things as the “for” and “while” statements in the common programming languages, excepting that for each iteration an AGAPIA program is spawned and composed with other programs. Between consecutive iterations, the programs can be composed spatial, temporal and diagonal – as the usual programs composition. The type of the composition is indicated by the letters that comes after underscore in the statement name: “s” means spatial (#), “t” temporal (%), and “st” diagonal (\$). This rule is valid for all types of “for/each/\_” and “while\_” statements. As we can see from the syntax, these statements become AGAPIA programs too.

Fig. 7, 8, 9 shows how the for, foreach and while programs look internally for each iteration type. The figures are conclusive about how the input/output flows inside.

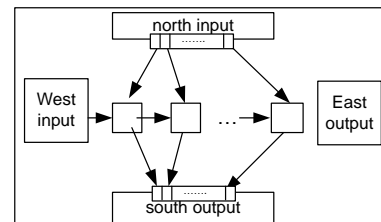

Fig. 7. Inside an for\_s/foreach\_s/while\_s program. There is a spatial composition between consecutive iterating programs.

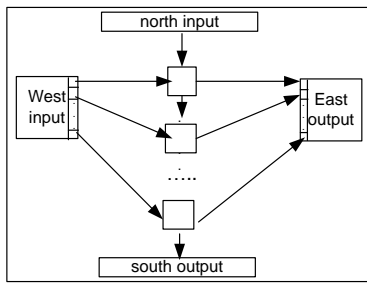

Fig. 8. Inside an `for/each_t` or `while_t` program. There is a temporal composition between consecutive iterating programs.

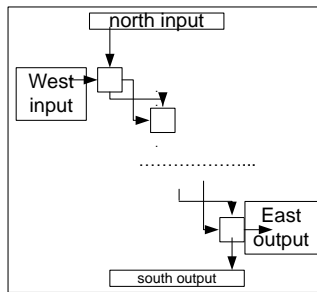

Fig. 9. Inside an `for_st/foreach_st` or `while_st` program. There is a diagonal composition between consecutive iterating programs.

As with the “if” program condition, the “while\_” program condition refers to the interface of the program it is iterating on. So if we have a program like `while_t(condition) {P}`, then condition can refer to the north and west input interfaces of P. If user knows the number of iterations then it is better in terms of performance to use the `for/for each` statements, because in background all internal instances could be created directly allowing the maximization of parallelism. There is one big difference between “for\_” and “for each\_”. “for\_” should be used when we want to impose a certain order on how the internal programs are instantiated. If we have a program like `foreach_s(n) {P}`, and n value does not depend on the input/output of P, and P doesn’t have any listen-speak dependency, then those n instances of type P could be spawned and executed in parallel in any order. If we use `for_s` instead, then the internal instances will be instantiated in the order of the iteration (although they could also run in parallel, if there is no listen-speak dependency between them).

Speaking in terms of interfaces, the iterating side of these programs has as interface an array of processes. If the interface of P is (west; north; east; south), then the `for_s / foreach_s/while_s` interface is (west, (north;)\*, east, (south;)\*).

Some clarifications must be made about how the parameters containing arrays of processes are sent between programs. If the program which sends input for an array of processes is an atomic program, then all data is sent in a chunk. Same thing happens if the receiver program is an atomic (we achieve this by buffering the inputs and detecting when all input expected arrived). If none of the modules are atomic, and both programs are connecting an (int;)\* to an (int;)\* then the mapping is made on the same indices, 1:1. If not, and for example the array of processes has type (int;)\*, then the input for this array of processes can contain in its specification just a single array of processes and this should be the last element. A

correct example is connecting (int;)\* to (int ; int ; .....;(int;)\*. Connecting (int; (int;)\*; int; ...) to (int;)\* is not allowed, because there is no mechanism to know how much the second item in the specification will expand. Considering these recursively, the compiler knows exactly the order of how elements come in the array. Also, for optimization purposes, if communicating programs are not atomic then we send array indices individually. Imagine a program which does some parallel computations and set individual items in an array of processes in the south interface. If this program is vertically composed with a `foreach_s` statement then sending array indices individually is a performance advantage. Each time an item is sent to the `foreach_s` program a new instance inside of it can start, maximizing this way the potential parallelism.

The other high level statements, which represents some ready to use common patterns, were created in order to improve the productivity in building complex applications. Scatter is used to transform from a simple array to an array of processes while Gather transforms an array of processes to a simple array. Common usage examples can include creating an array of tasks then splitting each item to a different program instance or receiving results from different programs in a simple array. The Map pattern can be used to apply an operation (represented by a given module) over a set of items and produce another set of items. Examples of usage include image processing, ray tracing or Monte Carlo sampling. AGAPIA also provides Scan and Reduce primitives which does the typical operations in logarithmic time over a set of inputs coming from different programs. Other kind of patterns such as pipeline or wavefront can be easily expressed just by using composition operators.

#### D. AGAPIA runtime, backend and how to use interface variables.

Paper [2] states in the „Conclusion and future work” section that we need an AGAPIA compiler. Because of this, the previous papers didn’t talk about how the programs are being executed or the input/output flow in detail. The compiler is now publicly available at <http://code.google.com/p/agapia-programming-language> and it is continuously updated. A briefly presentation is made here about how the programs execution works. All programs looks like a dataflow graph with nodes representing smaller programs. The communication between these nodes is transparent, composition operators or high-level statements and patterns automatically creates in background the links between input/output interfaces.

The source code for user written programs can be a mix of C/C++ and specific AGAPIA statements and operators. A program which doesn’t contain any specific AGAPIA composition or statements is called atomic. The semantic difference between the atomic programs and non-atomic ones is that the first category needs all the inputs available before starting to execute. The real computational tasks that can be executed in parallel by the internal schedulers are to be found in the atomic programs. To minimize the computational overhead, the atomic programs are translated and linked into C/C++ code. Only the non-atomic programs are being interpreted.

The scheduler is built on the top of MPI. The default scheduler's architecture is composed by a master and multiple workers. The master process responsibility is to coordinate input/output of the modules and detect new atomic modules that can be executed. These atomic programs are executed as soon as there is an idle worker available. Users can change this default execution by using some specifier near a module definition. Specifier "@Master" can make a module to be executed only on master – this is typically useful when there is a resource available just on the master. A module can be executed and coordinated by the same worker by specifying "@SameProcess" – this behavior can reduce the transfer time or allow the usage of small coordination modules with minimal overhead.

An important preparation for the next section is to show how we can use the variables defined in the interface of a program. The code below shows some examples of accessing input/output variables. We can access each one directly by its name. Usually we read from input interfaces, compute, then write in the output variables. Even if the below module has operator "@" used to access an array of processes, it still remains an atomic one and it is executed purely as C\C++ code. A parser included in the AGAPIA distribution translates in background the "@" operator into a series of C language calls.

```
Module TEST {listen arrayOfProcesses : (int;)* } { read nil }  
{  
// Read a value from index 0 in an array of processes  
value = arrayOfProcesses@[0];  
// Set a value to a simple array index  
chrs[0] = 'a';  
}{speak chrs: char[] } {write value : int }
```

### III. PARALLEL PATTERNS IN AGAPIA

This section presents some basic parallel programming patterns and how to implement them in AGAPIA. As Section 1 states, the patterns implemented here can be used in both shared and distributed memory models.

#### A. Fork-Join

The Fork-Join pattern lets control flow fork into multiple parallel flows that rejoin later [1]. It is the base of many patterns and its main usage is to split a process (parent) into two or more parts that could be computed in parallel. Below is an example of a simple implementation of this pattern in AGAPIA.

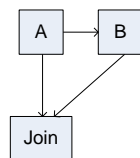

Fig. 10. Example of a Fork-Join. The process that execute program A spawns a new process that execute program B, continues execution in parallel, and after some time they join.

By simple composition of programs we can create a Fork-Join pattern in AGAPIA. Because of the read-write dependency, the program Join knows that it needs to get input

from both programs A and B to continue execution. Both programs can be executed in parallel and having the listen-speak dependency between A and B guarantees that A start before B. The easiness of the implementation comes from the fact that the user just needs to write the correct interfaces for programs and use the composition operators.

```
module ForkExample {listen nil}{read nil}  
{  
A#B  
%  
Join  
}{speak nil}{write nil}  
module A{listen nil}{read nil}  
{ .. code ..}  
{speakta:int}{write sa:int}  
module B{listen ta:int}{read nil}  
{ .. code ..}  
{speak nil}{write ba:int}  
module Join{listen nil}{read sa:int,sc:int}  
{ .. code ..}  
{speak nil}{write nil}
```

Creating a fork-join in MPI is possible by using the MPI\_Comm\_Spawn function. But there are some disadvantages over the AGAPIA solution. First thing is that user has to write different code/executable for the parent and child process. Then, communication between spawned child and joining is more complicated than in AGAPIA – user have to be carefully about calling MPI\_Wait and MPI\_Finalize in the right places and use the correct communication channel and id.

#### B. Map

The map pattern replicates a function over every element of an index set. The set can be abstract or associated with the elements of a collection [1]. Usually, it produces a new set of values, like in Fig. 11. Using this pattern user can write programs to solve problems like image processing, Monte Carlo sampling or ray tracing, in a parallel environment.

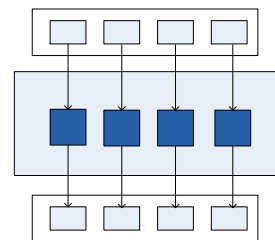

Fig. 11. Map pattern example. The input is a set of values, it applies the same function over all items in the set and usually obtain another set of values.

A Map can be defined by hand if complex situation needs. To exemplify this and show the background implementation of



a Map, an implementation in AGAPIA of this pattern is presented below. In this case the set is an array of processes of numeric values. A simple elemental function (the function being replicated) is used: multiply each number by two.

```
module MapExample{listen n : int }{read inputs:(int;)* }  
{  
  foreach_s(n)  
{  
  ElementalFunc  
}  
}{speak nil}{write outputs:(int;)*}  
module ElementalFunc{listen nil}{read in:int}  
{  
  out = in*2;  
}{speak nil}{write out:int}
```

The first n elements from “inputs” will get through the ElementalFunc, get multiplied by two, and then goes to the correct index in the “outputs” array. Because there is no listen-speak dependency, all ElementalFunc tasks can be executed in parallel. Compiler knows how to send the correct inputs from array to each ElementalFunc because, as Section 2 states, the elements in the “inputs” array will be available in the order the came in. Then, each input received will be sent to the correct iteration of the for each loop. If a needed input is not available yet in the array, the corresponding ElementalFunc instance will wait until it becomes available.

AGAPIA provides an existing implementation of this pattern that users can use to simplify a program implementation. Users have to define what the map operations does on the input element with the correct input and output types in the interface and to give as parameter the number of items the map should apply to. Map automatically adjusts depending on the type of composition and data types. An example of usage where the map is applied over the output of n modules of type A, then results are used as input for n modules of type B is given below:

```
foreach_s(n){A}  
%  
Map(ElementalFunc,n)  
%  
foreach_s(n){B}.
```

To implement this in MPI we first need to send the input to different processes (either calling a Scatter operation, or using parallel I/O which were processes read data on their own). Then, these processes compute the desired operation - the elemental function - and finally, a gather operation will be used to copy the results back to a root process. As Scatter and Gather operations are implemented, we need to create another communication channel to contain just the processes that

needs to run the elemental function. Also, for the two operations to complete, the root and workers should call them in the correct order. These disadvantages make this pattern implementation in MPI a slightly more error prone and harder to understand that it is by using AGAPIA which provides a clearer picture for users.

### C. Gather and Scatter

The Gather pattern reads values from a set of processes and stores them in a collection. The Scatter pattern is the inverse of the Gather pattern – the values from a collection are distributed to multiple processes. These are base operations for parallel programming with distributed memory and are also implemented in MPI: MPI\_Gather and MPI\_Scatter. Below are both operations implemented in AGAPIA.

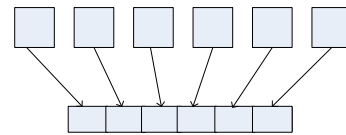

Fig. 12. Gather example.

```
module Gather{listen n : int }{read v:(int;)* }  
{  
  for (int i = 0; i < n; i++)  
    out[i] = v@[i];  
}{speak n : int}{write out : int[]}
```

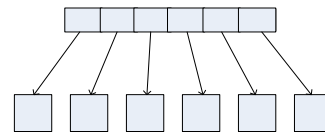

Fig. 13. Scatter example.

```
module Scatter{listen n : int }{read in: int[] }  
{  
  for (int i = 0; i < n; i++)  
    v@[i] = in[i];  
}{speak n : int}{write v:(int;)* }
```

Both patterns implementations are using the temporal interface for transmitting the number of items in the arrays. User could also choose to transmit the number of items through the spatial interface, but then he needs some identity operators to match correctly the interfaces. Examples can be found in [2] and [3].

AGAPIA already provides implementations for Gather and Scatter. A parameter representing how many items should be gathered/scattered must be given. An example to gather the results from a foreach\_s statement in an array is: foreach\_s(n) {A} % gather(n). This will gather the outputs from the south interface of all n modules of type A in a simple array. gather/scatter automatically define and checks the input/output interfaces depending on the source/destination of data.

### D. Pipeline

The pipeline pattern is usefully when the computation involves performing a calculation on many sets of data and

this calculation can be viewed in terms of data flowing through a sequence of stages. It is common in the implementation of real time applications, signal processing, online applications, compilers or systolic algorithms. There are two types of pipelines: linear pipelines – all stages that are applied over an input are executed serially, non-linear pipelines – can contain stages that could execute in parallel. Both types can be easily implemented in AGAPIA. Below is presented an implementation of a linear pipeline.

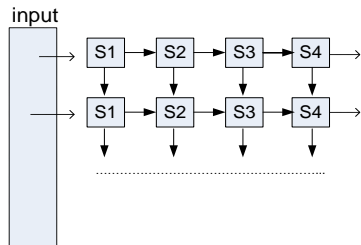

Fig. 14. Linear pipeline. There are read-write dependencies between levels, and listen-speak dependencies for consecutive programs of a level.

```

module Pipeline {listen InImagesArray :(image;)*}{read nil}
{
  for_t (int i = 0; i < NrImages; i++)
  {
    S1 # S2 # S3 # S4
  }
}
{speak nil}{write OutImagesArray:(image;)*}

```

We can make sure that a certain stage program can't be executed in parallel on different levels by creating a write-read dependency. An example of this kind of behavior can be obtained for program S1 like this:

```

module S1 {listen img: image}{read check:int}
{
  .. code to compute the imgout..
}
{speak imgout:image}{write check:int}

```

We can even play with groups of dependencies between stages on the same level. It's all about how the user put dependencies between programs. Non-linear pipelines can be easily obtained too:

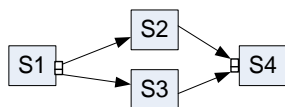

Fig. 15. Non-linear pipeline. S2 and S3 can be executed in parallel.

A program with a pipeline like in Fig. 15 can be implemented by changing the source code inside the for\_s statement from the previous pipeline implementation with: S1 # (S2%S3) #S4. By combining the pipelines with "if" statements, we can easily create some other kind of patterns like filters.

If we consider that a distributed system could run multiple non-linear pipelines in parallel then an implementation in MPI needs to use the dynamic process spawning or a custom scheduler created by user. The simplest way to do it, using dynamic process spawning, has some disadvantages. First, we need separate code files/executable for each component or group of components from pipeline that needs to be executed on different processes. This makes the code hard to follow, in contrast to AGAPIA where we have the entire code in one file, together with the entire pipeline flow. A second issue that appears often in pipeline applications is the diversity of parameters and data sent between components of the pipeline. In MPI we need several calls to MPI\_Send and MPI\_Recv functions. In AGAPIA the parameters are serialized and sent automatically according to programs interfaces.

### E. Geometric Decomposition

The Geometric Decomposition pattern breaks data into a set of subcollections. The purpose is to give this data to different processes for parallel execution. Sometimes, it is not necessary to transfer the data, like in the case of programming for a shared memory model. Stencil operations, which are used in image processing and simulations, are good examples of usage for this pattern.

Below is an example of an image filter skeleton implementation in AGAPIA which uses a shared memory model. The "Decomposition" program is responsible for breaking data – in our example it gives to each process, an equal number of consecutive lines from the input image. The number of tasks in which we want to break the computation of filter over the image is decided in this program by a call to an external function defined by user and transmitted through the temporal interface further. The "Task" program is the one responsible for executing the given part of the image.

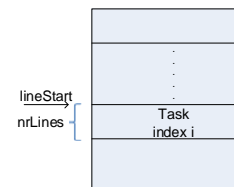

Fig. 16. Image decomposition.

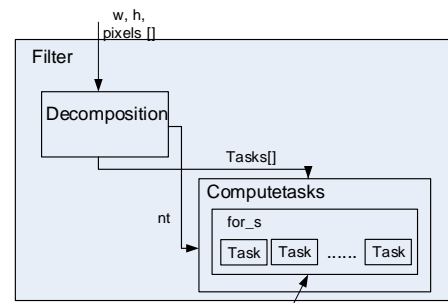

Fig. 17. The flow of input and execution in AGAPIA. The programs are represented by rectangles and their name is in the top-left corner.

```

Module Filter{listen nil}{read w:int, h:int, pixels:int[]}

```

```
{  
  Decomposition  
  $  
  ComputeTasks  
  }{speak nil}{write nil}  
  module Decomposition{listen nil}{read w:int, h:int,  
pixels:int[]}  
  {  
    nt = Utils::GetNbOfTasks(w,h);  
    for (int i = 0; i < nt; i++)  
    {  
      tasks@[i].lineStart = (h/nt) * i;  
      tasks@[i].nrLines = h/nt;  
    }  
  }{speak nt:int}{write tasks:(lineStart:int, nrLines:int);* }  
  module ComputeTasks{listen nt:int}  
  {read tasks:(lineStart:int, nrLines:int);* }  
  {  
    for_s (int i = 0; i < nt; i++)  
    {  
      Task  
    }  
  }{speak nil}{write nil}
```

If the user wants to solve this problem in the distributed case, then the only necessary change to the source code is to distribute the pixels data instead of line start and number of lines.

An implementation in MPI will make the code more complicated because we need to serialize the parameter and image buffer and then scatter data from master to workers. Also, user has to split code in two flows for master and workers, be carefully with indices and to call the MPI\_Scatter function on all processes that are doing tasks.

#### F. Reduction and Scan

A reduction combines every element in a collection into a single element using an associative combiner function [1]. Scan pattern computes all partial reductions in a collection.

These two patterns could be used for a broad category of applications, including numerical analysis (dot products and row-column products in matrix multiplication, convergence testing for linear equations, etc.) or image analysis. Because scan doesn't differ too much in the AGAPIA implementation than reduction, only the reduction operation is presented here. Below is a reduction operation with an associative combiner function, implemented in AGAPIA. The tree has a span of  $\log_2 N$ .

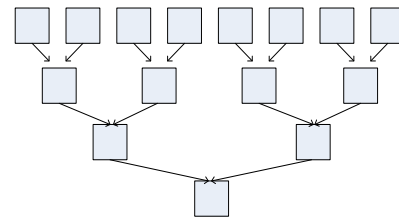

Fig. 18. Tree reduction pattern for an associative combiner function.

The program Reduce receives as input an array of processes each one having an integer value. Inside, it uses a program CombineFunc which receives as input two integers values and outputs a single one – the value resulted by combining the inputs. A simple example of combine function could be the addition of numbers.

```
module Reduce{listen nil}{read v:(int;)* }  
{  
  for_t (int i = 1; i <= log2 N; i++)  
  {  
    for_s(j = 1; j <= 2i; j++)  
    {  
      CombineFunc  
    }  
  }  
  ..... use the result here....  
}{speak nil}{write nil}  
  module ComputeFunc{ listen nil } { read a : int, b : int }  
  {  
    c = a + b;  
  }{speak nil} { write c : int }
```

In this case, the “for<sub>t</sub>” will spawn levels one by one, while the “for<sub>s</sub>”, will spawn all tasks needed for that level. All tasks on a level can be computed in parallel because there is no listen-speak dependency in the program “CombineFunc” (between tasks created at each level). On the other side, because of the read-write dependency, the computation respects the expected flow: the levels are guaranteed to be executed in the correct order.

Reduce and Scan patterns are already implemented in AGAPIA and can be reutilized by users in order to improve the development process and the clearness of the code. They receive three parameters: the number of elements to reduce/scan, a module defining the function to combine the elements and a module defining the neutral element of the combination (needed when the number of elements is not a power of 2 - In addition to the implementation shown above, if the number of elements is not a power of 2 then we use this neutral element to add fictive elements until we get a power of 2). For example the sum reduce presented above where the Source produces n items and Neutral produces a neutral element as output without receiving any input, can be defined

as: Source % Reduce(n, ComputeFunc, Neutral). Reduce will automatically adapt to the type of composition used and performs type checking for the input values, Neutral and ComputeFunc.

MPI has two functions that implement these two patterns: MPI\_Scan and MPI\_reduce. However it has some slightly disadvantages compared to AGAPIA. First, we need to create a separate communication channel for all processes implied in the process of scan/reduce, then, these functions acts like a barrier and needs to be called in the right order on all those processes. These things can make the code difficult to understand in comparison with AGAPIA code, where the pattern help the user to keep a code closer to the natural way of the solution formulation.

### G. Wavefront pattern

The Wave front pattern appears in programs with data elements laid out as multidimensional grids and which have data dependencies between elements that resemble a diagonal sweep. This is very common for dynamic programming problems or systolic algorithms. The temporal interface in AGAPIA makes the implementation of this pattern to be easy and clear.

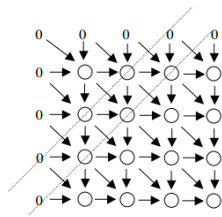

Fig. 19. Data dependencies for the longest-common-subsequence problem.

To implement this pattern in AGAPIA we need first to analyze the data dependencies and make sure that we can send all data needed by a program through its north and west interfaces. For example, the longest-common-subsequence problem has a diagonal dependency. If we consider that each cell (or group of cells) is a program instance responsible for computing the formula, then we need to transfer somehow that diagonal element from  $F(i-1,j-1)$  to  $F(i,j)$ . We can do this by sending first the item from  $F(i-1,j-1)$  to  $F(i-1,j)$  and then both data values from  $F(i-1,j)$  to  $F(i,j)$ .

In the distributed memory model we also need to distribute the characters of the two arrays A and B. Below is the main source code body (without initializations or data splitting). The “chA” and “chB” denotes the characters that each cell should compare when computing the value.

```
for_t(int i = 0; i < n; i++)
for_s(int j = 0; j < m; j++)
{
  ComputeCellValue
}
module ComputeCellValue{listen left:int, chA:int}
{read up:int, diag:int, chB:int}
{
  // F[i][j] = max(F[i-1][j-1]+1*(A[i] == B[j]),
  //             F[i][j-1], F[i-1,j]);
```

```
result = max( diag+1*(chA==chB), left, up);
}
```

```
{speak result:int,chA:int }{write result:int,result:int, chB:int}
```

To implement this in MPI we have to create a scheduler by hand to compute the cells that are ready for execution – which takes some important time to code - or to use dynamic process spawn in MPI - but this has the same disadvantages as the previous examples. Splitting the code/executable for different cells computation and communication issues will transform an implementation in MPI into something much different that the simple sequential implementation and how to user thinks about the solution generally. In AGAPIA, after a cell is computed it sends the output further making other programs ready for execution. These will be automatically scheduled in the backend and the user concerns are just to use the correct recursion and initialization as in a sequential program.

### IV. AN EXAMPLE COMBINING MULTIPLE PATTERNS AND PERFORMANCE EVALUATION

This section is dedicated to show a more complex example by using a combination of these patterns and to show how the AGAPIA implementation compares to the MPI one, in terms of performance, time of development and expressivity. The example used is composed from some of the patterns presented in the previous section: fork and join, scatter, gather, and a non-linear pipeline. The accent is put on the architecture of the application and how AGAPIA hides communication details and keeps a program modular and closer to how users thinks a solution. The low-level code of modules is not shown here due to space constraints, but it is the same code that we use in C/C++ language in order to implement those operations.

The problem discussed here is how to implement a distributed system which accepts two types of tasks from clients: text and image searching through some resources available on a predefined network address. These resources are books - for text searching - and images for image searching. We consider that each resource has an associated index. As a result, clients should receive back the index where the highest similarity occurred when comparing the user data to the network resource data.

The code given below begins with two definitions: the “userTask” type used to store data given to compare, the type and the client address (IP address considered as an integer). The MAIN module is the entry point of the application. It has as temporal input type an array of processes each of type “userTask”. The while\_t construct will create a SOLVE\_TASK module each time a new userTask is available in the temporal side. As the SOLVE\_TASK interfaces are defined, there is no dependency between consecutive iterations of the while\_t statement. Given this, multiple SOLVE\_TASK modules can run in parallel. Inside this module, there is a conditional statement which checks the type of the task. If it is a text request then it creates the SEARCH\_TEXT module, otherwise if it is an image then SEARCH\_IMG module it is created.

SEARCH\_TEXT and SEARCH\_IMG modules are similar in terms of structure, so only the code for the first one is shown here. This module receives a task from the parent

module (SOLVE\_TASK) in the temporal side. Inside of it, the first step is to create an array with N jobs description, in module CREATE\_ARRAY\_OF\_TASKS which splits the indices to search on for each task in equally parts. These jobs are scattered to the N modules instances that are created by the for\_s statement. After this step, jobs can be executed in parallel, the background scheduler assigning them to workers as soon as they get idle. After a module that performs the job finishes the execution on a worker, it will serialize the data declared in the module's output interface and send it back to master which coordinates the resulted data through the program's graph.

The REDUCE operations acts like a "join", waiting for all to complete then launch a classical max-reduce operation in order to find the index with the highest similarity. The results are then sent in the SEND\_RESULTS module which uses a parameter from local stack of the parent module.

```
struct userTask{ data : buffer, addr:int type : int }
#define N 16*4
module MAIN { listen tasks : (userTask;)* }{ read nil }
{
    while_t(true)
    {
        SOLVE_TASK
    }
} { speak nil } { write nil }
module SOLVE_TASK { listen task : userTask }
{
    if (task.type == TEXT)
    {
        SEARCH_TEXT
    }
    else if (task.type == IMAGE)
    {
        SEARCH_IMG
    }
} { speak nil } { write nil }
module SEARCH_TEXT { listen task : userTask }
{
    CREATE_ARRAY_OF_TASKS
}
%
SCATTER(N)
%
for_s (N) { TEXT_SIMILARITY }
%
```

REDUCE(N, MAXOP, NEUTRALOP)

```
%
SEND_RESULTS(task.addr)
} { speak nil } { write nil }
```

Module TEXT\_SIMILARITY is using a classical edit-distance implementation to compare the given text with each paragraph of the book. Images are compared inside module IMG\_SIMILARITY (similar in structure with TEXT\_SIMILARITY). The comparison is done using OpenCV library functions for comparing histograms. At any time, a user can change these two modules in order to implement other methods. The only requirement is to keep the same input/output interfaces demonstrating this way the modularity of the language.

In terms of development productivity and code size the AGAPIA implementation performs better than the corresponding MPI version because:

- The communication is transparent, the user doesn't need to write specific primitives for sending/receiving data
- By having the scheduler already implemented in the background there is no need to create a complicated scheduler by hand as the MPI implementation needs in order to compute the similarity jobs.
- Faster development time because a user can write the code closer to how he thinks the solution.
- Better modularity and less error prone than MPI. User can change at any time a module implementation just by keeping the correct interfaces. It is less error-prone because of the transparent communication model and modularity.

The cost of using AGAPIA in terms of performance is minor. Because the atomic module's code are compiled and linked directly as C/C++ code there is no performance difference when executing them. The only additional cost comes from the coordination. The coordination is internally optimized to avoid unnecessary data copies and it generally uses references when coordination happens on the same machine. At this point users must be carefully to avoid big data flow between modules if this is not needed. An example is the CREATE\_ARRAY\_OF\_TASKS which is atomic and this means it can be executed by any workers. This module does very little inside: it just sets indices and data for each job. Watching the global flow it makes no sense to execute this on workers. If we add @MASTER near the module declaration, and considering that SCATTER will also execute on master then we avoid copying a big data chunk representing a task to a worker just for splitting and setting some values.

Table 1 shows the compared result of executing a bunch of tasks generated at once on programs implemented in AGAPIA and MPI. The time to finish for all tasks and the additional memory footprint, excluding the memory used for storing task, is compared. Ideally we should get minimal performance and memory impact by using AGAPIA language.

TABLE I. COMPARATIVE RESULTS OF EXECUTION TIME AND MEMORY FOOTPRINT

Solution	Time to finish all tasks (seconds)	Memory footprint (excluding the memory used for storing tasks)
MPI	114.87	1756
AGAPIA	115.34	1911

The simulation was run using 64 processes on a local network and involving 8 different machines. Results show that the performance penalty of using AGAPIA implementation is small while the benefits given by productivity and modularity of the application are big enough to recommend its usage.

#### V. 7. CONCLUSION AND FUTURE WORK

This paper presented well-known parallel programming patterns and how they can be implemented in AGAPIA language. This is just a small subset of patterns that can be implemented in this language. By using and combining them and with the help of the transparent communication model that it provides, we can create highly structured parallel programs that are easy to write, modular and less error prone. All this advantages are given by language semantics, high level composition statements and its temporal interface. One of the future improvements for AGAPIA is to study the possibility of tasks cancelation and to improve the scheduling algorithm by adding priorities or GPU processing. An important point to focus on is to study in deep some categories of applications that can take advantage by using AGAPIA language.

#### REFERENCES

- [1] Michael McCool, James Reinders, Arch Robison, "Structured Parallel programming: Patterns for Efficient Computation", Morgan Kaufmann July 9, 1012.
- [2] Dragoi, C., Stefanescu, G.: "On compiling structured interactive programs with registers and voices"; Proc. SOFSEM 2008, LNCS 4910, Springer (2008), 259-270.
- [3] Alexandru Popa, Alexandru Sofronia, Gheorghe Stefanescu, "High-level Structured Interactive Programs with Registers and Voices"; Journal of Universal Computer Science, vol. 13, no 11 (2007) 1722-1754.
- [4] Timothy G. Mattson, Beverly A. Sanders, Berna L. Massingill, "Patterns for Parallel Programming", Addison-Wesley, September 25, 2004
- [5] James Reinders, "Intel Threading Building Blocks, Outfitting C++ for Multi-core Processor parallelism"
- [6] Mordechai (Moti) Ben-Ari, "Principles of Concurrent and Distributed Programming, Second edition", Addison-Wesley, 2006.
- [7] Alfred V. Aho, Ravi Sethi, Jeffrey D. Ullman, "Compilers, Principles, Techniques, and Tools, Columbia University, January 1, 1986.
- [8] Dragoi, C., Stefanescu, G.: "Structured programming for interactive rv-systems"; Institute of Mathematics of the Romanian Academy, Preprint 9/2006, Bucharest (2006)
- [9] Agha, G.: "Actors: A model of concurrent computation in distributed systems"; MIT Press (1986).
- [10] W. Wadge and E.A. Ashcroft. Lucid, the data flow programming language. Academic Press, 1985.
- [11] Hong Lin, Jeremy Kemp, Padraic Gilbert, "Computing Gamma Calculus on Computer Cluster", International Journal of Technology Diffusion, Volume 1, Issue 4, 2010.
- [12] Donald, S. and Le Vie, Jr. (2000). Understanding Data Flow Diagram. Proceedings of the 47th annual conference on Society for Technical Communication. Texas: Integrated Concepts, Inc.



# Interventional Spasticity Management for Enhancing Patient – Physician Communications

## Improving Outcomes for Stroke Patients

Chiyuri NAGAYAMA

Department of Life Sciences  
Graduate School of Ochanomizu University  
Tokyo, Japan

**Abstract**—Stroke is the third most common cause of death in the Western world, behind heart disease and cancer, and accounts for over half of all neurologic admissions to community hospitals. Spasticity is commonly defined as excessive motor activity characterized by a velocity-dependent increase in tonic stretch reflexes. It is often associated with exaggerated tendon jerks, and is often accompanied by abnormal cutaneous and autonomic reflexes, muscle weakness, lack of dexterity, fatigability, and co-contraction of agonist and antagonist muscles. It is a common complication of central nervous system disorders, including stroke, traumatic brain injury, cerebral palsy, multiple sclerosis, anoxic brain injury, spinal cord injury, primary lateral sclerosis, and hereditary spastic hemiparesis. Leg muscle activation during locomotion is produced by spinal neuronal circuits within the spinal cord, the spinal pattern generator [central pattern generator (CPG)]. For the control of human locomotion, afferent information from a variety of sources within the visual, vestibular, and proprioceptive systems is utilized by the CPGs. Findings of this research can be applied to older adults in longitudinal home care who suffer spasticity caused by stroke.

**Keywords**—*Electromyography; Spasticity; Internal Modeling; Viscoelasticity; Stroke Rehabilitation*

### I. INTRODUCTION

#### A. Stroke Rehabilitation

Stroke is the third most common cause of death in the Western world, behind heart disease and cancer, and accounts for over half of all neurologic admissions to community hospitals in Fig. 1. It is a common pre-cursor to placement in nursing homes or extended care facilities. Seven-hundred thousand new or recurrent cases of stroke are reported annually, and there are nearly 5.4 million stroke survivors currently in the USA. The estimated cost of care and lost income due to stroke in 2005 totaled \$56.8 billion, of which costs due to lost income equaled \$21.8 billion.

Comprehensive rehabilitation may improve the functional abilities of the stroke survivor, regardless of age and neurologic deficits, and may decrease long-term patient care costs [1]. Approximately 80% of stroke victims may benefit from inpatient or outpatient stroke rehabilitation. Ten percent of patients achieve complete spontaneous recovery within 8–12 weeks, while 10% of patients receive no benefit from any treatment. The literature suggests that intensive post stroke rehabilitation significantly improves functional outcomes. One meta-analysis of nine trials involving organized inpatient

multi-disciplinary rehabilitation demonstrated significant reductions in death, death or institutionalization, and death or dependency. For every 100 patients receiving organized inpatient multi-disciplinary rehabilitation, an additional five returned home independently. Patients who were assigned to a specialized stroke service that included rehabilitation services had significantly greater survival rates at 1 year poststroke, better quality of life 5 years poststroke, and greater probability of surviving and living at home at 10 years poststroke. Stroke survivors admitted to inpatient rehabilitation facilities were more likely to return home than those admitted to traditional nursing homes, despite the higher costs. There is an association between the compliance with stroke guidelines and patient satisfaction, even after controlling for functional outcomes. While a small but statistically significant intensity-effect relationship exists between rehabilitation and functional outcomes, larger, more comprehensive studies are still needed to determine what aspects of the rehabilitation are effective and why rehabilitation works (Fig. 2).

Motor recovery usually occurs in well-described patterns after stroke. Within 48 h of loss of movement, muscle stretch reflexes become more active on the involved upper and lower extremities in a distal-to-proximal direction. Onset of spasticity ensues thereafter, resulting in resting postures known as synergy patterns. Volitional movement returns in the same patterns, but eventually progresses to isolated movement. Spasticity decreases with increased volitional movement, but muscle stretch reflexes always remain increased despite total recovery [2]. Poor prognostic indicators for motor recovery include: proprioceptive facilitation (tapping) response greater than 9 days; prolonged flaccid period; onset of motion greater than 2–4 weeks; absence of voluntary hand movement greater than 4–6 weeks; and severe proximal spasticity.

Motor recovery occurs despite the presence of brain damage due to the unmasking of neural pathways and synapses not normally used for a given function that can be called upon to process the remaining input and ultimately replace the damaged system [3]. First described in the 1980s, researchers are gaining an understanding of the physiologic mechanisms of motor recovery after stroke. Positron emission tomography (PET) and functional magnetic resonance imaging (fMRI) have been helpful in identifying plasticity changes in association with improvements in motor function. The fMRI has demonstrated extended activation in the sensorimotor



cortex, premotor and dorsolateral prefrontal cortex, and around the perimeter of the infarcted area during rehabilitation interventions [4].

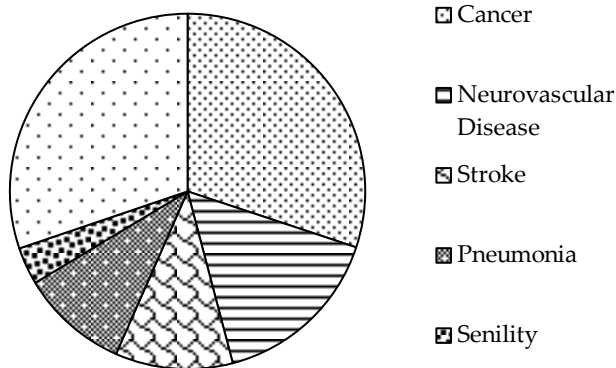

Fig. 1. Most Common Disease in Japan



Fig. 2. Passive Motion of Ankle Joint based on Daily Rehabilitation

### B. Stroke with Cerebral Palsy

Cerebral palsy (CP) is the most common physical or motor disability affecting children in developed countries, the prevalence being 2.0–2.5 per 1000 live births. The prevalence has remained constant for decades, with improvements since the 1990s in live birth rates and the increased incidence of very pre-term births. Despite being a common and important clinical problem, there is still lack of precision in the definition of CP or as some prefer “the cerebral palsies”. While the definition of CP has been refined from time to time, there appears to be a general agreement that the condition is characterized by “aberrant control of movement or posture appearing in early life, secondary to central nervous system lesion, damage, or dysfunction and not the result of a recognized progressive or degenerative brain disease”.

Children with spasticity should be managed in a multi-disciplinary context, and a goal-oriented approach adopted based on clinical findings and the expectations and desires of the family and child. Careful selection of intervention methods for any muscle tone problem is very important. Some children with CP may depend on, and benefit from, primitive reflex patterns and increased muscle tone for weight bearing, transfers, and ambulation. However, in many other children eliminating spasticity enables them to be more functional. Treatment can also be classified as temporary (reversible) or permanent (irreversible) and as focal or generalized. Assessment of gait patterns is critical to help determine

spasticity management, and physical therapy. Gait patterns can really only be precisely identified and categorized by three-dimensional (3D) gait motion analysis, but two-dimensional (2D) video recording with slow motion replay can also greatly enhance routine clinical observation.

### C. Spasticity Management

Spasticity is commonly defined as excessive motor activity characterized by a velocity-dependent increase in tonic stretch reflexes. It is often associated with exaggerated tendon jerks, and is often accompanied by abnormal cutaneous and autonomic reflexes, muscle weakness, lack of dexterity, fatigability, and co-contraction of agonist and antagonist muscles. It is a common complication of central nervous system disorders, including stroke, traumatic brain injury, cerebral palsy, multiple sclerosis, anoxic brain injury, spinal cord injury, primary lateral sclerosis, and hereditary spastic hemiparesis. In many individuals, the presence of spasticity has negative consequences, interfering with mobility and activities of daily living. Disability may result from spasticity-related impairment of posture, abnormal quality of movement, painful spasms, and poor hygiene. In these patients treatment of spasticity is often considered (TABLE 1).

Muscle tone, defined as the resistance to externally imposed muscle movement, is modulated by central nervous system influences on the alpha motor neurons in the spinal cord. The pathways that regulate tone are similar to those that regulate voluntary and involuntary motor movements and, as a final common pathway, involve the spinal reflex arc. Alpha motor neurons that innervate muscle fibers are located in the ventral horns of the spinal cord, and comprise the efferent limb of this reflex arc. Afferent sensory impulses from muscle spindles are relayed to the spinal cord. Some of these fibers synapse directly on alpha motor neurons that innervate agonist muscles. This is a monosynaptic reflex pathway and allows for sensory feedback necessary for motor movements. There are several descending central nervous system pathways that synapse directly or indirectly on motor neurons and allow for the control of movement. Upper motor neuron lesions result in spasticity from a number of mechanisms. Collateral branches from these descending motor pathways excite inhibitory presynaptic interneurons. With an upper motor neuron lesion this excitation is removed leading to decreased “presynaptic inhibition” of the motor neuron pool and over-activity of the spinal reflex pathways.

Unfortunately, spinal injury is an increasingly common condition in Western societies, affecting over 100,000 citizens in the European Community. The pattern of incidence is largely due to accidental injury often in road traffic accidents and also reflects the relatively long life expectancy of these patients, which now approaches that of uninjured members of the community [5]. The spinal injury has many consequences such as loss of voluntary movement and sensation, muscle wasting, and urinary problems but the residual involuntary muscle tone and movements known as spasticity is the principle concern. Spastic contractions may be long lasting and lead to skeletal deformity or they may be brief and intense jerks of the limbs, which disturb sleep or make other activities, such as transfer from a bed to a wheel-chair difficult.

Spasticity is a major concern for those interested in rehabilitation of the spinal cord [6]. This is particularly true for those interested in reconstructing movements by electrical stimulation strategies, given that any programmed movement may be destroyed by an unexpected spasm. In addition, there is a fear that stimulation strategies may make spasticity worse. In general, physiotherapists, clinicians, and researchers believe that the frequency of spasms can be reduced following muscle training, but that the intensity of spasms may be greater. The increased force could be due to the same neural activity generating more force from the strengthened muscle. In addition, there were repeated comments from patients that their spasms were less troublesome, particularly during the night, resulting in their sleep being less disturbed. Whilst these statements were supported by patient diaries it was impossible to make any definitive statement about spasms and training. We hoped the repeated testing would answer this question but the results of the tests employed showed very little agreement and we conclude that there is still no single definitive measurement, which can define the intensity of muscle spasm.

TABLE I. BIOMEDICAL EVALUATION OF SPASTICITY CAUSED BY STROKE

Ashworth Scale	Grade	Degree of Muscle Tone
	1	No increase in tone
	2	Slight increase in tone
	3	More marked increase in tone
	4	Considerable increase in tone
	5	Affected part rigid in flexion or extension

## II. EXPERIMENTAL SECTION

### A. Passive Motion Device for EMG Measurement

One of the fundamental principles of electromyography (EMG) is the assessment of the peripheral nervous system's ability to conduct an electrical impulse. Nerve conduction studies and needle EMG are commonly referred to as EMG studies. Electromyography plays a crucial role in identifying disorders that affect the peripheral nerve, the dorsal root ganglia, the nerve root, or the anterior horn cell. Electromyography can also identify disturbances at the level of the neuromuscular junction and in the muscle. In addition, EMG studies can provide useful information in disorders involving the upper motor neurons or disorders of volition as well as evaluating gait. Thus, EMG serves as an important diagnostic and prognostic tool when applied within the context of the clinical neurologic examination. A detailed, focused history and neurologic examination should serve as the template upon which one designs and performs an EMG study. Data acquired during an EMG study must always be interpreted within the clinical context because the same data may have very different interpretations depending on the clinical situation. An EMG study performed in isolation of the clinical context may provide little useful information.

The primary goals of an EMG study are to localize the lesion, characterize the underlying nerve pathophysiology, quantitate the severity of the lesion, and assess the temporal course of the disorder. Localizing a lesion within the peripheral nervous system is best achieved with the use of an

EMG study. An EMG study can be tailored in such a fashion as to specifically localize the lesion to the nerve roots, plexus, trunks, or individual peripheral nerves. A clinician designing an EMG study must have intimate knowledge of the anatomy of the peripheral nervous system for precise lesion localization. EMG studies can often identify the underlying pathologic process involving a nerve lesion, and can determine whether the pathology leading to the clinical deficit is secondary to axonal loss, demyelination, or if the underlying disorder is secondary to muscle disease or neuromuscular dysfunction. This differentiation between pathologic processes allows for a narrowing of the differential diagnosis. An EMG study can also assess the degree or extent of axonal loss versus demyelination, which then allows a clinician to predict the extent of recovery from a particular lesion and the expected time frame in which this recovery should take place. A lesion that primarily involves axonal loss will carry a worse prognosis, and therefore a less complete recovery would be expected. A lesion that is a result of demyelination can be expected to recover fully when given the required time for remyelination. Lesions with mixed pathology will recover in an intermediate time frame. An EMG study can provide data on the temporal course and rate of recovery of a lesion. Abnormalities observed on EMG can separate lesions into acute or chronic. EMG must therefore take into account the patient's clinical time course for accurate interpretation of the abnormalities observed during the study.

### B. Further Studies of Prosthetics with Stretch Reflex

BCI is a communication and control system that does not depend in any way on the brain's normal neuromuscular output channels [7]. Such a system involves an input stimulus such as a tactile stimulus. The user's intent is conveyed by brain signals (such as EEG) rather than by peripheral nerves and muscles, and these brain signals do not depend on neuromuscular activity for their generation.

Furthermore, as a communication and control system, BCI establishes a real-time interaction between the user and the outside world. The user receives feedback reflecting the outcome of the BCI's operation, and that feedback can affect the user's subsequent intent and its expression as brain signals. For example, if a person uses BCI to control the movements of a robotic arm, the arm's position after each movement is likely to affect the person's intent for the next movement and the brain signals that convey that intent. Thus, a system that simply records and analyzes brain signals, without providing the results of that analysis to the user in an online interactive fashion is not BCI.

Much popular speculation and some scientific endeavors have been based on the fallacious assumption that BCI is essentially a "wire-tapping" or "mind-reading" technology, a device for listening in on the brain, for detecting its intent, and then accomplishing that intent directly rather than through muscles. This misconception ignores the central feature of the brain's interactions with the external world: that the motor behaviors that achieve a person's intent, whether it be to walk in a certain direction, speak certain words, or play a certain piece on the piano, are acquired and maintained by initial and continuing *adaptive changes* in the central nervous system

(CNS) function. During early development and throughout later life, CNS neurons and synapses continually change both to acquire new behaviors and to maintain those already acquired. Such CNS plasticity underlies acquisition of standard skills such as locomotion and speech and more specialized skills as well, and it responds to and is guided by the results achieved. For example, as muscle strength, limb length, and body weight change with growth and aging, CNS adjusts its outputs so as to maintain and desired results.

TABLE II. UBIQUITOUS MONITORING BASED ON PROSTHETICS

	Example
<b>Application of Human Numerical Modeling</b>	Control Kitchen Tools
	Control Air Condition
	Control Robot
	Speaking with Child
	Control Wheelchair
	Communication

TABLE III. DEVELOPMENT OF A BIPEDAL ROBOT WITH NEUROPLASTICITY

	Example
<b>Applications of Human Numerical Modeling</b>	Help for Robot Walking
	Help for Robot Cooking
	Help for Robot Typing
	Help for Robot Dressing
	Help for Robot Eating
	Help for Robot Buying

This dependence on initial and continuing CNS adaptation is present whether the person's intent is accomplished in the normal fashion, i.e., through peripheral nerves and muscles, or through an artificial interface, BCI, which uses brain signals rather than nerves and muscles. BCI use depends on the interaction of two adaptive controllers: the user, who must generate brain signals that encode intent; and the BCI system, which must translate these signals into commands that accomplish the user's intent. Thus, BCI use is a skill that both user and system must acquire and maintain. The user must encode intent in signal features that the BCI system can measure; and the BCI system must measure these features and translate them into device commands. This dependence, both initially and continually, on the adaptation of a user to a system and a system to a user is the fundamental principle of BCI operation, and its effective management is the principal challenge of BCI research and development, shown in Table 2 and Table 3.

### III. RESULTS AND DISCUSSION

#### A. EMG Activity Measurement

Difficulty in walking is reported by 10% of Americans. One-third report major difficulty. They are unable to walk or climb stairs or stand. The most rapid rates of increase occur after ages 54 and 74 years old.

Musculoskeletal and joint diseases account for 24% of cases of major difficulty, back pain for 8%, stroke for 5%, and multiple sclerosis for 2%. Falls affect 41% of these people

yearly. Eleven percent never leave their home and only 32% get out of their home daily. By report, 25% receive some physical therapy during the year of major difficulty walking. At this level of difficulty, 48% with stroke use a cane, 28% use a walker, and 44% a wheelchair. Six months after a traumatic spinal cord injury (SCI), 2% of subjects graded by the American Spinal Injury Association (ASIA) scale as ASIA A (sensorimotor complete) are able to walk at least 25 feet 24 h after onset: this percentage is 30% for those graded ASIA B (motor complete), and 94% for those graded ASIA C.

Six months after stroke, 85% of patients with a pure motor impairment, 75% with sensorimotor loss, and 35% with sensorimotor deficits will recover the ability to walk at least 150 feet without physical assistance. These levels of recovery do not necessarily lead to the patient walking well enough to navigate outside of their home. Only 40% of patients who recover walking ability after stroke achieve community-walking velocities. More functional walking may also reduce risk factors for cardiovascular disease, recurrent stroke, and frailty by permitting more opportunity for exercise and fitness. The rehabilitation of walking poses some common questions about the services provided by clinicians [8]. How do we know when our patients have received enough goal-directed therapy for their level of motor control? What measures should we use to rate progress?

The study of movement control has relevance to our understanding of the brain and spinal cord function. However, it also has implications for various fields, such as neurology, cognitive neuroscience, rehabilitation medicine, and robotics. The understanding of movement disorders and their appropriate treatment critically depends on the knowledge of the neuronal mechanisms underlying functional movements. The study of movement disorders is a rapidly expanding field in medicine, leading to increasing costs for treatment and rehabilitation [9].

Locomotion is subconsciously performed everyday with high reproducibility. It is automatically adapted to the actual conditions, such as ground irregularities with a large security range. Changed locomotive characteristics are frequently the first sign of a central or peripheral lesion of the motor system. Neurological examination in such cases is characterized by changes in reflex excitability and muscle tone and leads to an appropriate diagnosis underlying the gait disorder. The physical signs obtained during the clinical examination can, however, give little information about the pathophysiology underlying the movement disorder: stretch reflex excitability and muscle tone are basically different in the passive (clinical examination) compared with an active motor condition (movement).

In addition, during a movement such as gait, several reflex systems are involved in its execution and control. Therefore, for adequate treatment of a movement disorder, we have to know about the function of reflexes in the respective motor task. A movement such as locomotion is determined by the stretch of EMG activation of antagonistic leg muscles as well as intrinsic and passive muscle properties.

The EMG activity recorded from the leg muscles (Fig. 3, Fig. 4, Fig. 5, and Fig. 6) reflects the action and interaction

between central programs and afferent inputs from various sources, which can only be separated to a limited degree [10]. For an assessment of the neuronal control of locomotion we have to record the EMG activity from several antagonistic leg muscles and the resulting biomechanical parameters such as joint movements and, eventually, of muscle tension. Using such an approach, it is possible to evaluate the behavior of neuronal and biomechanical parameters during a gait disorder. Any changes in the neuronal or biomechanical systems may lead to movement disorder.

Furthermore, impaired movement is not only the consequence of a defective central proprioception. Rather, the movement disorder also reflects secondary compensatory processes induced by the primary lesion. In many cases, the altered motor response can be considered as an optimal outcome for a given lesion of the motor system. The complexity of primary and secondary effects of a lesion requires a detailed analysis of the movement disorder to determine the target of any treatment.

Leg muscle activation during locomotion is produced by spinal neuronal circuits within the spinal cord, the spinal pattern generator [central pattern generator (CPG)]. For the control of human locomotion, afferent information from a variety of sources within the visual, vestibular, and proprioceptive systems is utilized by the CPGs. The convergence of spinal reflex pathways and descending pathways on common spinal interneurons appear to play an integrative role. The generation of an appropriate locomotive pattern depends on a combination of central programming and afferent inputs as well as the instruction for a respective motor condition.

This information determines the mode of organization of muscle synergies, which are designed to meet multiple conditions of stance and gait. Central mechanisms and afferent inputs interact in such a way that the strength of a reflex in a muscle or synergistic group of muscles is dependent on the actual task. The actual weighing of proprioceptive, vestibular, and visual inputs to the equilibrium control is context-dependent and can profoundly modify the central programming. Through this weighting, inappropriate responses are largely eliminated. Any evaluation of reflex function has to be assessed in connection with the actual motor programming, the biomechanical events (shown in Fig. 7), including their needs and their restraints.

Originality of this work is that measured spasticity of hemiparesis patients in stroke is different between spastic side and healthy side of soleus muscle. And in this work will further reveal the fact of internal modeling mechanism which is error function between spastic side and healthy side. We developed comparison between weak people and strong people are important for higher level education. So, we insist communication between patients with mental stress and people with skill of information technology enhance better learning in school.

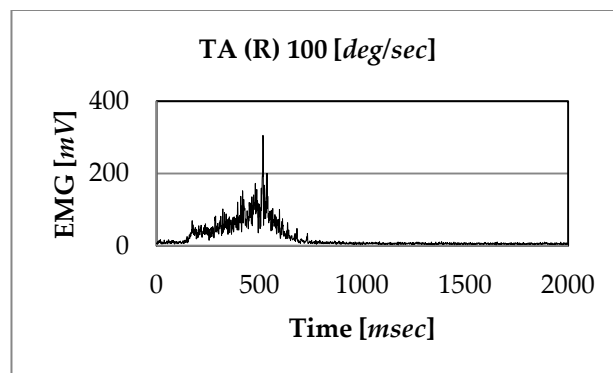

Fig. 3. EMG of the Tibialis Anterior Muscle of Spastic Limb

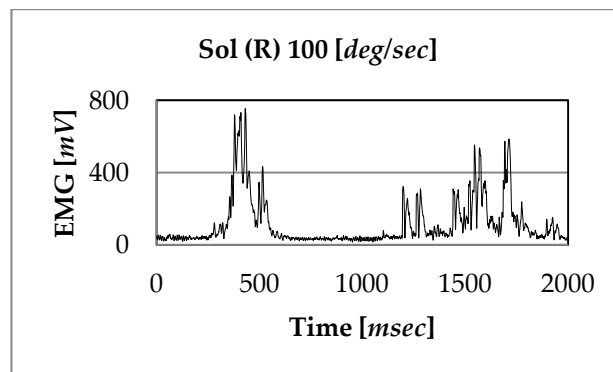

Fig. 4. EMG of the Soleus Muscle of Spastic Limb

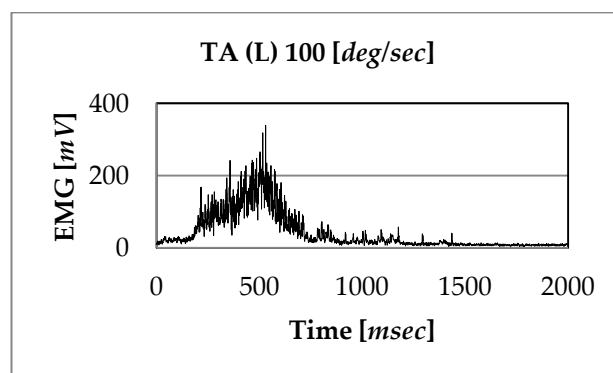

Fig. 5. EMG of the Tibialis Anterior Muscle of Healthy Limb

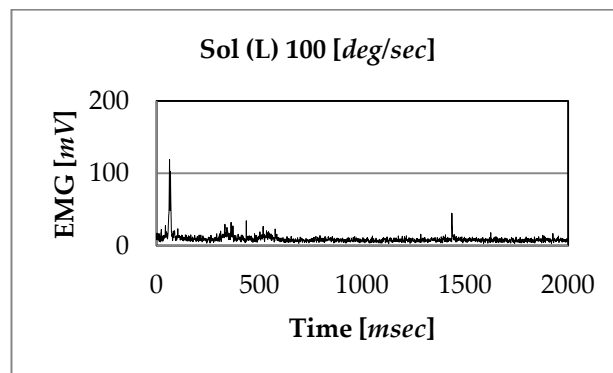

Fig. 6. EMG of the Soleus Muscle of Healthy Limb

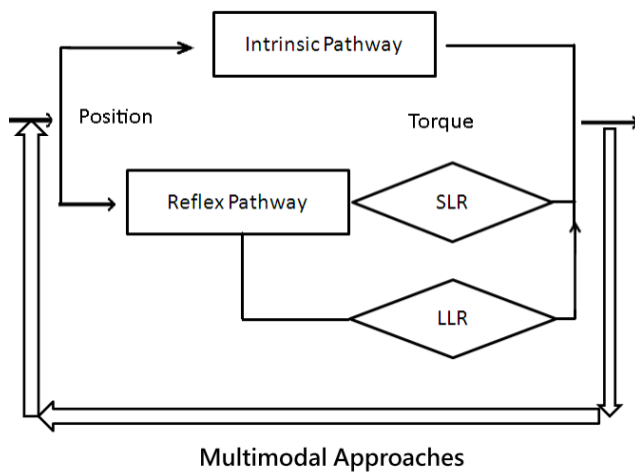

Fig. 7. Viscoelastic Properties of Spasticity for Motor Control System

### B. Multimodal Approaches for Applications

It is known that the blind do experience mental imagery, although in the congenitally blind this cannot be visually based. In cases of acquired blindness, the ability to image visually decays over time [11]. A classic mental imagery task, originally introduced visually decays over time. A classic mental imagery task, originally introduced using visually presented stimuli, involves mental rotation. Blindness, particularly when congenital, shows performance of tasks requiring mental rotation of haptic stimuli. This suggests that visual imagery can facilitate haptic perception. ERP studies have shown that slow negativities recorded over the parietal scalp during mental rotation of haptic stimuli extend posteriorly over occipital areas in the blind. Similarly, relatively greater occipital negativity was observed in the blind than the sighted during mental imagery of textures felt with the fingertips. While the precise areas involved could not be localized, these studies indicate that the blind recruit their visual cortices for mental imagery in addition to the language functions discussed earlier. More recent PET studies show that early blind and sighted people activate rather similar areas during mental imagery.

Over the last few years, numerous investigations have revealed that visual cortical areas are active during tactile tasks even in sighted people. Although the tasks used in these studies differed from those employed to study the blind, and the precise nature of visual cortical processing in the blind and sighted remains to be elucidated, the findings raise the possibility that visual deprivation simply amplifies the normal range of cross-modal recruitment. The first report that visual cortical areas are active during tactile perception was based on a PET study. A contrast between an orientation discrimination task and a control task requiring discrimination of grating groove width yielded activation focused in the visual cortex. Others have shown that this focus was active during visual discrimination of spatial mental imagery of the grating. To rule out the possibility that cortical activation was merely an epiphenomenon, transcranial magnetic stimulation (TMS) was used to test whether blocking processing at this focus disrupts tactile perception. TMS applied directly over the locus of PET activation and at sites close to it (but not at more distant sites)

significantly impaired performance in the grating orientation task.

These changes in performance and somatosensory cortex and visual deprivation are paralleled by both electrophysiology and autoradiography. An early indication of cross-modal plasticity in blind humans was provided by a report that used PET scanning to show that occipital cortical areas, generally considered to be visual in function, were more metabolically active in early blind individuals than in the late blind or sighted. This was interpreted as evidence of greater synaptic activity in the early blind, possibly reflecting incomplete developmental pruning of synapses. Subsequently, event-related potentials (ERPs) and MEG recordings were used to demonstrate occipital cortical recruitment in the blind during auditory discrimination of tones. However, because occipital activity was evoked in another ERP study during both tactile discrimination of line orientation and auditory tone discrimination, it has been suggested that this is the result of nonspecific attentional effects. Occipital cortical activity in the blind also occurs during sound localization, as first shown in ERP.

Considerable excitement has been generated by the observations that visual cortical regions of blind subjects are involved in reading Braille. One line of evidence for this comes from activation of neuroimaging studies. In interpreting these functional imaging studies, it is important to note that the underlying experimental design relies on measurement of a difference in the local hemodynamic response between an experimental condition of interest and a control condition. That the observed effects were due to finer movement was excluded by fMRI study of Braille character discrimination using stimulus presentations to the passive finger.

Activation of medial occipital cortex by Braille reading (relative to rest) occurs in early blind subjects, whereas these regions are deactivated in the late blind and sighted. A complementary approach to functional neuroimaging is provided by the technique of TMS. While the former method reveals brain areas that are active during a task, the latter can be used to transiently disrupt the function of a local cortical zone. If this interferes with performance of the task, it can be inferred that the cortical focus carries out processing that is necessary for the task. TMS over the medial occipital cortex impaired the ability of blind subjects to identify Braille or Roman letters and also distorted their subjective percepts of the stimuli. These effects (for Roman letters) were absent in sighted subjects, who were more susceptible than their blind counterparts to TMS over the sensorimotor cortex contralateral to the hand used. Thus, visual cortex is actually functionally involved in Braille reading.

This conclusion from the use of TMS is corroborated by the study of an early blind person who, after an infarct of the bilateral occipital cortex, developed alexia for Braille with otherwise normal somatosensory perception. Inactivation by TMS of the medial occipital cortex disrupted Braille-reading performance in the early blind but not late blind, implying that visual cortical involvement in Braille reading depends on cross-modal plasticity (shown in Fig. 8) that takes place during the critical period of visual development.

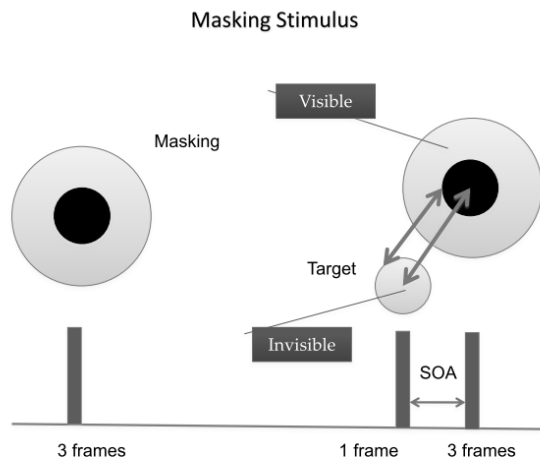

Fig. 8. Universal Design based on Internal Modeling of the Cerebellum

We have an idea about our practice that neighborhood walkability with visual light input (result of microwave). If people have impairments, we think they should go out and do daily works for their behavioral performance improvement. This functional recovery is also possible by wearable device such as Fig. 8. This kind of wearable device could be used in iPhone or PDA (smart phone) device.

#### IV. CONCLUSIONS

The individual computational elements of the nervous system—neurons—are physically small in diameter, allowing them to be packed together into dense nerve tracts and nuclei. To achieve biomimetic function, it is desirable to exchange information with neurons on a similar spatial scale. Microelectronic technology is just starting to work comfortably at the micron scale, but it remains difficult to engineer interfaces between electronic and biological structures with such small dimensions. Given, as yet, limited technology at our disposal, it has become necessary to look for situations in which relatively crude interfaces happen to

produce clinically useful effects. In general, these consist of pathologies in which neural function is altered rather than absent; neural prosthetic treatment then consists of crudely modulating the residual activity to achieve a net benefit. This research should be applied for older adults in longitudinal home care who have spasticity caused by stroke. Author expects for readers that this study will practice in smart community project in Japan.

#### REFERENCES

- [1] M. Gose, S. Plachta-Danielzik, B. Willié, M. Johannsen, B. Landsberg, and M. J. Müller, "Longitudinal influences of neighbourhood built and social environment on children's weight status," *Int. J. Environ. Res. Public Health*, vol. 10, pp. 5083–5096, October 2013.
- [2] M. Jerrett, et al., "Smart growth community design and physical activity in children," *Am. J. Prev. Med.*, vol. 45, pp. 386–392, October 2013.
- [3] T. V. Calise, T. Heeren, W. DeJong, S. C. Dumith, and H. W. Kohl 3rd., "Do neighborhoods make people active, or do people make active neighborhoods? Evidence from a planned community in Austin, Texas," *Prev. Chronic Dis.*, vol. 10, pp. E102, June 2013.
- [4] G. S. Lovasi, et al., "Neighborhood safety and green space as predictors of obesity among preschool children from low-income families in New York City," *Prev. Med.*, vol. 57, pp. 189–193, September 2013.
- [5] Y. L. Michael, R. Gold, N. Perrin, T. A. Hillier, "Built environment and change in body mass index in older women," *Health Place*, vol. 22, pp. 7–10, July 2013.
- [6] S. J. Slater, L. Nicholson, J. Chriqui, D. C. Barker, F. J. Chaloupka, and L. D. Johnston, "Walkable communities and adolescent weight," *Am. J. Prev. Med.*, vol. 44, pp. 164–168, February 2013.
- [7] Selzer et al., *Textbook of Neural Repair and Rehabilitation*, Cambridge University Press, 2006, vol. 1, pp. 602–615.
- [8] M. Hoehner, S. L. Handy, Y. Yan, S. N. Blair, and D. Berrigan, "Association between neighborhood walkability, cardiorespiratory fitness and body-mass index," *Soc. Sci. Med.*, vol. 73, pp. 1701–1716, December 2011.
- [9] T. Hanibuchi, K. Kondo, T. Nakaya, K. Shirai, H. Hirai, and I. Kawachi, "Does walkable mean sociable? Neighborhood determinants of social capital among older adults in Japan," *Health Place*, vol. 18, pp. 229–239, March 2012.
- [10] L. Ada, W. Vattanasilp, N. J. O'Dwyer, and J. Crosbie, "Does spasticity contribute to walking dysfunction after stroke?" *J. Neurol. Neurosurg. Psychiatry*, vol. 64, pp. 628–635, May 1998.
- [11] Selzer et al., *Textbook of Neural Repair and Rehabilitation*, Cambridge University Press, 2006, vol 1, pp. 180–194.



# A Web Mining Approach for Personalized E-Learning System

Manasi Chakurkar<sup>1</sup>

PG student, Department Of Computer Engineering  
MIT, Pune, INDIA

Prof. Deepa Adiga<sup>2</sup>

Assistant Professor, Department Of Computer Engineering,  
MIT, Pune INDIA

**Abstract**—The Web Mining plays a very important role for the E-learning systems. In personalized E-Learning system, user customize the learning environment based on personal choices. In a general search process, a hyperlink which is having maximum number of hits will get displayed first. For making a personalized system history of every user need to be saved in the form of user logs. In this paper we present a architecture with the use of Web mining for Web personalization. The proposed system provides a new approach with combination of web usage mining, HITS algorithm and web content mining. It combines hits results on user logs and web page contents with a clustering algorithm called as Lingo clustering algorithm. This proposed system with combined approach gives a better performance than a usage based system. Further the results are computed according to matrices computed from previous and proposed method.

**Keywords**—Web usage mining; web content mining; web personalization; e-learning system, Lingo; HITS

## I. INTRODUCTION

E-learning is a form of electronic teaching that enables people to learn anytime and anywhere. The objective of an online personalization system is to provide users with the information they require, without asking them explicitly [1]. Web personalization is outlined as any action that adapts the data or services provided by a website to the requirements of a selected user or a collection of users, taking advantage of the information gained from the users guidance behavior and individual interests.

The prominent characteristic of E-learning system is that the students become self-learners and explorers of knowledge. In learning process, learner is the main body but not passive recipient. E-learning system is built on web service related technology and provides all kinds of learning ways to students to realize real-time, interactive and cooperative learning at different places. It should be able to find the individual differences of learners and construct personalized learning environment to meet their individual needs. Therefore, more and more researchers have done much on personalizing learning system [1].

A core part of the personalization method is generation of interested information to users. It's strictly supported as certain patterns, and ensuing probabilities.

Usually used user models are rather simplistic, representing the user as a vector of ratings or employing a set of keywords. Even wherever additional multi-dimensional information has been accessible, like once assembling implicit

measures of interest, the information has historically been mapped onto a single dimension, within the sort of ratings. In particular profiles commonly used lack in their ability to model user context and dynamics. Users rate completely different things for various reasons and under completely different contexts. The user interests and desires amendment with time. Distinguishing these changes and adapting to them may be a key goal of personalization. We recommend that the personalization process be taken to a new level, where the user doesn't to be actively attached the personalization method. All that the user has to do is to register to the system, create own profile and once the user logs onto E-learning system, the browser checks for that profile file as it checks for the cookies. The profile file describes the user's area of interest. Since the profile file is in standardized format, the contents are provided according to the profile file. This is able to enhance the user's personalization method while not their active involvement. The search component of personalized E-learning systems is as shown in figure 1 [8].

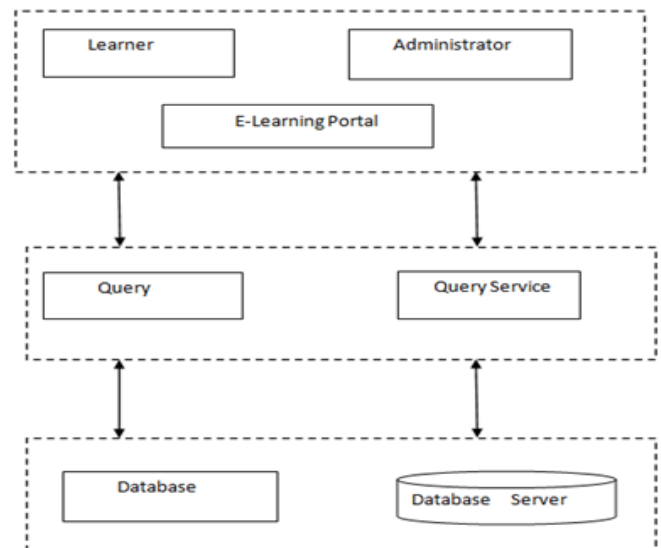

Fig. 1. Search Component Of Service Oriented Reference Architecture For Personalized E-Learning System

The Fig.1 represents search component of service oriented reference architecture for personalized E-Learning System. In e-learning systems, the challenges are increase of complexity and more interoperability between systems in distributed environment. The lacking is reference architecture in which by reusing web services, reusing learning objects etc. A service-



oriented reference architecture describes essence of software architecture and the most significant and relevant aspects. [8]

E-learning portal applications need to present data in a tabular format to the users. The functionality provided by the search component is dynamic query generation based on user input, sort order, joins, etc. There are multiple ways to invoke the query service. All are supported by this protocol. Based on the service description and the protocol, new client interfaces can be easily built according to users' preferences. Learners want search the learning object related to Computer Science, then they have to type 'Computer Science'. By activating the link on the query interface, it obtains the extra services exposed by other providers. [8]

There are variations between layout customization and personalization. In customization, the location is often adjusted to each user's preferences concerning its structure and presentation. Whenever a registered user logs in, his/her customized home page is loaded. This method is performed either manually or semi-automatically. In personalization system advises in [1], modifications regarding the content or maybe the structure of an online web site are performed dynamically.

Therefore a well-designed customized distance education system might have the subsequent characteristics: i) It will find out the learners' study interest, access habits, learning orientation ii) It will change the location map and customize the learners' interface dynamically consistent with the access log iii) It will suggest learning resources by analyzing the learner's interest and learning process iv) It will recommend interested information v) will provide suggestions to assist him/her to regulate teaching set up, teaching model and teaching ways [1]. Principal parts of Web personalization system are firstly, the categorization and preprocessing of Web knowledge, secondly, the extraction of correlations between and across different forms of such knowledge, and finally, the determination of the actions that ought to be counseled by such a personalization system.

This survey of papers is organized as follows. In next section II we are presenting the literature survey over the web mining approach over personalize E-learning system. In section III, the proposed approach and its system block diagram is depicted. In section IV we are presenting the current state of implementation and results achieved. Finally conclusion and future work is predicted in section V.

## II. LITERATURE SURVEY

In this section we are presenting the various approaches those are presented to resolve the web mining approach over personalization of E-learning system.

### A. Web mining techniques

Web Usage Mining: Web Usage Mining is the type of data mining techniques to discover interesting usage patterns from Web data, in order to understand and better serve the needs of Web based applications. Usage data captures the identity of Web users along with their browsing behavior at a Web site.

Some of the typical usage data collected at a Web site called user logs include IP addresses, topic Id, blog Id and access time of the users.

**Web Content Mining:** Web Content Mining is the process of extracting useful information from the contents of Web documents. Content data corresponds to the collection of facts of a Web page was designed to convey to the users. It may consist of text, images, audio, video, or structured records such as lists and tables [9].

A survey of the use of the Web-mining for Web personalization is necessary. More specifically, they introduce the modules that comprise a Web personalization system, emphasizing on the Web usage mining module. A review of the most common methods that are used as well as technical issues which occurred is given, along with the brief overview of the most popular tools and applications available from software vendors. Moreover, the most important research initiatives in Web usage mining and personalization area are presented. But this is not as much effective method for personalization [4].

### B. HITS Algorithm for Detecting Web Communities

HITS (Hyperlink-Induced Topic Search) algorithm, which capitalizes on hyperlinks to extract topic-bound communities of web pages. Despite its theoretically sound foundations, they observed HITS algorithm failed in real applications. In order to understand this problem, Saeko and others developed a visualization tool LinkViewer, which graphically presents the extraction process. [3] This tool helps to reveal that a large and densely linked set of unrelated Web pages in the base set impeded the extraction. These pages were obtained when the root set was expanding into the base set. As remedies for this topic drift problem, prior studies applied textual analysis method. On the other hand, they propose two methods which utilize only the structural information of the Web: 1) The projection method, which projects eigenvectors on the root subspace, so that most elements in the root set will be relevant to the original topic, and 2) The base-set downsizing method, which filters out the pages without links to multiple pages in the root set. These methods are shown to be as robust for broader types of topics and low in computation cost.

### C. Clustering Algorithms - K-means, Suffix Tree and LINGO

The performance of the web search engines could be improved by properly clustering the search result documents. Most of the users are not capable to give the appropriate query to get what exactly they wanted to retrieve. So the search engine will retrieve a massive list of data, which are ranked by the page rank algorithm or relevancy algorithm or human judgment algorithm. The user will always find to self with the unrelated information related to the search due to the ambiguity in the query by the user. Evaluating the performance of the clustering algorithm is not as trivial as counting the number of errors or the precision and recall of a supervised classification algorithm. In this paper comparative analysis is done on three search results of clustering algorithms to study the performance enhancement in the web search engine [5].

D. Concept-Driven Algorithm for Clustering Search Results

Search-results clustering aims to present information about the matching documents. It's like taking a step backward to grasp a bigger picture. They consider no longer care about individual documents, but about some underlying semantic structure capable of explaining why these documents constitute a good result to the query. To find this structure, the Lingo algorithm is used. The Lingo algorithm combines common phrases discovery with latent semantic indexing techniques to separate search results into meaningful groups. It looks for meaningful phrases used as cluster labels and assigns documents to the labels to form groups [6].

III. PROPOSED APPROACH FRAMEWORK AND DESIGN

A. Problem Definition

When the intention behind the search query is not clear, user will get large number of results in return. The user need to be swift through long list of results to find the result that suits his information need. Hence Personalized E-learning system is required to provide interested information to user by web mining technique [7].

B. Existing System based on Usage mining

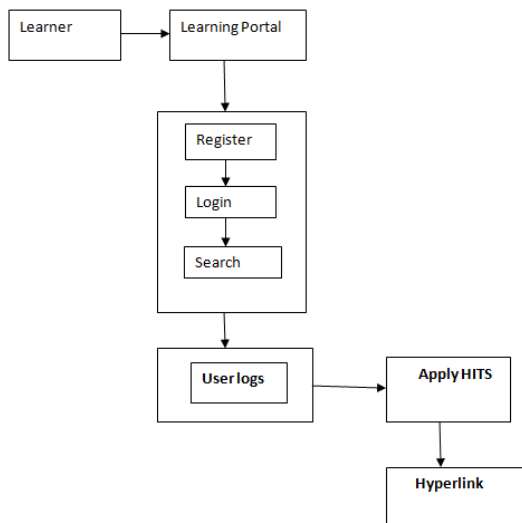

Fig. 2. Existing system based on user logs

Fig. 2 represents existing system which is based on web usage mining. In existing system once user log on to the system, and make search for a particular topic, user logs are saved. On the user logs , HITS algorithm is applied to provide the output in the form of hyperlink. Limitation of this type of system is that web page contents are not considered while giving output to the user. As a result most popular hyperlink with maximum hits will be considered, but that link may have contents which are not related to user’s interest.

C. Proposed Architecture

The objective of this approach is to provide users with the information they want or need, without expecting from them to ask for explicitly [1]. To overcome the above stated problem, we propose an architecture, which combines web usage mining and web content mining techniques. Fig. 3

represents proposed architecture for personalized E-learning system combining HITS algorithm on user logs and Lingo clustering algorithm.

Admin is responsible for forming a standard dataset including learning objects. This dataset is preprocessed by removing stop words and stemming. A new user first makes registration to the learning portal. When user login to the system using his own user name and password and search for a particular topic, at server side user logs are stored for that search. Then HITS algorithm is applied to those logs to increase the weight of that log. For proposed approach, preprocessed data is given to content mining using Lingo clustering algorithm. Clusters are formed from preprocessed data. Final results are calculated by combing user logs, Hits algorithm and clustering results.

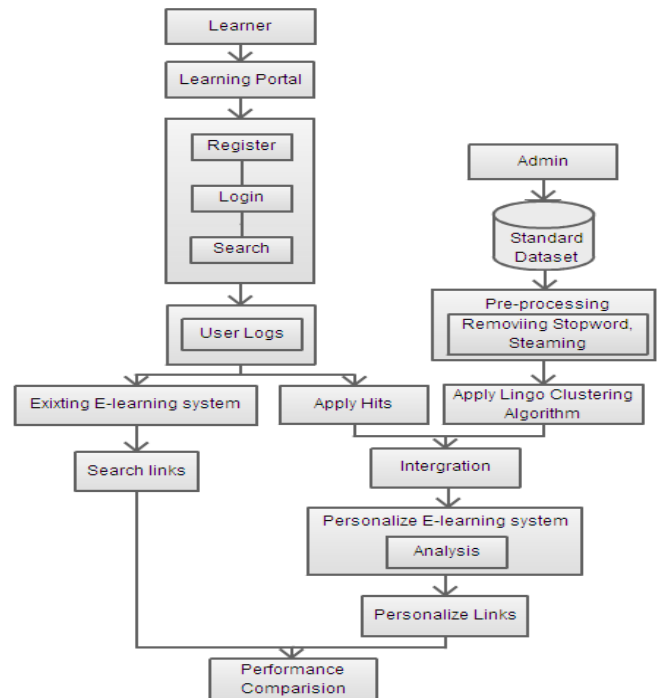

Fig. 3. Architecture of proposed approach

This combined approach gives a better performance as compared to existing E-learning system which is based on usage mining.

D. Mathematical Model

Algorithm: HITS (Hyper-link Induced Topic Search) algorithm

Input: Search String query.

Process:

1) Sampling Step

$$B(p) = \sum_{i=0}^n R(q)_i$$

where B(p) is the set of relevant pages and R(q) is the result of given query.

2) Iterative Step

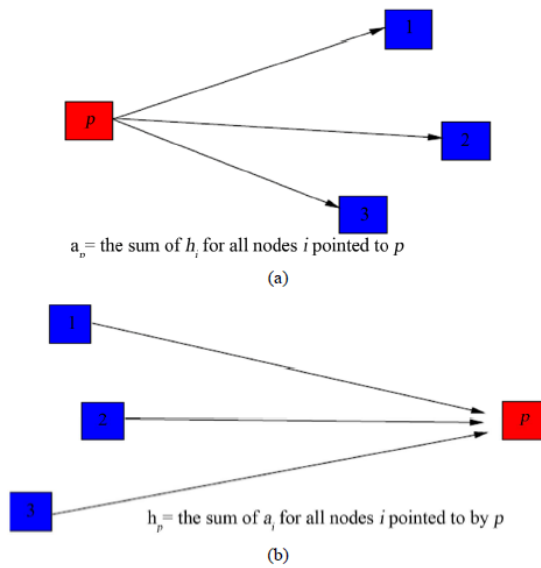

Fig. 4. Dynamic weight updation

For (each result of query)

$$H_p = \sum_{q \in I(p)} A_q$$

$$A_p = \sum_{q \in B(p)} H_q$$

where  $H_q$  is Hub Score of a page

$A_q$  is authority score of a page,

$I(p)$  is set of reference pages of page  $p$  and

$B(p)$  is set of referrer pages of page  $p$ ,

end for

Output: max hit queried page.

Algorithm: Lingo Clustering Algorithm

Input:

User search query ( $q$ ), term ( $t$ ), word ( $w$ ), Number of clusters  $k$ , *teaming words*  $St_{SW}$ , Set of stopwords

$S_{SW} = \{ "i", "a", "about", "an", "and", "as", \dots \}$ ,

Process:

1) Preprocessing:

a) Remove stop words

If ( $q$  contains  $S_{SW}$ ) then  
Remove word.

b) If ( $q$  contains  $St_{SW}$ ) then

Rewrite word removing steaming

c) If ( $q$  contains phrase) then

Extract that phrase

2) Apply Lingo clustering Find clusters and label using Vector Space Model along with the Latent Semantic Indexing (LSI) technique.

a) Convert input query to  $tf - idf$ .

$tf_{t,d}$  = number of occurrence of term  
in document  $d$

$$idf_t = \log_{10} \frac{N}{dft}$$

where  $dft$  is document  $d$  that contain a term  $t$

$$tf - idf_{t,d} = tf_{t,d} * idf_t$$

b) Create data structure indexed by document ( $d$ ).

c) For each  $t$

Update entry in score

$$score[d] = score[d] + tf = idf(t, d) * tf - idf(t, d)$$

Normalize score

$$Magnitude[d] = \frac{score[d]}{\sqrt{score[d]^2}}$$

End for

d) For each  $d$

Calculate cosine similarity

$$\cos(\vec{q}, \vec{d}) = \frac{\vec{q} \cdot \vec{d}}{|\vec{q}| |\vec{d}|} = \frac{\sum_{i=1}^{|\vec{q}|} q_i d_i}{\sqrt{\sum_{i=1}^{|\vec{q}|} q_i^2} \sqrt{\sum_{i=1}^{|\vec{d}|} d_i^2}}$$

Where,

$q_i$  is the  $tf - idf$  weight of term  $i$  in the query.

$d_i$  is the  $tf - idf$  weight of term  $i$  in the  $d$ .

end for.

Output: Clusters.

#### IV. WORK DONE

In this section we are discussing experimental analysis, performance metrics used and computed results etc.

A. Experimental Analysis:



Fig. 5. Home page of Personalized E-learning system

As shown in Fig. 5, this is home page of personalized E-learning system. There are two different logins as user login and Admin login. After registration user can login and search for a particular topic

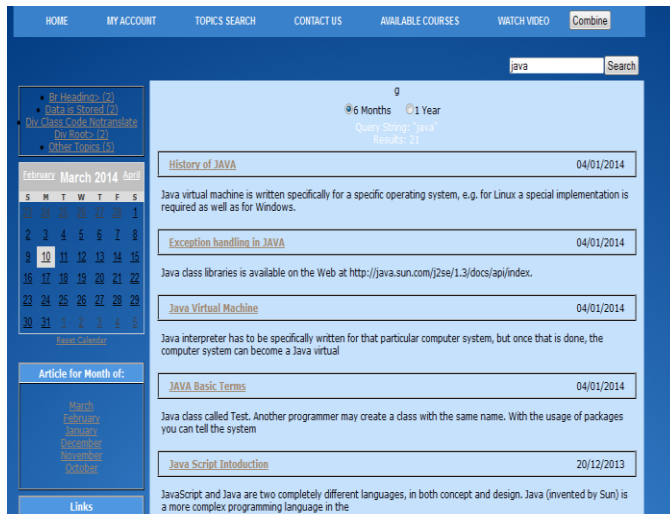

Fig. 6. Search results for java keyword with combined approach

As shown in Fig. 6, when users search for java keyword, he gets different links. When user selects a combined approach,

More accurate links are available to user, which results in personalized output.

**B. Results for precision of combined system against content based system:**

**C. Matrix measure**

To evaluate the effectiveness of the approach, performance is measured using two factors like Precision, Random Index.

Precision (P):

The percentage of retrieved documents that is in fact relevant to the query (i.e., “correct” responses).

$$precision = \frac{|\{Relevant\} \cap \{Retrieved\}|}{|\{Retrieved\}|}$$

Random Index (RI):

The Rand index measures the percentage of decisions that are accurate

$$RI = \frac{(TP + TN)}{(TP + TN + FP + FN)}$$

A true positive (TP) decision assigns two similar documents same cluster. True negative (TN) decision assigns two dissimilar documents to different clusters. (FP) decisions assign two dissimilar documents to same cluster. A (FN) decision assigns two similar documents to different clusters [7].

**D. Results of work done**

The comparative study between existing system based on usage mining and proposed system with combined approach are as shown in following figure.

Ambient (ambiguous entries) dataset is used as standard dataset for finding search results. Dataset contain many queries, results of few queries are as follows.

Results for precision of combined system against usage based system:

Sr. No.	Topic	Total links	Correct	Incorrect	Combined %	Total	correct	Incorrect	Usage based %
1	java	26	13	13	50	20	8	12	40
2	object	16	10	6	65	10	6	4	60
3	php	19	11	8	58	14	7	7	50
4	php forms	16	8	8	50	12	6	6	50
5	sql	22	13	9	60	22	12	10	55
6	Asp.net	20	13	7	65	16	10	6	60
7	xml	24	10	14	40	18	6	12	35
8	java script	15	9	6	60	14	8	6	60
9	micro	12	5	7	40	9	3	6	30
10	events	14	7	7	50	10	4	6	40

Fig. 7. Values for searched topics for precision

**Graph for precision**

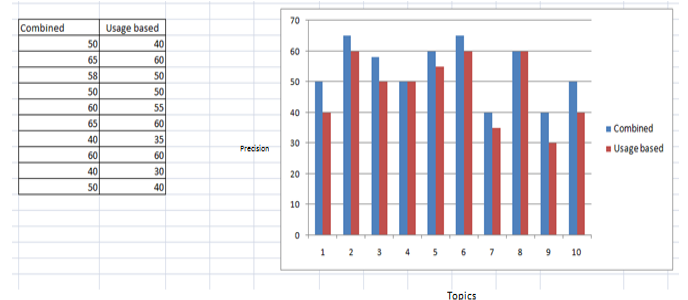

Fig. 8. Graph for precision analysis

**V. CONCLUSION AND FUTURE WORK**

This paper proposes a combined approach for personalized E-learning system based on web usage mining and web content mining. In this approach weight associated with a hyperlink is assigned by considering equal percentage of web usage mining and web content mining. User logs are saved at server side, which helps to provide personalized output with area of interest of the user. HITS algorithm is applied to user logs to increase weight of that hyperlink. At the same time, contents of a web page are preprocessed and clustering results are combined with hits a result which gives more accurate results.

The performance of the system is evaluated under different settings and in comparison with the previous method which is based only on the usage mining. The application can be used for personalized recommendation to give personalized recommendation based on users browsing history. Throughout this paper we have discussed many aspects of research for personalized E-learning system. Based on existing limitations, in this paper a new web mining approach based on combination of web usage mining and web content mining is presented which is showing the better performance improvement as compared to the existing method.

In future we discover the learner's time distribution pattern to realize personalized curriculum organization, discover the learning behavior pattern to build up a series of feedback and motivation system and we will give different training according to different learners' levels.

**REFERENCES**

[1] Yuewu Dong, Jiangtao Li, “Personalized Distance Education System Based on Web Mining”, International Conference on Education and Information Technology (ICEIT 2010), IEEE, 2010

- [2] Maurice D. Mulveny , Sarabjot S Anand and Alex G. Buchner, "Personalization on the Net using Web Mining," Communications of the ACM, vol. 43, No. 8, 2000.
- [3] Magdalini Eirinaki and Michalis Vazirgiannis, "Web Mining for Web Personalization," ACM Transactions on Internet Technology, vol. 3, No. 1, February 2003.
- [4] Saeko Nomura Satoshi Oyama Tetsuo Hayamizu Toru Ishida, "Analysis and Improvement of HITS Algorithm for Detecting Web Communities", Department of Social Informatics, Kyoto University Honmachi Yoshida Sakyo-ku, Kyoto, 606-8501 Japan@kuis.kyoto-u.ac.jp, ishida@i.kyoto-u.ac.jp
- [5] R.Mahalakshmi, V.Lakshmi Praba, "A Relative Study on Search Results Clustering Algorithms - K-means, Suffix Tree and LINGO", 6, August 2013
- [6] Stanislaw Osiński and Dawid Weiss, "A Concept-Driven Algorithm for Clustering Search Results", 2005 IEEE
- [7] Sri Shilpa admanabhuni, Hima Bindu T, "Search Results Clustering: Comparison of Lingo and K-Means", Volume 1, Issue 5, October 2013.
- [8] K. Palanivel, S. Kuppaswami , " Service-Oriented Reference Architecture for Personalized E-learning Systems (SORAPES) ", International Journal of Computer Applications (0975 – 8887) , Volume 24– No.5, June 2011
- [9] A.Jebaraj Ratnakumar , "An Implementation of web personalization using web mining techniques", Journal of Theoretical and Applied Information Technology, 2005 - 2010 JATIT.
- [10] Mr.Ramesh Prajapati, "A Survey Paper on Hyperlink-Induced Topic Search (HITS) Algorithms for Web Mining", International Journal of Engineering Research and Technology (IJERT), Vol. 1 Issue 2, April – 2012
- [11] Kavita D. Satokar, Prof.S.z.Gawali, "Web Search Result Personalization using Web Mining", International Journal of Computer Applications (0975 - 8887), Volume 2 - No.5, June 2010.
- [12] K. Sridevi, R. Umarani, V.Selvi, "An Analysis of Web Document Clustering Algorithms", International Journal of Science and Technology, Volume 1 No.6, December 2011.

# Audio Content Classification Method Research Based on Two-step Strategy

Sumei Liang

Department of Computer Science and Technology  
Chongqing University of Posts and Telecommunication  
Chongqing, China

Xinhua Fan

Department of Computer Science and Technology  
Chongqing University of Posts and Telecommunication  
Chongqing, China

**Abstract**—Audio content classification is an interesting and significant issue. Audio classification technique has two basic parts: audio feature extraction and classifier. In general the audio content classification method is firstly to identify the original audio into text, then use the identified text to classify. But the text recognition rate is not high, some words that good for classification are identified by mistake causing that the classification effect is not ideal. In order to solve these problems above, this paper proposes a new effective audio classification method based on two-step strategy. In the first step the features are extracted by using the improved mutual information and classified with Naïve Bayes classifier. After classification of the first step, an unreliable area is determined, and samples with features in this area go on to be classified with the second step. In the second step, textual features extracted with CHI statistic method are used to build a text feature space model. Then audio features containing MFCC and frame energy are combined together with the text features to build a new feature vector space model. Finally, the new feature vector space model is classified using Support Vector Machine (SVM) classifier. The experiments show that the two-step strategy classification method for audio classification achieves great classification performance with the accuracy rate of 97.2%.

**Keywords**—Two-step Strategy; Audio classification; MFCC; Frame energy; Naive Byes; Support vector machine (SVM)

## I. INTRODUCTION

With the high-speed development of information industry, the digital information grows rapidly. People have urgent demand on the process of digital information. Images, video and audio are the main forms of media in the field of information processing, and audio occupies very important position. How to quickly grasp the most effective information is an important problem people have to be faced with. Because the audio classification can solve the problems of information clutter to a certain extent and it is convenient for users to accurately locate the required information, it has become a key practical technology. For example, in the telephone booking and mobile service hotline, proprietor can evaluate employee's job performance according to the employee's contents, attitude, tone in the phone etc. At the same time it plays an important role in speech retrieval and the depth of the speech information processing with a broad application prospect. Typical audio classifiers used in the related papers contain Minimum Distance method, Support Vector Machine (SVM), neural network, Decision Tree method and the Hidden Markov Model[1][2][3][4] etc.

Currently audio content classification research mainly has two directions: one method is firstly to recognize the audio into text, and then classify the text after the identification; the other method is directly to use audio features, such as MFCC, frame energy, and pitch frequency and so on to classify audio. However using the text recognized form the audio information to classify in the first method has some problems in the following.

- The recognition rate of the first method is not high.
- Some words that contribution to the classification are recognized by mistake.
- The classification method is usually in single step classification strategy.

These problems cause that the classification effect is not ideal. Fan XingHua[5] etc proposed a new highly effective two-step Chinese text classification method; it achieved good effect in Chinese text classification research. This paper considers importing this two-step classification strategy into audio classification, and verifying the actual classification effect through experiment.

It is focused on applying the two-step classification strategy in audio classification in this paper. There are several problems needed to be studied.

- Whether the texts after identification are the same as plain texts with the phenomena that most misclassified ones are in a fuzzy region constituted in the two-dimensional space structure.
- Whether audio features such as MFCC, frame power could be effective for audio content classification.
- Text features of texts identified from audio are fewer than features of the plain texts, and especially some words with excellent contribution to the classification are recognized by mistake. These problems cause the classification effect in the first step is not ideal. Whether the combine of text features and audio features such as MFCC and frame energy could enhance the accuracy of audio content classification in the second step.
- Whether this two-step classification strategy for audio classification is feasible.

To aim of solving the above problems, we proposed a new audio classification method based on two-step strategy



combining text features and audio features. At last the method is studied with Naive Bayes and Support Vector Machine classifiers. The basic fundamental is as follows: in the first step improved mutual information is used to extract the characteristics, and the Naïve Bayes classifier is used for classifying. If the classification result of the first step is reliable the classification decision will be given, otherwise the samples will go to the second step. In the second step it combines audio features MFCC, frame energy with text features selected with CHI statistic formula as the total classify features, then uses Support Vector Machine classification method to classify. In the end, the final classification judgment is given according to the results of the two steps.

## II. CHARACTERISTIC ANALYSIS IN THE AUDIO CONTENT CLASSIFICATION

According to the analysis of sports audio and news audio, it is found that usually there are some special unsteady sounds in the sports audio such as whistle, sonorous voice of narrator and cheers etc. Oppositely the news audio usually is relatively stable, and the kinds of sounds above don't exist. These voices contain rich semantic information and can be very useful to distinguish these two types of audio. Through the experiments, it is proved that audio features MFCC, frame energy under different audio category have obvious distinguish ability.

### A. Frame Energy

Short-time Energy[6][7] is the energy focused by the sample signal in a short audio frame. Sequence of Short-time energy reflects the detailed change rule of the voice amplitude or energy over time.

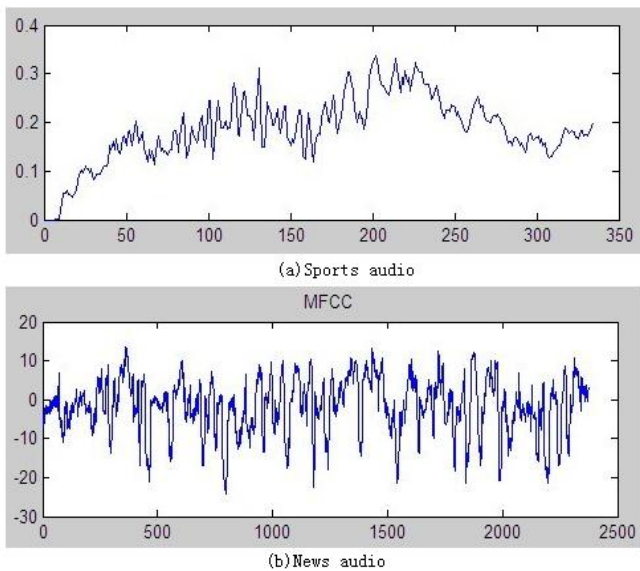

Fig. 1. the distribution curve of frame energy

Figure1 (a) and (b) respectively describe the short-time energy distribution curve of these two types of audio. The Energy of sports audio generally is high, and the amplitude usually changes slowly. On the other hand the energy distribution of the news audio is relatively concentrated, and amplitude changes quickly. Actually there are a lot of sounds such as whistle, sonorous voice of narrator and cheers in the

sports audio, but news audio rarely appears this kind of sounds through analysis. Because of these differences their energy distribution curves are obviously different between with each other. According to the above analysis Short-time Energy can be considered as the feature used to classify the audio.

### B. Mel Frequency Cepstrum Coefficient

Mel frequency cepstrum coefficient (MFCC) [8][9] is the cepstrum parameters extracted from the Mel scale frequency domain, and also a kind of perception frequency cepstrum parameters. In order to accord with the human's auditory characteristics, MFCC generally adopts the triangular filter group to filter the energy coefficient of Fourier Transform, and do the Mel scale transformation for frequency domain. MFCC coefficient is firstly used for speech or speaker recognition, but the results of literature [10][11] show that MFCC coefficient can improve the accuracy of audio content classification

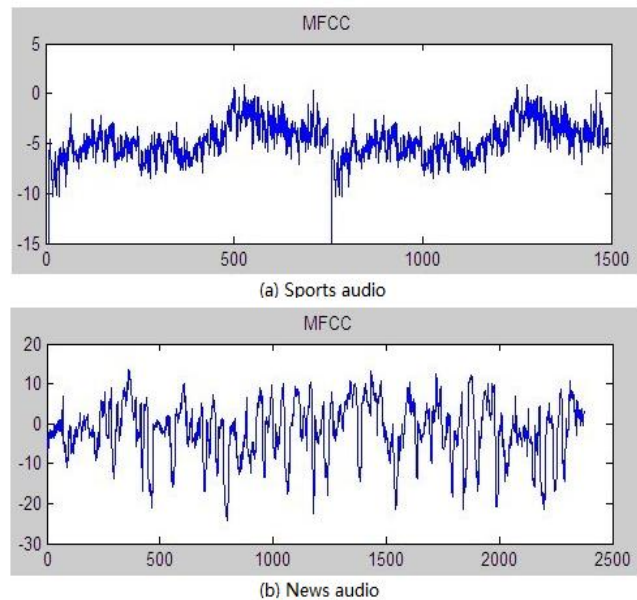

Fig. 2. one-dimensional map of MFCC feature

Lu Jian [12] puts forward a kind of audio classification method based on Hidden Markov Model. That paper pointed out that the difference of MFCC coefficient  $\Delta$  MFCC could well reflect the dynamic change characteristics of audio signal with the calculation and analysis of multi-stage MFCC and the difference coefficient  $\Delta$ MFCC, so they can be used to revealed the time statistical properties of different types of audio.

Figure2 (a) and (b) respectively represent the short MFCC feature of sports audio and news audio in one dimensional mapping. Through the compare of these two pictures it can be found that the MFCC feature mapping values of sports audio jump densely in a short local area and amplitude is small. Oppositely MFCC feature mapping values of news audio jump sparsely densely in a short local and the amplitude is much larger. These differences prove that the MFCC features can reflect the rich semantic characteristics, and the most important of all they have good distinction between two types of audio category.



### III. AUDIO CLASSIFICATION METHOD BASED ON TWO-STEP STRATEGY

#### A. The Rewriting for two types of Naïve Bayes Classifier

Given a binary text vector  $d=(w_1, w_2, \dots, w_D)$ ,  $w_i=0$  or 1. If the  $i$ th feature appears in the text  $w_i=1$ , otherwise  $w_i=0$ ,  $P_{ki}=P(w_k=1/c_i)$ ,  $P(\cdot)$  means the probability of event  $(\cdot)$ . The discrimination function for two types of Naïve Bayes classifier can be expressed as follows:

$$f(d) = \log \frac{P(c_1/d)}{P(c_2/d)} = \log \frac{P(c_1)}{P(c_2)} + \sum_{k=1}^{|D|} \log \frac{1-P_{k1}}{1-P_{k2}} +$$

$$\sum_{k=1}^{|D|} W_k \log \frac{P_{k1}}{1-P_{k1}} - \sum_{k=1}^{|D|} W_k \log \frac{P_{k2}}{1-P_{k2}}$$

When  $f(d) \geq 0$ , text  $d$  belongs to type  $c_1$ . Otherwise it belongs to type  $c_2$ .

#### B. The design of the Support Vector Machine SVM Classifier

The principle of Support Vector Machine (Support Vector Machine) [13] can be simply described as follows: it hopes to seek a hyper plane which can separate positive samples from negative samples in the training set with the largest blank space on either side. It is given a set of training samples as follows.

$$T = \{(x_i, y_i)\} \in (R^n \times Y)^l$$

$$\text{s.t } x_i \in R^n, i=1, \dots, l$$

If  $y_i \in Y = \{1, -1\}$ , SVM becomes the process of constructing hyperplane  $(w \cdot x) + b = 0$  which separates the two types of sample points. Among them, the distance from the nearest point in the samples to the hyperplane is called interval, as shown in the Figure 3.

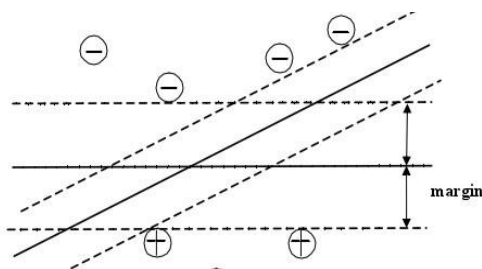

Fig. 3. SVM schematic diagram

#### C. The observations of misclassification samples in the first step

In this two-step strategy classification method, in the first the Hidden Markov Model is used for speech recognition in which the audio samples are recognized to the texts. The improved mutual information formula is used for feature selection of identified texts in the first step in order to get the Binary text vector, then the Bayes classifier in part A is used to classify. In order to study and analysis the result of

classification in the first step, the formula (1) is took apart and two posterior probability parameters representing the probability where one sample belongs to one of two types are respectively fetched out as follows.

$$X = \sum_{k=1}^{|D|} W_k \log \frac{P_{k1}}{1-P_{k1}} \quad (2)$$

$$Y = \sum_{k=1}^{|D|} W_k \log \frac{P_{k2}}{1-P_{k2}} \quad (3)$$

$$\text{con} = \log \frac{P(c_1)}{P(c_2)} + \sum_{k=1}^{|D|} \log \frac{1-P_{k1}}{1-P_{k2}} \quad (4)$$

$X$  represents posterior probability where the text  $d$  belongs to type  $c_1$ , and  $Y$  represents posterior probability where the text  $d$  belongs to type  $c_2$ .  $\text{Con}$  is a constant only related to the training samples set, and would not be changed by text  $d$ . So the formula (1) can be rewritten as follows.

$$f(d) = X - Y + \text{con} \quad (5)$$

Formula (5) represents that the two-step Naïve Bayes classifier can be viewed as a process of seeking a straight line  $f(d) = 0$  in two-dimensional space constituted by  $X$  and  $Y$ . In this way, sample text can be expressed as a single point  $(x, y)$  in the two-dimensional space determined by formula (2) and formula (3), the distance  $\text{Dist}$  from this point to dividing line  $f(d) = 0$  is as follows.

$$\text{Dist} = \frac{1}{\sqrt{2}}(x - y + \text{con}) \quad (6)$$

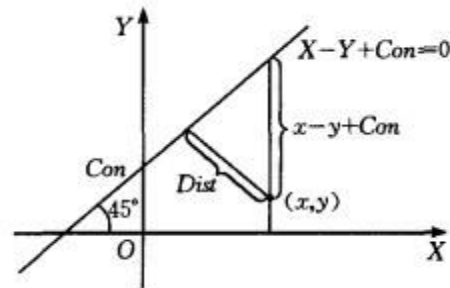

Fig. 4. the distance from the text point to the dividing line.

As shown in Figure 4, sample text  $d$  belongs to type  $c_1$  when  $\text{Dist} \geq 0$ , sample text  $d$  belongs to type  $c_2$  when  $\text{Dist} < 0$ .

The purposes that the formula (1) is changed to the formula (5), and then evolved into formula (1) are as follows.

- Taking advantage of formula (6) can easily investigate and analyze text classification error, and discuss the relationship between the distance  $\text{Dist}$  and the

classification error in the condition of a given classification method and textual features set in the two-dimensional space made up of  $X$  and  $Y$ .

- It is convenient to assess the relationship of reliability of classification and the value of the distance  $Dist$  and determine the unreliable part of the classification results in the first step by taking advantage of formula (6).

In this paper  $C_1$  and  $C_2$  respectively represent for sports category and news category. Using the corpus in the experimental section as samples set, distribution of the text after identification can be calculated in the two-dimensional space with  $X$  as the abscissa value and  $Y$  as the ordinate value as shown in Figure 5. Figure 5 (a) and Figure 5 (b) respectively corresponding to the distribution of sports audio and the news audio. It can be seen from the figure that two types of audio are distributed on two sides of the dividing line in two-dimensional space. The texts after identification classified by mistake are located in the above area of dividing line in Figure 5 (a) and in the below area of dividing line in Figure 5 (b). Through observing of these texts it is clear that the samples classified by mistake mainly concentrate in the area very close to the dividing line.

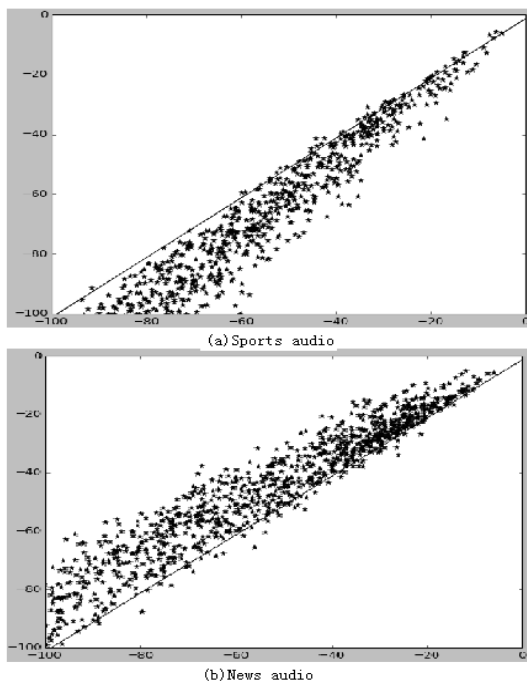

Fig. 5. the distribution of identified text

Fan XingHua [5] puts forward most of the errors are in a narrow area close to the dividing line in the plain text classification study. That is to say, if the texts whose distance are very close to the dividing line are got rid of, then the test performance of the classifier will be improved. This assumption has been proven by experiments. This paper imports this idea to the first step of classification process in which the text after speech recognition is classified. According to the observation of the Figure 5, it is assumed that the performance of the classifier is relate to the distance  $Dist$

calculated by formula (6), and major errors happen in the narrow area close to the dividing line.

*D. The method of determining the unreliable area after classification of the first step*

Through the observation of classified result in the first step of classification process it can be seen that the samples are classified by mistake mainly concentrated on the area close to the dividing line. A range where  $Dist$  values are near to zero can be determined as the unreliable area in the first step of classification process, and then decision whether reliable or unreliable can be made. Formula (7) is the discriminant formula for classification.

$$\begin{cases} Dist1 \leq dist \leq Dist2 & \text{the classification is unreliable} \\ dist \text{ for other values} & \text{the classification is reliable} \end{cases} \quad (7)$$

In order to get the most optimal boundary constant  $Dist1$ ,  $Dist2$ , two evaluation indexes are introduced: error rate and area percentage.

Error Rate:

$$ER(dist1, dist2) = \frac{EC(dist1, dist2)}{EC\_CON} \times 100\%$$

Area Percentage:

$$RP(dist1, dist2) = \frac{T(dist1, dist2)}{T\_CON} \times 100\%$$

$EC(dist1, dist2)$  is the count of the samples that are classified by mistake with the  $Dist$  value in the range of  $[dist1, dist2]$ .  $EC\_CON$  is the total number of samples that are classified by mistake.  $T(dist1, dist2)$  is the count of samples with the  $Dist$  value in the range of  $[dist1, dist2]$ .  $T\_CON$  is the total number of all test samples.

In order to conveniently draw the curve lines that show changes of ER and RP following  $Dist$  range, one of two endpoints could be fixed to a constant value. Using the corpus in the experimental section as samples, Figure 6 shows the curves of ER and RP with the fixed constant value of zero. The curve lines on the right side of  $Y$  axis reflect the changes of ER and RP following  $dist2$  value when the value of  $dist1$  is zero, and similarly curve lines in the other side  $Y$  axis reflect the changes of ER and RP following  $dist1$  value when the value of  $dist2$  is zero. Through observation of Figure 6 can be seen that the ER grows rapidly when the value of  $dist2$  is small, and then gradually stabilizes form the inflection point. The situation in the left of  $Y$  axis is the same as the right of  $Y$  axis. The value of ER in position of right inflection point with the  $dist2$  value of 5 is 49% meaning 49% samples(sports samples) classified by mistake are concentrated on the range of  $[0,5]$ , and RP is 15% meaning the sports samples whose  $Dist$  values are in the range of  $[0,5]$  account for 15% of the total test samples. The inflection point on the other side is the position with  $dist2$  value of - 4, where the ER and RP values are 47% and 19%

respectively. It means that 47% samples (news samples) classified by mistake are concentrated on the range of [-4, 0] where samples account for 19% of the total test sample. To sum up, the 97% part of samples wrongly classified distribute on the scope of the [-4, 5], and at the same time samples whose *Dist* value are in this area of only account for 34% of all samples. Therefore, the two inflection points' values are fairly appropriate to be as the endpoint value of unreliable area for formula (7).

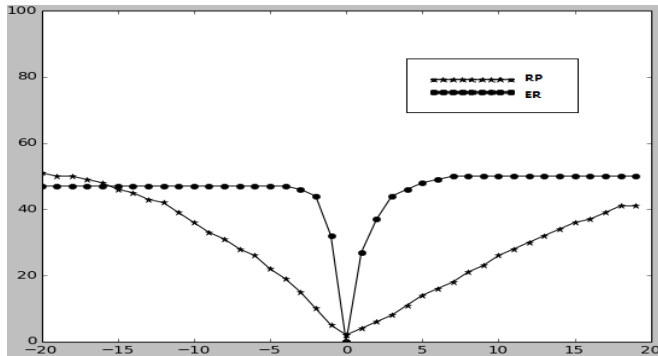

Fig. 6. ER and RP curve changed with distance *Dist*

#### E. The characteristics of the two-step classification method

The most significant value of two-step classification method put forward in this paper is able to mix text and audio features together for classifying. Generally the traditional method firstly recognizes the audio into text, does feature extraction and chooses an appropriate classifier to classify. But the recognition rate is not high and some words that well contribute to the classification are recognized by mistake or recognized to other homophones, these problems cause that the classification effect is not ideal. According to the analysis of two kinds of audio, it is found that there are usually some special unsteady sounds in the sports audio such as whistle, sonorous voice of narrator and cheers etc. Oppositely the news audio is usually relatively stable, and these kinds of sounds don't exist in general. Through the experiment, it is proved that the audio features containing MFCC and frame energy have good ability to distinguish raw audio differences above. Two-step strategy classification method in this paper effectively combines audio and text features with each other in order to get a high performance classification.

### IV. EXPERIMENT

#### A. The Experiment Database

The audio corpuses used in the experiment are all from the real environment context. Sports corpus is mainly from CCTV live program basketball and soccer sports events and news corpus are from CCTV news broadcast program. There are 1050 sports audio samples and 1200 news audio samples. The proportion of training samples and testing samples is 3:1 on the experiment. In order to ensure the uniformity of training samples and testing samples, the training sample and test samples are obtained in a cross way. Sampling frequency is 16 KHZ, and capacity of data is 491 MB.

#### B. Evaluation index

The accuracy performance of classification can be measured in the following index: the classification accuracy of one category and the average classification accuracy. The definitions are as follows:

$$\text{accuracy of } C_i = \frac{\text{count of } C_i \text{ samples predicted to be } C_i}{\text{count of samples predicted to be } C_i}$$

$$\text{average accuracy} = \frac{\sum \text{count of } C_i \text{ samples predicted to be } C_i}{\text{the total number of test samples}}$$

#### C. Experiment steps of Two-step classification method

- Design and implement the continuous Chinese speech recognition system based on HTK. The speech recognition rate is 78.04% in this paper's experiment.
- Complete feature extraction using the enhanced mutual information formula for the text after identification.
- Use the improved Naïve Bayes classifier for the first step.
- Analyze and observe the experiment result in the first step, and get a good boundary of unreliable area.
- According to the boundary of the unreliable area, determine a fuzzy region.
- Use the SVM classifier to classify the samples in the fuzzy region in the second step.
- Make the final classification decision.

#### D. Analysis of experimental results

This paper has done the classification experiments by five kinds of methods:

- Method 1: extract text features using the improved mutual information formula, and use Naïve Bayes classifier to classify the audio.
- Method 2: use audio features containing MFCC and frame energy to construct vector space model, and use the SVM classifier to classify the audio.
- Method 3: use CHI statistic formula to extract text features, and combine two kinds of features including audio features containing MFCC、frame energy and text features to construct vector space model. At last use the SVM classifier to classify the audio.
- Method 4: Use Two-step strategy method combining method 1 with method 2 to classify the audio.
- Method 5: Use Two-step strategy method combining method 1 with method 3 to classify the audio.

TABLE I. THE CLASSIFICATION RESULTS

Classification Method	Sports	News	Average accuracy rate
Method 1	90.77%	88.78%	89.72%
Method 2	81.15%	85.96%	83.84%
Method 3	95.65%	93.23%	94.16%
Method 4	96.75%	95.32%	95.79%
Method 5	97.76%	96.62%	97.2%

The table 1 shows the results of five kinds of classification methods. Through analysis of method 2's experiment results it can be seen that the performance of the method using only audio features to classify is not good. The contrast of results of method 2 and method 3 shows that combining two kinds of features including text features and audio features with each other simply can well improve the classification effect.

According to the compare of classification effects of method 4 with method 1 and method 2, it can be seen that the addition of audio features improves the problem that the accuracy rate is not high because of the inaccuracy in text information identification. Obviously it comes to a very import conclusion that the classification accuracy rate of Method 4 based on two-step strategy has great classification accuracy promotion. This conclusion applies to the contrast method 5 with method 1 and method 3 at the same time. What's more, the difference between Method 5 and Method 4 is that Method 5 imports text features again in the second step of classification process in order to get a larger number of classification features in the second step. The contrast of results of method 4 and method 5 shows that importing the text features for samples in the unreliable area of the first step can achieve a better correction effect.

## V. CONCLUSION

As a main form of media audio plays an import role in the field of information processing. Audio classification has become a hot practical technology with a wide application prospect in the fields of speech retrieval, deep voice information processing. In general the audio content classification method is firstly to identify the original audio into text, then use the identified text to classify. But the text recognition rate is not high, some words that are good for classification are identified by mistake causing that the classification effect is not ideal. This paper provides a new effective audio content classification method based on two-step strategy.

The basic fundamental is as follows: in the first step improved mutual information is used to extract the

characteristics, and the Naïve Bayes classifier is used for classifying. If the classification result of the first step is reliable the classification decision will be given, otherwise the samples go to the second step. In the second step it combines audio features MFCC, frame energy with text features selected with CHI statistic formula as the total classify features, then uses Support Vector Machine classification method to classify. Through the experiments, it comes to a conclusion that the audio content classification method based on two-step strategy in this paper is effective in enhancing the performance of audio content classifying, and it can achieve the great classification performance with the classification accuracy rate of 97.2%.

## REFERENCES

- [1] K.Subashini,S.Palanivel,V.Ramalingam,“Audio-video based segmentation and classification using SVM,” 2012 Third International Conference on Computing Communication & Networking Technologies (ICCCNT),vol., no., pp.1-6, 26-28 July 2012
- [2] T.Giannakopoulos, D.I.Kosmopoulos, A.Aristidou,and S. Theodoridis, “A multi-class audio classification method with respect to violent content in movies using bayesian networks,” in IEEE Workshop on MSP, pp.90-90, 2007.
- [3] Kiranyaz.S, Ahmad Farooq Qureshi, Gabbouj.M, “A generic audio classification and segmentation approach for multimedia indexing and retrieval,” IEEE Transactions on Audio, Speech and Language Processing, vol.14(3), pp.1062-1081, 2006.
- [4] B.Liang, SY.Lao, HX.Liao, JY. Chen, “Audio Classification and Segmentation for Sports Video Structure Extraction using Support Vector Machine,” 2006 International Conference on Machine Learning and Cybernetics, pp.3303-3307, 2006.
- [5] XH. Fan, and MS. Sun, “A high performance two-class chinese text categorization method,” Journal of Computers, China, vol. 29(1), pp. 124-131, 2006.
- [6] Umamathy,K, Krishnan,S, Rao,R.k. “Audio Signal Features Extraction and Classification Using Local Discriminant Bases,” IEEE transactions on audio, speech and language processing, vol.15(4) , pp.1236-1246, 2007.
- [7] U.Shravankar, V.Thakare, "Feature Extraction for a Speech Recognition System in Noisy Environment: A Study", ICCEA, pp.358-361, 2010.
- [8] S. Jothilaskmi, S. Palanivel, V. Ramalingam, “Unsupervised speaker segmentation with residual phase and MFCC features,” Expert System With Applications, India, pp. 9799-9804, 2009
- [9] H. Cao, C. Xu, X. Zhao, SJ. Wu. “The Mel-frequency cepstral coefficients in speaker recognition,” XiAn: Journal of northwest university (natural science edition), vol.43, , pp.203-208, 2013
- [10] SahamiM, Dumais S, Hecheman D, Horvitz E. “A Bayesian approach to filtering junk E-mail,” Madison Wisconsin AAAI Technical Report WS-98-05, pp.55-62. 1998
- [11] Li, S.Z. “Content- Based classification and retrieval of audio using the nearest feature line method,” IEEE Transactions on Speech and Audio Processing, vol.8(5), pp.619~625. 2000
- [12] J. Lu, YS. Chen, ZS. Sun, FY. Zhang. “Automatic audio classification based on Hidden Markov Model,” Beijing: Journal of software, vol.13(8), pp.1593-1597, 2002.
- [13] Subashini. K, Palanivel.S, Ramalingam.V, ”Audio-video based segmentation and classification using SVM,” 2012 Third International Conference on Computing Communication & Networking Technologies(ICCCNT), pp.1-6,26-28, .2012.

# Open Vehicle Routing Problem by Ant Colony Optimization

Er. GurpreetSingh<sup>1</sup>

Lecturer, Deptt. of CSE<sup>1</sup>  
SBBSIET<sup>1</sup> Padhiana, Punjab,  
India<sup>1</sup>

Dr. Vijay Dhir<sup>2</sup>

Associate Professor & Head, Deptt. of CSE<sup>2</sup>  
SBBSIET<sup>2</sup> Padhiana, Punjab,  
India<sup>2</sup>

**Abstract**—Vehicle routing problem (VRP) is real-world combinatorial optimization problem which determine the optimal route of a vehicle. Generally, to provide the efficient vehicle serving to the customer through different services by visiting the number of cities or stops, the VRP follows the Travelling Salesman Problem (TSP), in which each of vehicle visiting a set of cities such that every city is visited by exactly one vehicle only once. This work proposes the Ant Colony Optimization (ACO)-TSP algorithm to eliminate the tour loop for Open Vehicle routing Problem (OVRP). A key aspect of this algorithm is to plan the routes of buses that must pick up and deliver the school students from various bus stops on time, especially in the case of far distance covered by the vehicle in a rural area and find out the efficient and safe vehicle route.

**Keywords**—Ant Colony Optimization (ACO); Vehicle routing Problem (VRP); Open Vehicle routing Problem (OVRP); Travelling Salesman Problem (TSP); Swarm Intelligence (SI)

## I. INTRODUCTION

The School Bus Routing Problem (SBRP) is a common real-life problem, proposed in the literature by Newton and Thomas (1969), but has not been tackled that often in the field of computer science. The problem is closely related to the Vehicle Routing Problem (VRP), which has been a popular research area for the last four decades. Vehicle Routing Problem was first described by Dantzig and Ramser (1959), and has been proved NP-hard by Lenstra and Kan (1981). Vehicle Routing Problem (VRP) is a problem which searches the optimal routes that a vehicle travels in order to serve customers residing in a geographically dispersed area. The SBRP has the same characteristics with the Vehicle Routing Problem (VRP) in several ways. While a VRP deals with freight transportation, the SBRP is related to student transportation [1]. Even that now a day many of the organisations are faced with the problem regarding efficient vehicle fleets. When, they need to pick up and deliver items and goods or to provide the pick-up and delivery services to the people. Mainly, in the case of a school transportation system, to service several students with a fleet of vehicles, at morning time pick up from their home location and deliver at central depot school and at evening time pick up from central depot school and deliver to the different home locations of the students on time.

The proposed algorithm consists of two parts; the first part introduces the ACO algorithm with tour loop elimination. The second part describes the comparison study of OVRP and

VRP to find out the most efficient route of buses and to select the bus stops of the vehicle to provide the pick-up and delivery services to the students on time. The study discussed in the paper involves the bus route of Sant Baba Bhag Singh International School situated in rural area in Padhiana, Punjab, India, where more than 1000 students are bussed to the school from different villages and cover up a far distance by the buses, which is the main problem that some buses don't return to the school.

## II. OPEN VEHICLE ROUTING PROBLEM

The Open vehicle routing problem (OVRP) has received in the literature relatively less attention than the VRP. The problem is first described in a paper by Schrage (1981) without any solution attempt. Bodin et al. (1983) address the express airmail distribution in the USA and solve two separate routing problems, one for the delivery and another one for the pick up using a modified Clarke-Wright saving algorithm. The open vehicle routing problem (OVRP) describes efficient routes with minimum total distance and cost for a fleet of vehicles that serve some commodity to a given number of customers. E

ach customer is visited exactly once by one vehicle, while vehicle activity is bounded by capacity constraints, duration constraints and time constraints. Either each route is a sequence of customers who starts at the depot and finishes at one of the customers to whom the goods are delivered, or each route is a sequence of customers who begins at a certain customer and ends at the distribution depot, where goods are gathered. The OVRP differs from the well-known vehicle routing problem (VRP) in that the vehicles do not necessarily return to their original locations after serving to the customers; if they do, they must follow the same path in the reverse order.

The major difference in theory between the OVRP and the VRP is that the routes in the OVRP consist of Hamiltonian paths originating at the depot and ending at one of the customer side, while the routes in the VRP are Hamiltonian cycles. In other words, the best Hamiltonian path is NP-hard, since the Hamiltonian path problem is equivalent to the traveling salesman problem, which is known to be NP-hard.

The best Hamiltonian path problem with a fixed source node must be solved for each vehicle in the OVRP, and OVRP solutions involve finding the best Hamiltonian path for each set of customers assigned to a vehicle. Consequently, the OVRP is also an NP-hard problem.

### III. LITERATURE REVIEW

As mentioned in the introductory section of the paper, the OVRP is an NP-hard combinatorial optimization problem as to deal with OVRP instances of real time and have received in the literature relatively less attention than the VRP. There are several researchers who propose different methods for OVRP and VRP to reduce the distance and cost of the transportation. Marco Dorigo and Luca Maria Gambardella 1997 [2] "Ant Colony System: A Cooperative Learning Approach to the Traveling Salesman Problem," introduces ant colony system (ACS) and presents an intuitive explanation of how ACS works, a distributed algorithm that is applied to the traveling salesman problem (TSP). In ACS, a set of cooperating agents called *ants* cooperate to find good solutions to TSP.

Ants cooperate using an indirect form of communication mediated by pheromone, deposit on the edges of the TSP graph while building solutions. Patrick Schittekat, Marc Sevaux and Kenneth Sorensen 2006 [3] "A mathematical formulation for a school bus routing problem," introduce the school bus routing problem in this paper, is similar to the standard vehicle routing problem. In the standard VRP all stops to visit are given. In our school bus routing problem, we assume that set of potential stops is given, as well as a set of students who can walk to more of these potential stops. The school buses used to pick up the students and transport them to their schools have a finite capacity. The goal of this routing problem is to select a subset of stops that will actually be visited by the buses, determine which stop each student should walk to and develop a set of tours that minimize the total distance travelled by all buses. Jean-Yves Potvin, Ying X, Ilham Benyahia 2006 [4] presents a dynamic vehicle routing and scheduling problem with time windows is described where both real-time customer requests and dynamic travel times are considered. The D Aksen, Z Özyurt and N Aras 2007 [5], consider a variant of the open vehicle routing problem in which vehicles depart from the depot, visit a set of customers and end their routes at special nodes called driver nodes. A driver node can be the home of the driver or a parking lot where the vehicle will stay overnight. AN Letchford, J Lygaard and RW Eglese 2007 [6] also classifies the *open* vehicle routing problems, the vehicles are not required to return to the depot after completing service and they are used the integer programming method based on branch and cut.

Ashek Ahmed, Md. Ali Ahsan Rana, Abul Ahsan Md. Mahmudul Haque, Md. Al Mamun 2008 [7] presents A Multiple Ant Colony Optimization based approach useful to solve dynamic vehicle routing problems with time windows. MACS-DVRPTW is organized with a hierarchy of artificial ant colonies designed to successively optimize a multiple objective function. A.E. Rizzoli, R. Montemanni, E. Lucibello, L.M. Gambardella 2007 [8] presents the applications of ACO to a number of real-world problems: a VRP with time windows for a major supermarket chain in Switzerland; a VRP with pickup and delivery for a leading distribution company in Italy; a time dependent VRP for freight distribution in the city of Padua, Italy, where the travel times depend on the time of the day; and an on-line VRP in the city of Lugano, Switzerland, where customers' orders arrive during the delivery process. Wen-Chen Hu, Naima Kaabouch, Lei Chen,

and Hung-Jen Yang 2011 [9] "Incremental Location Searching for Route Anomaly Detection," presents location-based research, which uses location information to find route anomalies, a common problem of daily life. For example, an alert should be generated when a school bus misses part of a route. Different kinds of route anomalies are discussed and various methods for detecting the anomalies are proposed. The major methods use a technique of incremental location search, which finds matched routes as the search route is entered location by location. An alert is generated when no matched routes exist.

Juan S. Arias-Rojas, José Fernando Jiménez, Jairo R. Montoya-Torres 2012 [10] "Solving of School Bus Routing Problem By Ant Colony Optimization," presents The school bus routing problem (SBRP) seeks to plan an efficient schedule of a fleet of school buses that must pick up students from various bus stops and deliver them by satisfying various constraints. Jianyong Jin, Teodor Gabriel Crainic and Arne Løkketangen 2012 [11] "A parallel multi-neighbourhood cooperative tabu search for capacitated vehicle routing problems" presents a parallel tabu search algorithm that utilizes several different neighbourhood structures for solving the capacitated vehicle routing problem. Single neighbourhood or neighbourhood combinations are encapsulated in tabu search threads and they cooperate through a solution pool for the purpose of exploiting their joint power. P. Schittekat, J. Kinable, K. Sorensen, M. Sevaux, F. Spieksma, J. Springael 2013 [12] presents the paper on understanding the joint problem of bus route generation and bus stop selection, which determine the set of stops to visit, determine for each student which stop, determine for each student which stop. Taehyeong Kim and Bum-Jin Park 2013 [13] "Model and Algorithm for Solving School Bus Problem" presents the model for school bus routing problem is proposed, and a heuristic algorithm for solving the proposed model is suggested. The model is formulated as a mixed-integer programming problem. School bus routing problem has been a significant concern of most people related to school and school bus system as one of the vehicle routing problems. Making an appropriate problem formulation depend on how to reflect the realities of the problem. And, as the problem scope becomes wider, the problem can't be solved only with the exact methods. So, there is a need to develop an efficient heuristic method to solve the more complicated problem. John Awuah Addor, Samuel Kwame Amponsah, Jonathan Annan and Charles Sebil 2013 [14] "School Bus Routing: A Case Study of Wood Bridge School Complex, Sekondi-Takoradi, Ghana," presents a school bus routing problem of wood bridge school complex Sekondi-Takoradi, Ghana. The problem was formulated as an integer programming model and an ant colony based meta-heuristic for the travelling salesman problem was used to solve the problem.

### IV. ACO-TRAVELLING SALESMAN PROBLEM

In the early 1990s, ant colony optimization (ACO) was introduced by M. Dorigo and colleagues as a novel nature-inspired meta-heuristic for the solution of hard combinatorial optimization (CO) problems. ACO belongs to the class of meta-heuristics, which are approximate algorithms used to obtain good enough solutions to hard Combinatorial

Optimization problems in a reasonable amount of computation time [15]. The inspiring source of ACO is the foraging behaviour of real ants. The first ACO algorithm was called the Ant system [16], and it was aimed to solve the travelling salesman problem, in which the goal is to find the shortest round-trip to link a series of cities. These are the popular ways to illustrate the ACO meta-heuristic working through the application of the traveling salesman problem (TSP) [17]. Travelling salesman problem (TSP) consists of finding the shortest route in complete weighted graph G with n nodes and n(n-1) edges; so that the start node and the end node are identical and all other nodes in this tour are visited exactly once. The TSP consists of set of cities is given and the distance among each of them is known.

The goal is to find the shortest tour that allows each city to be visited once and only once. More generally, the goal is to find Hamiltonian tour of minimal length on a fully connected graph (Hamiltonian circuit) [18]. In ant colony optimization, the problem is tackled by simulating a number of artificial ants moving on a graph that encodes the problem itself: each vertex represents a city, and each edge represents a connection between two cities. A variable called pheromone is associated with each edge and can be read and modified by ants. The most popular practical application of TSP is a regular distribution of goods or resources, finding of the shortest of customer servicing route, planning bus lines, etc., but also in the areas that have nothing to do with travel routes [19]. The Moving of ant depends on the amount of pheromone updating on the graph edges and the transition probability  $p_{ij}^k(t)$  of a virtual ant from the node i to j is given by the formula [16]:

$$p_{ij}^k(t) = \begin{cases} \frac{[\tau_{ij}(t)]^\alpha \cdot [\eta_{ij}]^\beta}{\sum_{k \in \text{allowed}_k} [\tau_{ij}(t)]^\alpha \cdot [\eta_{ij}]^\beta} & \text{if } j \in \text{allowed}_k \\ 0 & \text{otherwise} \end{cases} \quad (1)$$

Where,  $\tau_{ij}$  represents the pheromone trail,  $\eta_{ij}$  is the inverse distance, the parameters  $\alpha$  and  $\beta$  control the balance to which ants follow the closest cities and the strongest pheromone trails.

#### A. Proposed ant colony algorithm (aco) for ovrp

This algorithm proposes the ACO tour loop elimination, which is further used to describe the Open vehicle routing problem. Loop elimination can be done by iteratively scanning the node identifiers position by position from node (i to j) and node (j to i) and pictorial dataset are used in the form of map images to mark up the nodes or stops of vehicles. We can plan the vehicle fleet through using an ant colony optimization algorithm by formulating the problem in the form of TSP model for OVRP.

Given a set of n cities (stops), ACO-TSP for OVRP can be stated as the problem of finding a minimal lengthly open tour that visits each city once. An instance of TSP can be represented by a graph  $G=(V,E)$  where V is the set of nodes, and E is the set of arcs in the graph. Each node represents a stop in which students (customers in the classical VRP) have to be serviced, while an arc corresponds to the route to go

from node i to j. We call  $d_{ij}$  the length of a path between city i and j,  $d_{ij}$  can be defined in the Euclidean space and is given as follows:

$$d_{ij} = \sqrt{[(x_i - x_j)^2 + (y_i - y_j)^2]} \quad (2)$$

Let  $a_i(t)$  (i= starting point + intermediate point + end point) be the number of ants in city i at time t and let  $m = \sum_{i=1}^n S_i(t) + \sum_{i=1}^n E_i(t) \sum_{i=1}^n I_i(t)$  be the total number of ants. Where to start point ( $S_i$ ) represents source city and end point ( $E_i$ ) represents destination city, which are identical (value is always 1). Intermediate Point ( $I_i$ ) represents the cities between  $S_i$  and  $E_i$  i.e. (Total cities- $S_i$ - $E_i$ ).

#### B. ACO based solution to eliminate tour loop

- 1) Initialize: To mark up the cities according to  $a_i(t)(i)$ .
- 2) Set the parameters:  $t=0$  {t is the time counter} and  $NC=0$  {NC is the cycle counter of iterations}
- 3) To set the Trail value  $\Delta \tau_{ij}=c$  for trail intensity and  $\Delta \tau_{ij}=0$ .
- 4) Set  $z=1$  {z is the tabu list index}  
For  $k=1$  to m do  
Store the source city of k-th ant in  $\text{tabu}_k(z)$
- 5) Repeat until tabu list is full and repeated upto(n-1) times  
Set  $z=z+1$   
For  $k=1$  to m do  
Choose the next city j to move with probability according to equation (1)  
Then move the the k-th ant to the next city j and update city j in tabu list
- 6) For  $k=1$  to m do  
Move the k-th ant from  $\text{tabu}_k(n)$  to  $\text{tabu}_k(1)$
- 7) Initialize the tour:  
For  $ic=1$  to n-ants, where ic is number of cities  
Tour (i) =tour (1 to n-2)  
Update  $\text{tabu}(n-1)$  to  $\text{tabu}(2)$   
Tour=Tour+2  
Tour (n-ants) =2  
Tour (2, n-1) =Tour (1 to n-2)  
Tour (1) =1  
Update the shortest tour found
- 8) Pheromone update on every edge(i,j) for  $k=1$  to m, according to the following equation:  
$$\Delta \tau_{ij}^k = \begin{cases} Q/L_k & \text{if } (i,j) \in \text{tour described by } \text{tabu}_k \\ 0 & \text{otherwise} \end{cases}$$
  
$$\Delta \tau_{ij} = \Delta \tau_{ij} + \Delta \tau_{ij}^k$$
- 9) For every edge (i,j) compute  $\tau_{ij}(t+n)$  according to equation:  $\tau_{ij}(t+n) = \rho \cdot \tau_{ij}(t) + \Delta \tau_{ij}$   
Set  $t=t+n$   
Set  $NC=NC+1$   
For every edge(i,j) set  $\Delta \tau_{ij}=0$
- 10) If NC greater than assign value



```

then
    Empty the all tabu lists
    GOTO Step 4
else
    Print shortest tour
    Stop
    
```

### V. SIMULATION RESULTS

The algorithm is coded in MATLAB-2011b to achieve the computational optimize results. The results are described in two cases: Case-I describe the ACO tour loop elimination and in Case-II, analyses the path selection and stops/nodes selection behaviour of the two different ACO algorithms-one with tour cycle and others with tour loop elimination. To describe the results of the proposed algorithm or to show up the ACO tour loop elimination, the algorithm is tested by using the dataset in the form of as map images. In map images, the user has to select the stops by pointing them wherever required. The three types of points are given-red, green and black. Where, red point describes the starting/source position of the bus; green point describes the different stops of bus, and black point describes the end/destination position of the bus.

In the ACO, ant colony system with tour loop elimination is used to evaluate the result, a value for each parameter is:  $\alpha=2$ ,  $\beta=6$ ,  $\rho=0.5$ ,  $Q=2.7179$  and select the number of ants equal to the number of bus stops(including red and black point).

#### A. Case-I:

The result of algorithm ACO-tour loop elimination as shown in Fig.1, where a number of stops and number of ants are 21 and iterations=1000 and the final open route is:

1→3→4→5→6→7→8→9→10→11→12→13→14→15→16→17→18→19→20→21→2

Point 1 (red) represents the starting/source position, and point 2 (black) represents the end/destination position of the vehicle.

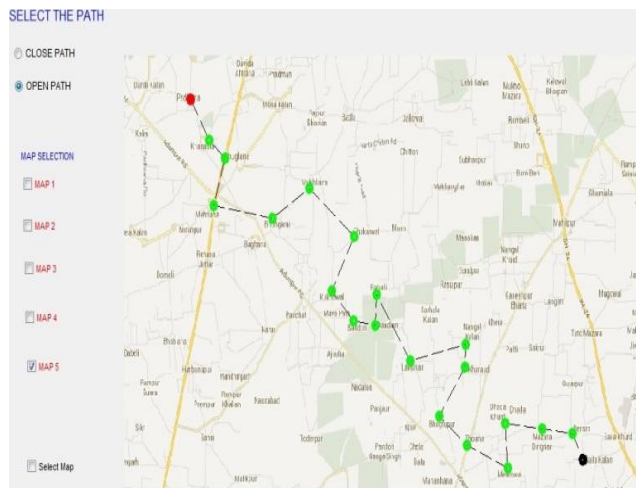

Fig. 1. shows the route map of ACO tour loop elimination

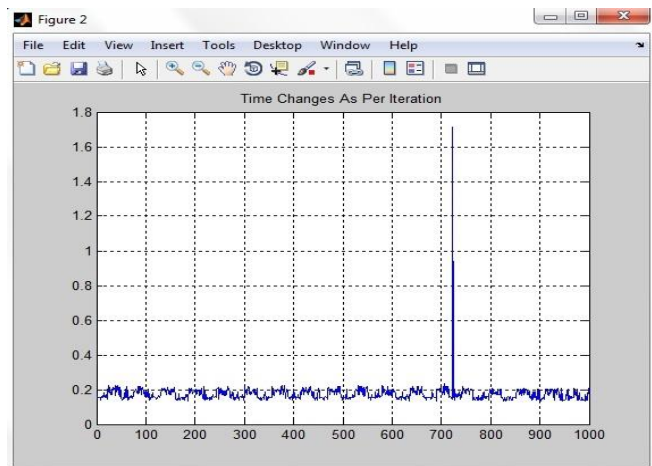

Fig. 2. shows the time changes as per iteration

#### B. Case-II:

The computational results of the ACO algorithm-one with tour cycle and others with tour loop elimination obtained are shown in Table 1.

TABLE I. ACO RESULT

	ACO Result	
	Existing ACO Algorithm	Proposed ACO Algorithm (Tour Loop Elimination)
Computational Distance (miles)	1833.2729	1329.8818
Computational Time (millisecond)	0.201	0.147
No. of Iterations	5000	1000
Tour length	18→17→16→15→14→ 19→20→10→11→12→ 13→7→9→8→21→4→ 3→2→1→6→5→18	1→3→4→5→6→7→ 8→9→10→11→12→ 13→14→15→16→17→ 18→19→20→21→2
No. of ants	21	21
Q	2.7179	2.7179
$\alpha$	2	2
$\beta$	6	6
$\rho$	0.5	0.5

We can reach a summing-up to select the bus route, which one is the best either close path or open path by comparing the data in Table 1 and Fig. 3 and fig. 5, which shows the optimal solution for path selection to provide the pick-up and delivery services to the students. In fig. 5, it is depicted that some destinations are near to the school and some are far. However, the students belonging to an area which is away from school, reach their home earlier than the near ones. Fig. 3 gives solution to the problem. Fig. 3 also depicts that there is one feature, if end/destination position selected by the user is not accurate, then it'll finalize by the method. All of these show that this method can be a better way to find out the efficient vehicle route in case of far distance covered by the vehicle.

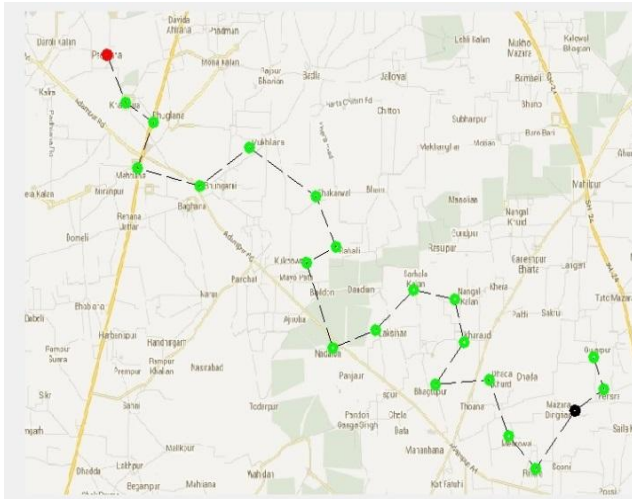

Fig. 3. Shows the open tour length

1→3→4→5→6→7→8→9→10→11→12→13→14→15→16→17→18→19→20→21→2

Point 1 (red) represents the starting/source position and point 2 (black) represents the end/destination position of the vehicle.

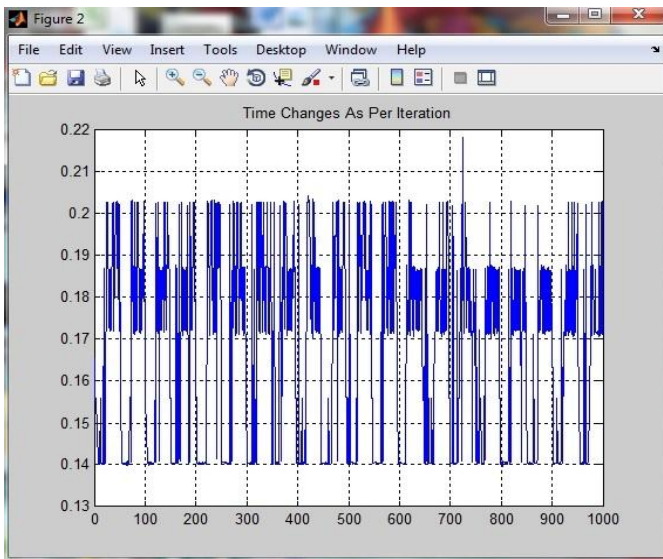

Fig. 4. shows the time changes as per iteration

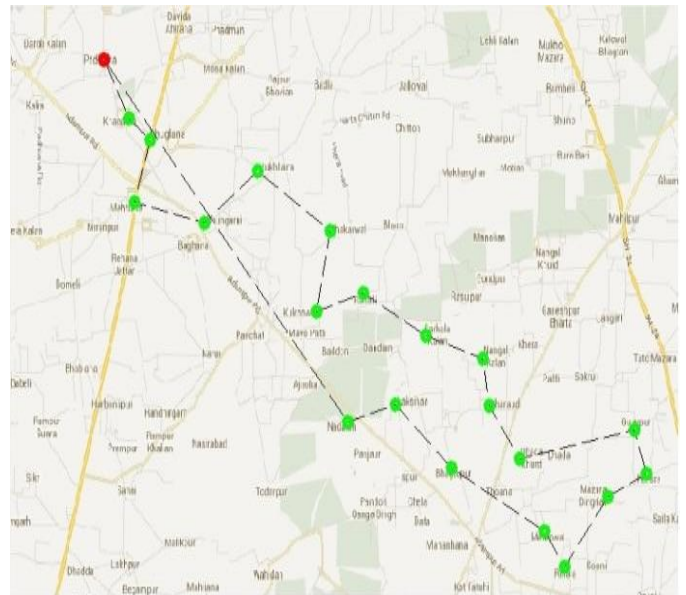

Fig. 5. shows the close tour length

18→17→16→15→14→19→20→10→11→12→13→7→9→8→21→4→3→2→1→6→5→18

Point 18 (red) represents the source and destination position of vehicle.

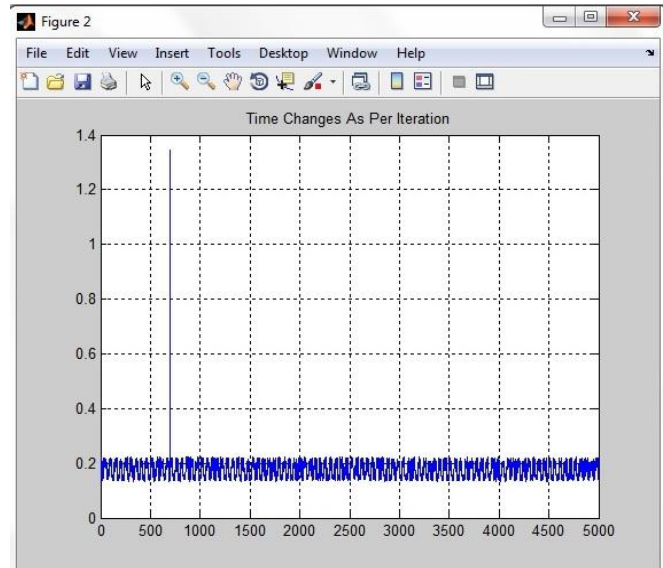

Fig. 6. shows the time changes as per iteration

## VI. CONCLUSION AND FUTURE SCOPE

This paper presents an approach for solving open vehicle routing problem for school buses based on an ant colony algorithm. The proposed method is not only used to plan the close and open routes of school buses and transporter decide that which route is best to pick up and deliver the students to their home but also reduce the total distance and running of the vehicle, which further effect the transportation and operational cost of the vehicle. Computed result shows that for

far distance; open route is best as compared to close route. Further research is to add additional feature in the proposed method to implement the ACO algorithm with navigation system, to achieve the exact route with exact timing. So, this method can be practically applied in real life.

#### REFERENCES

- [1] Kristof Van Moffaert, Bert Van Vreckem, MihailMihaylov and Ann Now'e" A Learning Approach to the School Bus Routing Problem", Proceedings of the 23rd Benelux Conference on Artificial Intelligence, pp.280 – 288.
- [2] Marco Dorigo and Luca Maria Gambardella "Ant Colony System: A Cooperative Learning Approach to the Traveling Salesman Problem", publication in the IEEE Transactions on Evolutionary Computation, Vol.1, No.1, 1997.
- [3] Patrick Schittekat, Marc Sevaux, Kenneth Sirensen " A mathematical formulation for a school bus routing problem" 'I -4244-0451-7/06/2006, IEEE.
- [4] Jean-Yves Potvin, Ying Xu, Ilham Benyahia "Vehicle routing and scheduling with dynamic travel times", Computers & Operations Research 33 (2006) 1129–1137, Science Direct, Elsevier.
- [5] D AksenI, Z Özyurt and N Aras "The open vehicle routing problem with driver nodes and time deadlines" Correspondence: Necati Aras, Boğaziçi University, Department of Industrial Engineering, Bebek, 34342 İstanbul, Turkey.
- [6] AN.Letchford, J Lysgaard and RW Eglese "A branch-and-cut algorithm for the capacitated open vehicle routing problem", Journal of the Operational Research Society (2007) 58, 1642 –1651.
- [7] AshekAhmmed, Md. Ali Ahsan Rana, Abul Ahsan Md. MahmudulHaque, Md. Al Mamun "A Multiple Ant Colony System for Dynamic Vehicle Routing Problem with Time Window", Third 2008 International Conference on Convergence and Hybrid Information Technology.
- [8] A.E. Rizzoli, R. Montemanni, E. Lucibello , L.M. Gambardella "Ant colony optimization for real-world vehicle routing problems-From theory to applications", Swarm Intell (2007) 1: 135–151 and Published online: 13 September 2007 © Springer Science + Business Media, LLC 2007.
- [9] Wen-Chen Hu, Naima Kaabouch, Lei Chen, and Hung-Jen Yang 2011" Incremental Location Searching for Route Anomaly Detection", published in 2011 IEEE International Conference on Electro/Information Technology.
- [10] Juan S. Arias-Rojas, José Fernando Jiménez, Jairo R. Montoya-Torres "SOLVING OF SCHOOL BUS ROUTING PROBLEM BY ANT COLONY OPTIMIZATION" Revista EIA, ISSN 1794-1237 Número 17, p. 193-208. July 2012, Escuela de Ingeniería de Antioquia, Medellín (Colombia).
- [11] JianyongJin, Teodor Gabriel Crainic and Arne Løkketangen "A parallel multi-neighborhood cooperative tabu search for capacitated vehicle routing problems", European Journal of Operational Research 222 (2012) 441–451.
- [12] Schittekat, P., Kinable, J., Sörensen, K., Sevaux, M., Spieksma, F., Springael, J., A metaheuristic for the school bus routing problem with bus stop selection, European Journal of Operational Research (2013).
- [13] Taehyeong Kim and Bum-Jin Park 2013" Model and Algorithm for Solving School Bus Problem", published in Journal of Emerging Trends in Computing and Information Sciences, Vol. 4, No. 8 August 2013, ISSN 2079-8407.
- [14] John AwuahAddor, Samuel Kwame Amponsah, Jonathan Annan and Charles Sebil 2013 "School Bus Routing: A Case Study of Wood Bridge School Complex, Sekondi-Takoradi, Ghana", published in International Journal of Business and Social Research (IJBSR), Volume -3, No.-12, December, 2013.
- [15] Marco Dorigo, Christian Blum "Ant colony optimization theory: A survey", Theoretical Computer Science 344 (2005) 243 – 278, Science Direct and Elsevier.
- [16] Marco Dorigo, VittorioManiezzo and Alberto Coloni "The Ant System: Optimization by a colony of cooperating agents", IEEE Transactions on Systems, Man, and Cybernetics–Part B, Vol.26, No.1, 1996, pp.1-13.
- [17] Marco Dorigo and Krzysztof Socha "An Introduction to Ant Colony Optimization", IRIDIA-Technical Report Series Technical Report No.TR/IRIDIA/2006-010, ISSN 1781-3794.
- [18] Marco Dorigo, Mauro Birattari, and Thomas Stutzle "Ant Colony Optimization-Artificial Ants as a computational Intelligence Technique", IEEE COMPUTATIONAL INTELLIGENCE MAGAZINE, NOVEMBER 2006.
- [19] Ivan Brezina Jr, ZuzanaČičková "Solving the Travelling Salesman Problem Using the Ant Colony Optimization", Management Information Systems, Vol. 6, 4/2011, pp. 010-014.

# Feasibility of automated detection of HONcode conformity for health-related websites

Célia Boyer, Ljiljana Dolamic  
Health On the Net Foundation  
Geneva, Switzerland

**Abstract**—In this paper, authors evaluate machine learning algorithms to detect the trustworthiness of a website according to HONcode criteria of conduct (detailed in paper). To derive a baseline, we evaluated a Naive Bayes algorithm, using single words as features. We compared the baseline algorithm's performance to that of the same algorithm employing different feature types, and to the SVM algorithm. The results demonstrate that the most basic configuration (Naive Bayes, single word) could produce a 0.94 precision for “easy” HON criteria such as “Date”. Conversely, for more difficult HON criteria “Justifiability”, we obtained precision of 0.68 by adjusting the system parameters such as algorithm (SVM) and feature types (W2).

**Keywords**—internet content quality; health; machine learning

## I. INTRODUCTION

Should I trust the medical information on an internet-based web page? Has it been written by a medical professional? Is the information up to date? Web users should ask these questions when accessing online health information. The Health on the Net Foundation (HON) addresses these issues by way of its certification program, the HON Code of Conduct (HONcode). The HONcode, launched in 1995 (HONcode,[9]) is a set of ethical principles defined by the HON Foundation with a consensus of health information editors in order to assess the quality of on-line health information. Currently, it is the oldest, most renowned and the most utilized quality code for online health information, with more than 8'300 certified health websites worldwide. Since 1996 HON has been working with Internet health editors as well as patients to guide web users to trustworthy health information.

The HONcode certification involves manual reviews that examine the processes used in creating and maintaining health-related websites. HON does not validate a site's content, per se.

The HONcode criteria used for certification are (see details at <http://www.healthonnet.org/HONcode/Conduct.html>):

- Authoritativeness
- Complementarity
- Privacy protection
- Attribution
- Justifiability
- Transparency

- Financial disclosure
- Advertising policy

Given the overwhelming quantity of medical information currently available, internet users, such as patients, have difficulty finding information they judge to be trustworthy [1], [2]. The goal of HONcode certification is to enable patients to more easily distinguish websites that adhere to quality standards just by looking for the HONcode quality seal. Websites displaying this seal conform to the quality guidelines of the HONcode. Due to the ever-increasing number of health websites, reviews for HONcode certification now only occur when a site's webmaster requests such a review. This means that absence of the HONcode seal does not absolutely preclude a site from meeting HONcode criteria.

About 80% of searches carried out for health information start from a general search engine [3] that admixes quality health information with manipulated, biased or misleading health content in its displayed results [4]. Up to 35% of US adults used the Internet and did not visit a clinician to get a professional opinion [3] and only 41% of online diagnoses say a medical professional confirmed their online diagnosis. The ability to find credible information has a direct impact on the health of the public ([5]; [6]). Trust and quality are concepts that are difficult to define; [7] gives a rather exhaustive outline of what is trust on the Internet and within the context of the Semantic Web. Over 19 different factors have been listed as components of trust for websites [8].

Our goal in this study was to evaluate the feasibility of automatic detection of the eight HONcode quality principles. This is the goal of HON's research conducted within the European project KHRESMOI (2010-2014, project No. 257528). KHRESMOI helps to guide the general public to reach health websites which are HON certified or are otherwise selected based upon an automated system identifying the principles disclosed in a site.

The rest of this document is organised as follows; next section gives the insight to related work, the methods used in the experiments are described in the section III. The results are given in the section IV. Finally, Section V brings the conclusion and future work guidelines are given in the Section VI.

## II. RELATED WORK

Most previous studies performed related to trust on the internet have focused on the e-commerce domain for which



certain criteria have been determined [16]. Despite the volume of research available in this domain, there remains a lack of basic consensus about the meaning of trust. The same problem exists in the domain of online health sites. To our knowledge, most studies of health-related trust have only tested individual specific points defined by a project [17][18]. The lack of a de facto comprehensive standard for trust of online health information precludes comparison among different studies.

The HONcode standard of conduct, establishes a process-based standard for trust of health information. This manual process requires large amounts of time and human resources. For this reason, automation of this process has become an important issue. In this effort a study has been conducted at HON in this purpose [10]. In this study, the extracts were separated into sentences which were then used as documents. As a result, the incorrect class attribution has occurred during the collection creation, since not each sentence conforms to a criterion if the document as whole does.

### III. METHODS

#### A. Collection acquisition

While HONcode certification process is performed for websites written in multiple languages. However the studies performed here were limited to those written in the English language only, since the data for this language is considered to be the most complete one. Table I gives the number of extracts per criteria available for this language

Unlike the previous studies conducted by HON in the domain of automatic detection of the HONcode principles [10], in this research we used the whole document as the classification unit. Indeed the statement about a certain criterion is spread within the whole document, and not concentrated into a single sentence, making the document a more suitable classification unit than sentences.

TABLE I. NUMBER OF EXTRACTS PER HONCODE CRITERIA

Criteria	Number of extracts
Authority	2812
Complementarity	2835
Privacy	2683
Reference	2349
Justifiability	872
Transparency	2861
Financial disclosure	2700
Advertising policy	1412
Date	2794

The authors created a database containing positive and negative examples of compliance with the eight HONcode principles. Human experts were asked to extract the text demonstrating whether a given website conformed to each HONcode criterion. Establishing negative examples was not possible, per se. What would comprise a negative example of privacy policy other than its mere absence? Therefore, the documents supporting other HON criteria were used as negatives for the criteria other than their targets. We divided the principle Attribution into two criteria: Reference and Date due to different requirements for these two elements. Each

extract obtained in this manner represents one document within the training/test collection.

Documents could conform to support more than one criterion, so we classified the text into categories that were not mutually exclusive (any-of *classification*). If a document conformed to one criterion, it did not imply that it conformed (or did not conform) to any other. We took an approach described in [11]:

- Build a classifier for each class, where the training set consists of the set of documents in the class (positive labels) and its complement (negative labels).
- Given the test document, apply each classifier separately. The decision of one classifier has no influence on the decisions of the other classifiers.

We ran all the experiments using 10-fold cross-validation.

#### B. Machine learning algorithms

We used the machine learning algorithms described in the learning framework [12]: Naive Bayes (NB) and C\_SVC Support Vector Machines with radial kernel (named in this document SVM).

We used the C\_SVC SVM as it is the less time consuming compared to other SVMs. We applied the NB and the SVM using various features types, using different feature reductions levels.

#### C. Features

We pre-treated the documents linguistically, removing stop words and applying Porter stemming. The learning unit was then set to one of the following, to best identify which features suited the principle being automatically extracted:

- single word (W1) - “privacy information” → “privat”, “inform”
- two conjunct words (W2) - “privacy information” → “privat\_inform”
- word co-occurrence (COOC) - “privacy information” or “information about privacy” → “privat\_inform”

We chose the single word W1 (bag of words) for the baseline of this study. W2 and COOC differ in that W2 takes into account the word order, while COOC does not.

#### D. Feature selection

Feature selection has two goals, first reducing the dimension of the document representation and second distinguishing features that help to determine a document’s class. The latter reduced over fitting, making sure that the model is not too general.

We used document frequency for feature selection, as it is simple and effective. It uses only the features whose document frequency exceeds a predefined threshold (after stop word removal).

We used various levels of features reduction, keeping 30%, 50% or 80% of features with a goal of demonstrating how the

reduction of the number of features would influence classifier performance.

TABLE II. PRECISION, RECALL AND F1-MEASURE AVERAGE OF 10 RUNS FOR AUTHORITY, COMPLEMENTARITY, PRIVACY PRINCIPLES

Parameters			Criteria								
Algorithm (Alg.)	Feature Type (FT)	% FT Kept	Authority			Complementarity			Privacy		
			Precision	Recall	F1	Precision	Recall	F1	Precision	Recall	F1
NB	W1	80	0.50	0.85	0.63	0.84	0.95	0.89	0.69	0.98	0.81
NB	W1	50	0.50	0.86	0.63	0.83	0.95	0.89	0.69	0.98	0.81
NB	W1	30	0.50	0.87	0.63	0.83	0.95	0.89	0.70	0.98	0.82
NB	W2	30	0.52	<b>0.88</b>	0.65	0.84	0.96	0.90	0.85	0.98	0.91
NB	COOC	30	0.51	0.84	0.63	0.78	<b>0.97</b>	0.86	0.80	<b>0.99</b>	0.88
SVM	W1	30	0.70	0.64	0.67	0.89	0.91	0.90	0.96	0.97	0.97
SVM	COOC	30	0.66	0.56	0.60	0.89	0.89	0.89	0.97	0.94	0.95
SVM	W2	30	<b>0.73</b>	0.69	<b>0.71</b>	<b>0.92</b>	0.91	<b>0.92</b>	<b>0.97</b>	0.97	<b>0.97</b>

TABLE III. PRECISION, RECALL AND F1-MEASURE AVERAGE OF 10 RUNS FOR REFERENCES, JUSTIFIABILITY, TRANSPARENCY PRINCIPLES

Parameters			Criteria								
Algorithm (Alg.)	Feature Type (FT)	% FT Kept	References			Justifiability			Transparency		
			Precision	Recall	F1	Precision	Recall	F1	Precision	Recall	F1
NB	W1	80	0.43	0.77	0.55	0.49	0.50	0.50	0.86	0.95	0.90
NB	W1	50	0.41	0.79	0.54	0.45	0.59	0.51	0.85	0.96	0.90
NB	W1	30	0.40	<b>0.81</b>	0.54	0.40	<b>0.65</b>	0.50	0.85	<b>0.97</b>	0.90
NB	W2	30	0.43	0.81	0.56	<b>0.69</b>	0.58	<b>0.63</b>	0.90	0.97	0.93
NB	COOC	30	0.41	0.73	0.53	0.39	0.53	0.45	0.73	0.90	0.81
SVM	W1	30	0.61	0.60	0.61	0.52	0.53	0.52	0.94	0.95	0.95
SVM	COOC	30	0.51	0.41	0.46	0.41	0.33	0.36	0.85	0.81	0.83
SVM	W2	30	<b>0.65</b>	0.64	<b>0.64</b>	0.61	0.56	0.58	<b>0.95</b>	0.96	<b>0.96</b>

TABLE IV. PRECISION, RECALL AND F1-MEASURE AVERAGE OF 10 RUNS FOR FINANCIAL, ADVERTISING, DATE PRINCIPLES

Parameters			Criteria								
Algorithm (Alg.)	Feature Type (FT)	% FT Kept	Financial			Advertising			Date		
			P	R	F1	P	R	F1	P	R	F1
NB	W1	80	0.57	0.92	0.71	0.60	0.85	0.70	0.94	0.94	0.94
NB	W1	50	0.56	0.94	0.70	0.54	0.91	0.68	0.94	0.95	0.94
NB	W1	30	0.56	<b>0.94</b>	0.70	0.51	<b>0.94</b>	0.66	0.94	0.95	0.95
NB	W2	30	0.57	0.92	0.71	0.66	0.87	0.75	0.95	0.97	0.96
NB	COOC	30	0.54	0.90	0.67	0.50	0.83	0.63	0.79	0.89	0.84
SVM	W1	30	0.79	0.79	0.79	0.74	0.80	0.77	0.95	0.95	0.95
SVM	COOC	30	0.78	0.69	0.73	0.65	0.72	0.68	0.91	0.81	0.86

SVM	W2	30	<b>0.84</b>	0.81	<b>0.82</b>	<b>0.77</b>	0.81	<b>0.79</b>	<b>0.96</b>	<b>0.97</b>	<b>0.96</b>
-----	----	----	-------------	------	-------------	-------------	------	-------------	-------------	-------------	-------------

#### IV. RESULTS

Here are the examples of the extracts from certified websites taken by the experts for two criteria (transformed into lower case):

- Complementarity: “the information that we provide on our web site is designed to support, not replace, the relationship that exists between a patient/site visitor and his/her physician. Please keep in mind that the text provided is for informational purposes only and is not a substitute for professional medical advice, examination diagnosis or treatment. Always seek the advice of your physician or other qualified health professional before starting any new treatment or making any changes to existing treatment.”
- Privacy: “privacy policy this web site does not collect information from any visitor. Cookies are not used at any time. we do not collect email addresses and any communication will not result in the retention of your information in any form. We do not keep a database of visitor information or any other statistics regarding the demographics or other attributes of users of this web site. There are opportunities to become a patient of the norman endocrine surgery clinic, however, this occurs on two specific pages designed for this purpose. These two pages are hosted on a secure server. You will know that you are entering your data and warnings will be given. This is a clear decision that you will make. These two pages are encrypted and secure and are clearly marked as such. These two pages have the logos and secure certificates clearly visible. The information entered on these two secure pages is not accessible to anybody except the medical staff of the norman endocrine surgery clinic. These two secure pages have been approved and meet all current 2004 standards for secure online medical information as established by the american medical association.”

Tables II, III and IV presented in this section give the results obtained for different combinations of parameters (algorithm (Alg.), feature type(FT), percentage of features kept(Kept%)) described above.

We expressed the results using standard measurements: precision (P), recall(R) and F-measure(F). Precision represents the fraction of all documents assigned to given class by the classifier that really belong to that class, while recall represents the fraction of all documents that belong to the given class according to the test set that were correctly assigned by the classifier. The F-measure is the harmonic mean of P and R.

In Tables II, III and IV the best performance in precision recall and F-measure is given in bold.

The cells in grey show a precision up to 73 % for an F1 measure of up to 71% for all the criteria except for the criteria “References” and “Justifiability” where respectively the precision is 65% and 69% for an F1-measure of 64% and 63% respectively. The automatic classification for the Transparency, Complementarity, Privacy, and Date criteria show a precision

over 92% with a good recall over 91%. Authority, Funding and Advertising are above of 73% of precision and a recall up to 69%

##### A. Effect of the algorithm used

Even though the performance difference between these two algorithms in the study can go up to 53% (“References”, W1) higher precision using SVM rather than NB, for certain criteria (Complementarity, Transparency, Date) this difference never exceeds 15%.

##### B. Effect of feature type

As it can be noticed from the tables, the choice of the feature type impacted on the classifier performance. In certain cases, as for example the criteria Justifiability, changing the feature type from W1 to W2 with the same feature reduction level leads to relative increase in precision by more than 50%. The W2 and COOC seem to be performing similarly in the most of the cases, although for certain criteria such as Transparency or Justifiability the precision with COOC is much smaller. This is probably the result of the COOC unlike W2 takes no context into account.

##### C. Effect of reducing feature space

The size of the term space can be significantly reduced without significant loss in the performance of the text classifier. This is the main goal of the features selection process. We chose Naive Bayes, with W1 setting to illustrate the impact of this parameter on the classification results. ]

The first three lines in Tables 2, 3 and 4 indicate that difference in the precision is rather small between the 80%, 50% and 30% features kept. The relative decrease in precision of 18,7% between the 80% features kept (0.49, taken as a baseline) and 30% (0.40) features kept for the criteria “Justifiability” given in the Table 3 is the only difference that can be seen as important . On the other hand, it is noticeable for this criterion that the recall in the case of 80% features kept is only at 50%, making the classification rather random.

#### V. DISCUSSION / CONCLUSION

In our previous studies conducted by HON in the domain of automatic detection of the HONcode principles [10] we conducted a preliminary feasibility study of the design and the evaluation of an automatic system conceived for the categorization of medical and health documents according to the HONcode ethical principles. Based on our first promising results, the research activities presented in this paper is a prospective validation study where the classifiers has been tuned, features has been evaluated, the corpus has changed and the classifier examined previously unexplored websites.

In the previous study the sentences was used as the unit for the classification. Here we use the document as a unit for classification in order to avoid false positive in the collection creation since each single sentence is not necessary conforming to the criteria if the document itself is.

Based on the article [20] the agreement of the manual classification between two persons rarely gives more than 72% of precision. The automatic classification globally largely outperforms what we can expect from a manual classification.



We used Document Frequency as an algorithm for features selection. It has been shown that the feature space can be reduced by 70% without an important loss in performance.

The results obtained also show, that for a certain number of criteria, we can denominate these criteria as “easy” and even the most “simple” parameter setup returns very good results in precision. We can take the criteria Date, Complementarity or Transparency as examples of “easy” criteria. For the NB, W1, 30% parameter combination precision obtained for these criteria are 0.94, 0.83 and 0.85 respectfully.

Ever since the first work carried out to apply the SVM on text categorization [12], [13] it has proven to be more effective than other baselines. The SVM used in our study gives higher results in terms of precision than the Naive Bayes algorithm for most HONcode criteria, with exception of the “Justifiability” were NB seems to perform better in terms of precision.

However if we take into account the time/resource consumption difference between the two algorithms presented in this paper, this proves that, even though being less efficient, the usage of the NB is still justifiable.

It has also been shown that even with a simple feature selection such as Document Frequency and different learning algorithms and features types it is possible to achieve precision of more than 70%, with the exception of the References and Justifiability criteria.

## VI. FUTURE WORK

The next steps in our study is to implement and investigate other feature selection algorithms, feature weighting (such as tf-idf [15]) and feature types (ex. character or word n-gram) in order to achieve over 85% of precision for all the HONcode principles including those estimated to be “hard “to automatically retrieved in this study.

We will need to face the automatic system to the manual one. So the next work will be to then have manual HONcode experts to review the results of the automatic classifier to determine accuracy and precision in practice.

Another important problem concerning health related information on the web is the presence of fake websites addressed in [19]. Current concept of the HONcode doesn't deal directly with the quality of the website content. The question that one might ask is: “What if a website complies to all HONcode principles but with a content of a very bad quality?” We will explore two techniques, based on external knowledge, to enhance the performance of the evaluation algorithm.

### A. Accessing scientific information

An alternative or a complementary element to automatic detection of the references in health website could be the usage of the MEDLINE database (via pubmed) for identifying the outcome for a given field and compare it with the content of the given page.

### B. Incorporating an algorithm for the automatic detection of fake websites

Some websites copy contents from other website with no added value; their only purpose is to attract advertising. Algorithms have been developed to detect these sites.

We will design a way to incorporate them into our detection algorithm and test if they bring some performance improvement.

Finally the automatic classifier should be implemented and integrated into real system to assess the usage by HONcode reviewers or by Internet searchers.

## REFERENCES

- [1] Wong LM, Yan H, and al. 'urologists in cyberspace: A review of the quality of health information from american urologists' websites using three validated tools. *Can Urol Assoc J.*, 7(3-4):100–107, 2013.
- [2] Carrion, Fernandez, and Toval. Are personal health records safe? a review of free web- accessible personal health record privacy policies. *Jmir*, 14(4), 2012.
- [3] Pew Internet & American Life Project - 2013 report
- [4] P. López-Jornet, F. Camacho-Alonso The quality of Internet sites providing information relating to oral cancer, *Oral Oncology*, 2009
- [5] van Straten, A., Cuijpers, P., & Smits, N. (2008). Effectiveness of a Web-Based Self-Help Intervention for Symptoms of Depression, Anxiety, and Stress: Randomized Controlled Trial. *Journal of Medical Internet Research*, 10(1), e7
- Humphrey, T. (2009, December 23). Internet Users Now Spending an Average of 13 Hours a Week Online at <http://news.harrisinteractive.com/profiles/investor/ResLibraryView.asp?BzID=1963>; accessed on January 8, 2012.
- [6] Artz D., Gil Y (2007) A survey of trust in computer science and the Semantic Web. *Web Semantics: Science, Services and Agents on the World*, 2007.
- [7] Gil Y., Artz D.: Towards content trust of web resources, *Web Semantics: Science, Services and Agents on the World Wide Web* Volume 5, Issue 4, *World Wide Web Conference 2006 Semantic Web Track*, December 2007, Pages 227-239.
- [8] Boyer C., Baujard V., Scherrer J (1999): HONcode: a standard to improve the quality of medical/health information on the internet and HON's 5th survey on the use of internet for medical and health purposes. In 6th Internet World Congress for Biomedical Sciences (INABIS 2000), 1999.
- [9] Arnaud Gaudinat, Natalia Grabar, and Celia Boyer. Machine learning approach for automatic quality criteria detection of health web pages. In Klaus A. Kuhn, James R. Warren, and Tze-Yun Leong, editors, *MedInfo*, volume 129 of *Studies in Health Technology and Informatics*, pages 705–709. IOS Press, 2007.
- [10] Christopher D. Manning, Prabhakar Raghavan, and Hinrich Schütze. *Introduction to information retrieval*. Cambridge University Press, 2008.
- [11] K. Williams and RA. Calvo. A framework for document categorization. 7th Australian document computing symposium, 2002.
- [12] Susan Dumais, John Platt, David Heckerman, and Mehran Sahami. 1998. Inductive learning algorithms and representations for text categorization. In *Proceedings of the seventh international conference on Information and knowledge management (CIKM '98)*, K. Makki and L. Bouganim (Eds.). ACM, New York, NY, USA, 148-155. DOI=10.1145/288627.288651 <http://doi.acm.org/10.1145/288627.288651>
- [13] Thorsten Joachims. 1999. Making large-scale support vector machine learning practical. In *Advances in kernel methods*, Bernhard Schölkopf, Christopher J. C. Burges, and Alexander J. Smola (Eds.). MIT Press, Cambridge, MA, USA 169-184.
- [14] Ricardo A. Baeza-Yates and Berthier Ribeiro-Neto. 1999. *Modern Information Retrieval*. Addison-Wesley Longman Publishing Co., Inc.,

- Boston, MA, USA.[16] Ardion Beldad, Menno de Jong, and Michaël F. How shall I trust the faceless and the intangible? A literature review on the antecedents of online trust. Steehouder. *Computers in Human Behavior* 26(5):857-869 (2010)
- [15] Gunther Eysenbach, John Powell, Oliver Kuss, and Eun-Ryoung Sa. Empirical Studies Assessing the Quality of Health Information for Consumers on the World Wide Web -- A Systematic Review *Journal of the American Medical Association JAMA* 287(20):2691—2700 (May 2002)
- [16] Sillence, E., Briggs, P., Harris, P.R. and Fishwick, L. (2007) How do patients evaluate and make use of online health information? *Social Science and Medicine*, 64 (9). pp. 1853-1862. ISSN 0277-9536
- [17] Ahmed Abbasi, Fatemeh "Mariam" Zahedi, and Siddharth Kaza. Detecting Fake Medical Websites using Recursive Trust Labeling, *ACM Trans. Inf. Syst.* 30(4):22 (2012)
- [18] Andrew McCallum, 1999, Text Classification by bootstrapping with keywords, EM and shrinkage. ACL99 - Workshop for Unsupervised Learning in Natural Language Processing

# A Students Attendance System Using QR Code

Fadi Masalha

Faculty of Information Technology  
Applied Science University

Nael Hirzallah

Faculty of Information Technology  
Applied Science University

**Abstract**—Smartphones are becoming more preferred companions to users than desktops or notebooks. Knowing that smartphones are most popular with users at the age around 26, using smartphones to speed up the process of taking attendance by university instructors would save lecturing time and hence enhance the educational process. This paper proposes a system that is based on a QR code, which is being displayed for students during or at the beginning of each lecture. The students will need to scan the code in order to confirm their attendance. The paper explains the high level implementation details of the proposed system. It also discusses how the system verifies student identity to eliminate false registrations.

**Keywords**—Mobile Computing; Attendance System; Educational System; GPS

## I. INTRODUCTION

Taking students' attendance by university instructors during each class is a time consuming process especially when classes are big. Some faculty policies require this task to be performed by the instructor in each lecture. In other words, out of the total hours that are assigned to a given course, which is typically forty-five hours per semester, up to eight hours may be lost to perform this process that usually takes around ten minutes per lecture.

Statistics in [1] shows that 42% of smartphone users have an average age of 26 years old. Thus, with the widespread of smartphones among university students, this paper addresses the problem of such a waste in the lecture time and proposes a system that offers to reduce it by almost 90%. The proposed solution offers a QR code for the students to scan it via a specific smartphone application. The code along with the student identity taken by the application will confirm the students' attendance.

This way, the system will save not only time but also efforts that were supposed to be put by instructors during each lecture. It will speed up the process of taking attendance and leave much time for the lecture to be given properly.

The proposed system also takes care of preventing unauthorized attendance registration using multi-factor authentication. That is, it considers "Something you know", "Something you have", and "Something you are" to confirm the student identity.

In what follows, we will discuss some related work in section 2. In section 3, we will give an overview to QR codes. In section 4, we will explain how the system works, and finally in section 5, we will conclude the paper.

## II. RELATED APPROACHES/WORK

There are many proposals for Automatic Attendance Systems in the literature and in the market. Most of them do focus on applications to be installed on the lecturer device, whether a smartphone or a laptop. In the section, we will mention briefly few of these proposals.

Reference [2] proposes software to be installed in the instructor's mobile telephone. It enables it to query students' mobile telephone via Bluetooth connection and, through transfer of students' mobile telephones' Media Access Control (MAC) addresses to the instructor's mobile telephone; presence of the student can be confirmed.

Reference [3] is another example on a proposal that uses real time face detection algorithms integrated on an existing Learning Management System (LMS). It automatically detects and registers students attending on a lecture. The system represents a supplemental tool for instructors, combining algorithms used in machine learning with adaptive methods used to track facial changes during a longer period of time.

On the other hand, in [4], the proposal uses fingerprint verification technique. They propose a system in which fingerprint verification is done by using extraction of minutiae technique and the system that automates the whole process of taking attendance.

Since biometrics are concerned with the measurements of unique human physiological or behavioral characteristics, the technology has been used to verify the identity of users. It is becoming critical to be able to monitor the presence of the authenticated user throughout a session. Thus, another proposal [5], discusses a prototype system that uses facial recognition technology to monitor authenticated user or students. A neural network-based algorithm was implemented to carry out face detection, and an eigenface method was employed to perform facial recognition. The experimental results demonstrate the feasibility of near-real-time continuous user verification for high-level security information systems.[5]

We noticed that most proposals do involve applications being used by the instructor during class. Hence, if the attendance system requires some action from the instructor, then the class time will be disturbed each time the instructor allows some late students into the class. On the other hand, our proposal does require the instructor to do nothing extra beyond presenting the slides of the course to the students. Hence, students may register their presence at any time they wish during the class, while having in mind that registration times are recorded.

### III. QR CODE: QUICK RESPONSE CODE

QR code (abbreviated from Quick Response Code) is the trademark for a type of matrix barcode (or two-dimensional bar code) first designed for the automotive industry in Japan. Bar codes are optical machine-readable labels attached to items that record information related to the item. It was initially patented; however, its patent holder has chosen not to exercise those rights. Recently, the QR Code system has become popular outside the automotive industry due to its fast readability and greater storage capacity compared to standard UPC barcodes. The code consists of black modules (square dots) arranged in a square grid on a white background. The information encoded may be made up of four standardized types ("modes") of data (numeric, alphanumeric, byte / binary, Kanji) or, through supported extensions, virtually any type of data

A QR code, as shown in Fig.1 is read by an imaging device, such as a camera, and formatted algorithmically by underlying software using Reed-Solomon error correction until the image can be appropriately interpreted. Data is then extracted from patterns present in both horizontal and vertical components of the image. The QR features are listed in table 1. Figure shows a sample of an unencrypted QR code that will be needed by the proposed system.



Fig. 1. Quick Response Code

### IV. THE PROPOSED SYSTEM

The system lies between online learning and traditional learning as a facilitation for the attendance record-keeping process, in a way that enriches the lecture time so that it can better be utilized in giving useful materials rather than wasting the time taking attendance.

The system requires a simple login process by the class instructor through its Server Module to generate an encrypted QR code with specific information. This can be done at any time before the class. During the class, or at its beginning, the instructor displays an encrypted QR code to the students. The students can then scan the displayed QR code using the system Mobile Module, provided to them through the smartphone market by the university. Along with the student's facial image captured by the mobile application at the time of the scan, the Mobile Module will then communicate the information collected to the Server Module to confirm attendance. The whole process should take less than a minute for any student as well as for the whole class to complete their attendance confirmation. Smartphones may communicate with the server via either the local Wi-Fi coverage offered by the institution or through the internet.

TABLE I. CAPACITY, FEATURES, AND STANDARDS FOR QR CODE

	QR Code
Developer (country)	DENSO (Japan)
Numeric	7,089
Alphanumeric	4,296
Binary	2,953
Kanji	1,817
Major Features	Large capacity Small printout size High speed scan
Standards	AIM International JIS ISO

As mentioned earlier, the system is composed of two modules: the Server and the Mobile Modules. The Server Module can be integrated with the eLearning platform used by the institution or it can be a separate application depending on the choice of the developer. The following subsection will describe the tasks for each module.

#### A. Server Module

The Server Module performs the following tasks:

- Mediates students' attendance requests with the eLearning system.
- Generates a QR code for the instructor
- Runs Identity check
- Runs Location check

An example of an eLearning platform, which is an open source application that has become very popular in recent years, is Moodle. Moodle is used by many institutions worldwide. Among its features is Taking Attendance. It allows the instructors to take attendance online by calling names and checking online the appropriate checkbox next the student name. The checkboxes or radio-buttons offered are marked by P for Present, L for Late, and A for Absent. One of the Server Module jobs is to automatically mark the right radio-button on the attendance sheet list.

This module can be developed as a plug-in module to Moodle. When a student sends his/her information via the Mobile Module to the server, as shown in Figure 3, the server in turn sends the Student ID, the lecture date and time, the attendance status, and a small size image of the student face captured by the Mobile Module to the eLearning platform. This way, the Moodle plug-in will save the transaction as well as register the appropriate attendance status. To generate the QR code, the instructor logs in the Server Module or the eLearning system (if the Server Module is developed as part of the eLearning system), to enter the information needed by the system into the QR code.

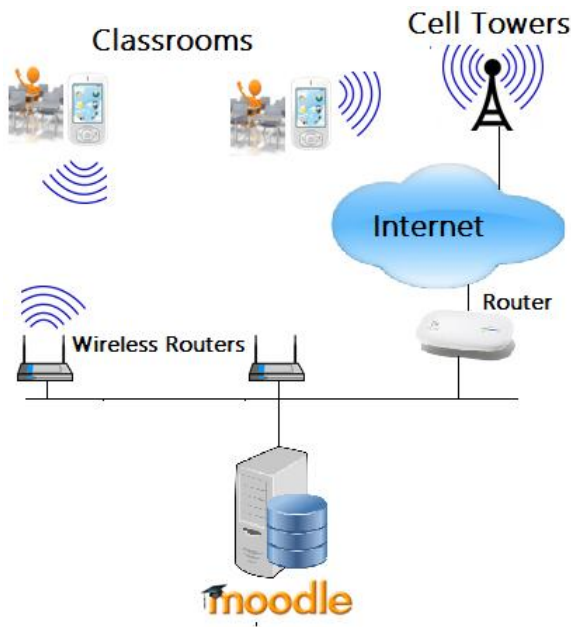

Fig. 2. The proposed system infrastructure

The instructor may choose then to encrypt this code depending on the level of protection needed. The QR code, with or without encryption, will include the following information:

- Course and section ID
- Date and beginning time of the lecture
- Instructor name
- Some random passcode

The information in Fig.1 can be interpreted as shown in Table 2:

TABLE II. TEXT EXTRACTED FROM A QR CODE

<b>Course: 1301120</b>
<b>Section: 1</b>
<b>Instructor: Prof. Nael Hirzallah</b>
<b>Date: 1/1/2014</b>
<b>BeginTime: 10:00AM</b>
<b>Passcode: 6FgT4E</b>

The instructors in turn copy this QR code and paste it on the first slide to be displayed in the lecture. If the instructor policy is to allow late students in his class and would like to mark them as present or late, then the QR code should also be copied on one of the four corners of as many slides as the instructor wishes.

When the students are in class, the first thing that should be done is to pull out their smartphones, open the Mobile Module, and scans the QR code. Figure 3 shows the QR code in one of the slides of the lecture.

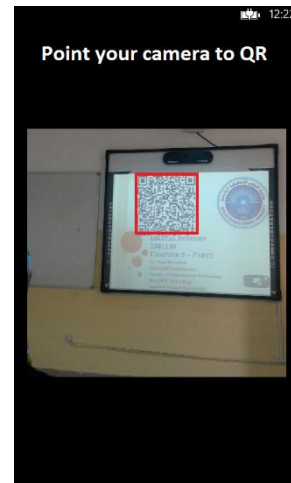

Fig. 3. Snapshot of the first slide

The third task of the Server Module is to run an identity check on the registered students. This is done by comparing the facial image sent per transaction and that stored image on file for the student in question. A matching score will be added to the attendance sheet so the instructor could perform a manual check either during the lecture or after the lecture. The identity check, or image comparisons, can be done once the attendance registration transaction is received, or at a later scheduled time. Although it is recommended to perform the job once the student signs in with the system to be marked as present, but if the number of students and concurrent lectures are large compared to the speed of the server, then the job could be performed say at a random instant in the second half of the lecture. The purpose of this job, is to allow the instructor to check the results of the identity check before the end of the lecture, if he/she wishes to do so.

Finally, a location check will be performed. This task will be discussed later.

### B. Mobile Module

The Mobile Module is the part that students usually install on their smart phones. This could also be integrated with the Mobile part of the eLearning platform, or a standalone application that communicates with the Server Module. As mentioned earlier, the communication will be through the local Wi-Fi network, or it could be through the internet.

As depicted in Figure 4, once the student sees the QR code on the screen, he/she opens the Mobile application. If it is the first time after restarting the Smartphone, the system requests the student to enter a username and password. Once logged in, the system prompts the student to click on the start button. The system will then capture the face of the student. The facial image will be checked against standard facial conditions, such as locating the eyes. Once the image is accepted, the system requests the user to scan a QR code within a very short time. Once the code is scanned, the system sends the information to the server and resumes working in the background. With that, the process is considered completed. The server in turn will send back an acknowledgment that the process is complete.



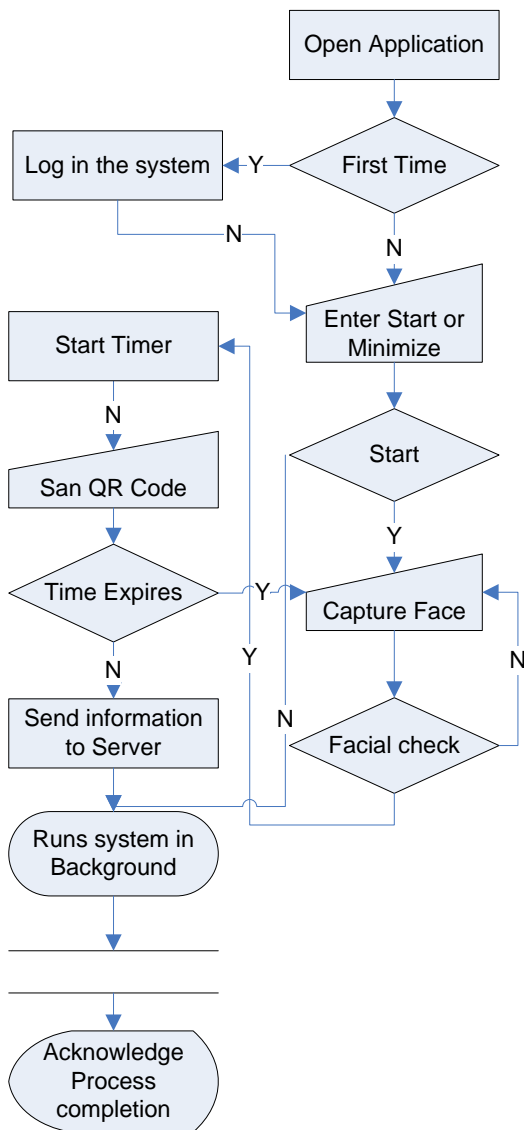

Fig. 4. Mobile Module Flow Chart

As stated in the previous section, the server verifies the identity of the students by running a facial match. The matching weight along with the facial image will be stored against the presence status of the student. The instructor may recheck any of the student's presence during the lecture by manually checking the updated attendance list that shows the matching weights during or after class.

## V. ANALYSIS

Standard security procedures require a simple username and password. Such information is called "Something you know" or "What you know". Thus, it is easy for unauthorized users to gain access to a user's private data such as personal and financial details and then use that information to commit fraudulent acts.

Using a username and password together with a piece of hardware or device that only the user has makes it harder for potential intruders to gain access and steal that person's personal data or identity.

The proposed system will need three steps from each student. These steps are opening the application, capturing the face, and scanning the QR code. The system uses multi-factor authentication to authenticate students. These are "something you know" which is represented by username and password, "something you have" which is represented by the Smartphone owned by the student, and finally "something you are" which is represented by matching the facial image of the student. Thus, unauthorized users are not easy to get access to changing the presence status of one student.

However, for taking attendance, the challenge is in the fact that the system must guarantee that such a process do really take place within the classroom and not outside. The only fraudulent act that may happen is when a student sitting outside a classroom receives an image of the displayed QR code from a student sitting inside, via some communication medium such as email. This may be enough to simulate the process as if it taken place inside the classroom. To prevent this, the location of the Mobile phone information will accompany the information sent to the server.

Currently, Global Navigation Satellite Systems, (GNSS) receivers are becoming more and more sensitive due to ceaseless progress in chip technology and processing power. High Sensitivity GNSS receivers are able to receive satellite signals in most indoor environments and attempts to determine the 3D position indoors have been successful, [6].

Besides increasing the sensitivity of the receivers, the technique of A-GPS can be used, where the almanac and other information are transferred through a mobile phone. Furthermore, as smart phones embrace always-on, ubiquitous location, location-based sensor fusion will become a standard feature.

ABI Research's report, "Location-based Sensor Fusion: Companies, Technologies, and Revenue Opportunities," [7] outlines how sensor fusion will evolve to support indoor location and the companies best placed to succeed in this space.

Once the location information is sent to the server, the center of class will be calculated for all the smart phones locations received until the time of the check. The distance from the center of each Smartphone will be recorded along with the facial matching weights. This will allow the instructor to do a check on the awkward positions of the phones or awkward matching weights during class. In other words, the following information will be communicated to the server per transaction:

- Student ID from application account
- Class and time details from QR code
- Smartphone location from device

The list of attendance that shows the status of the student versus the Facial matching weight and Distance can be presented to the instructor upon his/her request. Figure 5 shows an updated attendance list after both facial image matching and distance calculations processes are performed.

Regular class session		View mode   Sort						
#	First name / Surname	P	L	E	A	Facial	Distance	Remarks
1	محمد احمد البدرى	●	○	○	○	8g	2	
2	رؤف اسامه عبدالله	●	○	○	○	8o	4	
3	سيف الدين يوسف ابراهيم المكي	○	○	○	●	-	-	
4	ندوم برهان نديم البستاني	○	●	○	○	8g	1	
5	ياسمين به خنجر مسعود مسعود	●	○	○	○	81	2	
6	خالد حريص بن ابراهيم	○	○	○	○	-	-	
7	علي حسن عيسى حسن	●	○	○	○	91	2	
8	علي حيدر محمودة العرس	●	○	○	○	92	2	
9	اسماعيل زيد قاسم محمد	○	●	○	○	o1	4	

Fig. 5. Updated Attendance Sheet

Figure 6 shows snapshots of the Mobile application.

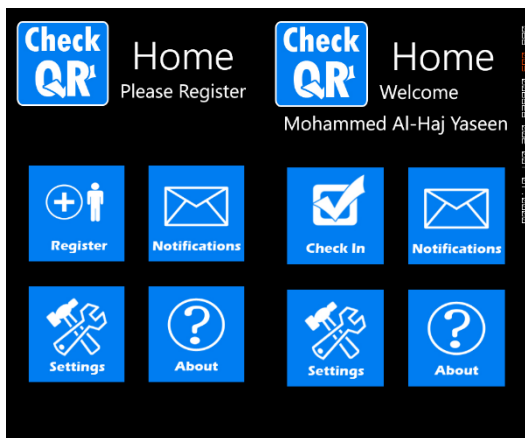

Fig. 6. Snapshots of the Mobile Module

## VI. CONCLUSION

These days it is required to keep up with the latest technologies, especially in the field of education. Educational institutions have been looking for ways to enhance the educational process using the latest technologies. Looking at the existing situation, we have thought of using the mobile

technology to efficiently benefit from the complete assigned time assigned to a lecture. Time taken by instructors to take attendance may be viewed sometimes as a waste of the lecture time, especially when classes are big. For that, we have proposed a way to automate this process using the students' devices rather than the instructor's device. In other words, the instructor need not do anything extra during the class beyond presenting the slides of the subject to be taught to the students.

The proposed system allows fraud detection based on the GPS locations as well as the facial images taken for each student.

## ACKNOWLEDGMENT

The authors wish to acknowledge the financial support received from Applied Science University that helped in publishing this article.

## REFERENCES

- [1] Smartphone Users Around the World – Statistics and Facts, <http://www.go-gulf.com/blog/smartphone/> visited on February 12, 2014
- [2] Jamil, T. ; Dept. of Electr. & Comput. Eng., Sultan Qaboos Univ., Al Khod, Oman, Automatic attendance recording system using mobile telephone , Telecommunications Forum (TELFOR), 2011 19th 1297 - 1299
- [3] Shehu, V. ; Contemporary Sci. & Technol., South East Eur. Univ., Tetovo, Macedonia ; Dika, A. , Using real time computer vision algorithms in automatic attendance management systems, Information Technology Interfaces (ITI), 2010 32nd International Conference on 397 – 402
- [4] Saraswat, Chitresh; Kumar, Amit, An Efficient Automatic Attendance System using Fingerprint Verification Technique. International Journal on Computer Science & Engineering . 2010, Vol. 2 Issue 2, p264-269
- [5] Qinghan Xiao ; Interdept. Biometrics Working Group, Gov. of Canada, ON ; Xue Dong Yang, A facial presence monitoring system for information security, Computational Intelligence in Biometrics: Theory, Algorithms, and Applications, 2009. CIB 2009. IEEE Workshop on, March 30 2009-April 2 2009 , 69 - 76
- [6] Indoor Positioning: [http://en.wikipedia.org/wiki/Indoor\\_positioning\\_system#cite\\_note-15](http://en.wikipedia.org/wiki/Indoor_positioning_system#cite_note-15) visited on January 10, 2014
- [7] Location-based Sensor Fusion <https://www.abiresearch.com/research/product/1015686-location-based-sensor-fusion-companies-tec/> visited on January 10, 2014



# An autonomous intelligent gateway for wireless sensor network based on mobile node

Hajar Mansouri

Equipe Architecture des systèmes (EAS)  
Laboratoire d'Informatique Systèmes et Énergies  
Renouvelables (LISER), ENSEM, Université Hassan II  
Casablanca, Morocco

Fouad Moutaouakil, Hicham Medromi

Equipe Architecture des systèmes (EAS)  
Laboratoire d'Informatique Systèmes et Énergies  
Renouvelables (LISER), ENSEM, Université Hassan II  
Casablanca, Morocco

**Abstract**—One of the recent tendencies for Wireless Sensor Networks (WSNs) that significantly increases their performance and functionality is the utilization of mobile nodes. This paper describes the software architecture of an intelligent autonomous gateway, designed to provide the necessary middleware between locally deployed sensor networks based on mobile node and a remote location. The gateway provides hierarchical networking, auto management of the mobile wsn (MWSN), alarm notification and SMS/Internet access capabilities with user authentication. Our architecture includes three multi agent system modules, an interface module, a management module and a treatment module. The management module consists of two agents, a control communication agent, and a learning agent. The control communication agent interacts with the interface module and the treatment module in order to decide which data mule can reach the target. Several factors such as battery status, coverage issues, and communication situations have been taken into consideration.

**Keywords**—Mobile Wireless Sensor Network; Multi Agent Systems; gateway; mobile nodes

## I. INTRODUCTION

Recent developments in wireless communication and electronics have made possible the development of small, inexpensive, low power, distributive devices. These devices are capable of local processing and wireless communication and are known as sensor nodes. A sensor network can be described as a collection of sensor nodes which co-ordinate with each other to perform some specific function. The wireless sensor network (WSN) has been widely spread out in a variety of surveillance applications. Examples includes environmental monitoring, smart home facility, seismic detection, military surveillance, inventory tracking, smart spaces, etc [1][2][3].

Limited energy is one of the key challenges, considering the motes are most often battery operated. Maintaining the network (e.g. replacing batteries) is a critical restriction as it is usually difficult to access to nodes due to their location. Power supply that harvests power from the environment such as solar panels may be added to the node depending on the appropriateness of the environment where the sensor will be deployed [4]. However, external power supplies often have a non-continuous behavior, thus making the presence of the battery essential [5]. A number of approaches have been

proposed as a solution to the problem of energy efficient: Duty cycling, data driven, mobility, etc [6][7][8].

The advances in mobile robotics allow us today to add the mobility concept into many different classes of Wireless Sensor Networks [9]. Data mule has been considered as an alternative solution for this problem of data gathering. A mule is a mobile device that can visit locations within the communication distance of each of the static motes, download their measurements and return to a remote base station to load the collected data. The key benefit of this approach is that motes can conserve energy that they would otherwise use to forward data, thereby prolonging the network's lifetime. In addition to reducing the energy consumption during transmission (less power is needed), proximity also reduces the data loss rate, which results in smaller number of transmissions per byte. Finally, recharging the robots' batteries is a simpler operation than replacing motes' batteries.

In this paper we propose original architecture based on agent for an intelligently communication and data management (collecting and processing data) of wireless sensor network based on mobile node. In fact an agent is a software entity which functions continuously and autonomously in a particular environment, often inhabited by other agents and processes. In the multi-agents systems, the global behavior derives from the interaction among the constituent agents. Agents interact (cooperate, coordinate or negotiate) with one another, either to achieve a common objective or because this is necessary for them to achieve their own objectives [9][10].

The rest of this paper is arranged as follows: section 2 gives an overview on many WSN projects that use mobile relay; in section 3 we present our architecture then his modeling and implementing with Agent UML. Some conclusions are presented in section 5.

## II. STATE OF ART:

There have been many works related to mules.

[11] Present a data muling system which uses uncontrolled entities (such as animals, humans with wireless devices) for carrying data. The authors present three tiers sensor network architecture. The bottom layer consists of a sparse sensor network. In the middle layer there are mobile

entities such as vehicles and humans which carry the data from bottom layer to the access points in the top level. These ideas were also implemented in real systems in Zebra Net [12] and Smart-tag [13] projects. In [14] the authors use mobile mules (human) for collecting data from an isolated WSN. They propose a distributed storage management strategy (DSMS) for data buffering. DSMS can reduce data loss while keep higher-priority packets closer to the sink area. Properties of DSMS have been proved and its efficiency has been verified by simulation and real implementation. [15] Consider the data gathering issue in a spatially separated wireless sensor network, where sensor nodes may form several isolated subnetworks, each far away from each other. Mobile mules are adopted to traverse these subnetworks to conduct data collection. To address issues of data collection latency and network lifetime simultaneously, authors formulate a new problem; called EM-TSP to find mules traversal paths to visit each subnetwork in at least one landing port such that the energy consumption of sensors is bounded and the traversal path lengths of mules are minimized. [16] Present a robotic system for collecting data from wireless devices dispersed across a large environment. They address the problem of planning paths of robotic mules referred to as Gathering Problem (DGP) in order to collect the data from all sensors in the least amount of time. Authors propose an optimal algorithm for the 1D version where the robots are restricted to move along a curve and for the 2D case they present a constant factor approximation algorithm for DGP on the plane. Utility of the algorithms has been demonstrated in simulations and has been implemented on a data muling system.

Our work was motivated by the fact that none of the works presented in the state of the art were interested on the capacity of gateway to manage the wireless sensor network based on mobile node from the reception of the request to its execution.

### III. PROPOSED ARCHITECTURE

The architecture presented in this work is a multi-agent architecture, in which each agent is autonomous and able to cooperate, coordinate and communicate with other agents intelligently to achieve the system task which is treatment of the user request, manage mobile node, environmental data collection and the notification of users.

Our architecture is based on a three tiers network structure "Fig.1". The lowest layer is a random deployed network composed of sensor nodes (static nodes). These nodes are able to communicate immediately with upper layer agent in near range. They can also form an ad hoc network by communicating with each other, but it is not necessary. The most notable feature of medium layer is its mobility.

The mobile agents (data mules) move to anywhere at any time if needed. They are responsible for gathering data from lower layer and then forwarding to upper layer. The highest layer represents the fixed network consisted of access point that act as a gateway between sensor nodes and the end user [17]. Data mules are bundled with infrarouge, zigbee, bluetooth and wifi communication, by mean of which it can receive commands and send response. The gateway receives requests from user, collects and processes the data from mobile nodes and notifies the user using sms if any event is

detected. The gateway is equipped with bluetooth, wifi, and gsm modem.

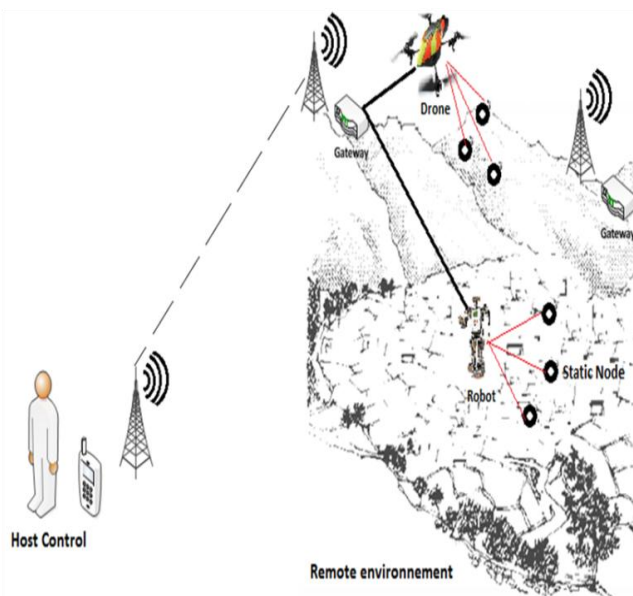

Fig. 1. Three tiers architecture

#### A. Agents

An agent can be defined as a software entity evolving in an environment that it can perceive and in which it acts. It is endowed with autonomous behaviors and has objectives. Autonomy is the main concept in the agent issue: it is the ability of agents to control their actions and their internal states. Agents can be classified as cognitive or reactive [18]. Reactive agents are elementary agents without memory and with a defined position in time and space. Cognitive agents, instead, behave in a more complex way, and their actions are based also on past experience. Whereas cognitive agents, for every possible sequence of perceptions, act to maximize a given utility function [19], reactive agents perform their actions in consequence of the perception of stimuli coming either from other agents or from the environment.

The gateway is represented by agents "Fig.2". The agents can be reactive or cognitive and they are provided with two functions, the communication and the realization of the application tasks. The task of communication consists of passing information to the other agents or simply to relieve messages for the other agents, every agent have capacity of communication but their behavior in front of a message depends of their role in the organization [20].The specific tasks consists of checking, trying, normalizing data etc.

The multi agent architecture of the gateway, appear in the form of three under multi-system agents called: Multi Agent System Treatment, Multi Agent System Management and Multi Agent System Treatment "Fig.3,4,6". These modules collaborate between them in a continuous way to ensure the functionalities of the gateway. Below, a description of these modules.

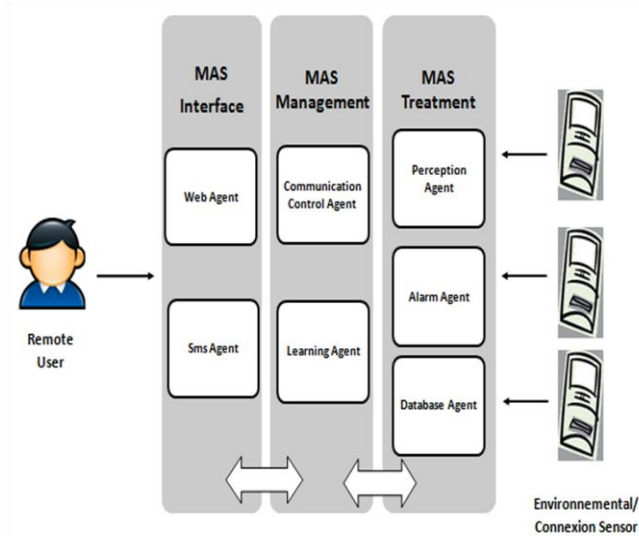

Fig. 2. Multi Agent architecture of the gateway

**B. MAS Interface**

The multi agent system interface represents the highest layer of our architecture. MAS manages all connections between the gateway and the remote user, it authenticates users and verifies the validity of the requests. This system contains two types of agents: SMS agent and web agent. The SMS agent receives SMS stream input. It verifies the identity of the user using a dual factor authentication. The web agent receives as input the html stream. It authenticates web users and normalizes the data to send to the management agent. Authentication is done with the validation code (password) that the legitimate user has got via SMS in the previous step (SMS agent).

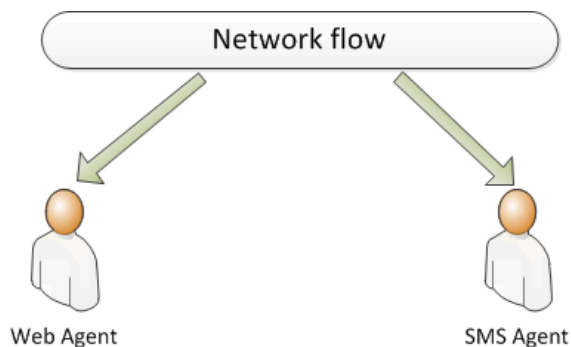

Fig. 3. Multi Agent System Interface

**C. Mas Management**

The multi agent system Management manages all connections between the gateway and the mobile nodes. It

contains two agents. Communication control agent (CCA) and Learning agent (LA). CCA receives the request sent by the remote user through the multi agent system interface (MASI). It launches the multi agent system treatment (MAST) to collect and retrieve information about mobile nodes deployed in the environment. This information relates to the position of each mobile and its battery level node.

**1) Communication Control Agent :**

When the CCA receives the data stream sent by the MAST, it reasons in order to decide the choice of the mobile node best suits the target to reach. In our case we have chosen the Belief-Desire-Intention (BDI) agent architecture to model the communication control agent. The BDI model is one of the most successful theoretical models of rational agents. This model allows the agent to maintain a belief base (BC) and complete deductive reasoning through the manipulation of the BC.

**2) Learning Agent :**

It establishes the connection between the management agent and the knowledge base. The knowledge base contains all the rules necessary for the gateway to decision making: Mobile node to activate, communication media to choose etc. We can also find the history of actions established by the gateway. This history allows the management agent to define its action plan directly and quickly without the need to establish a new representation of the environment.

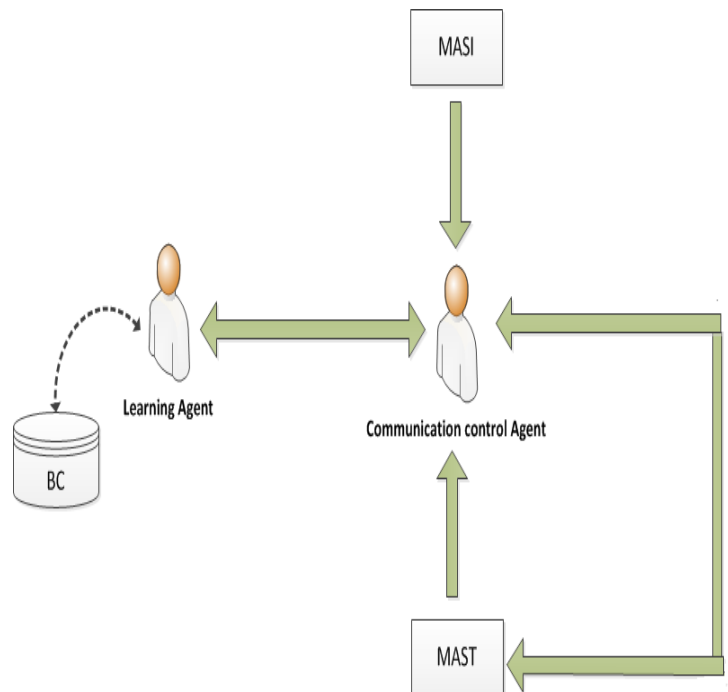

Fig. 4. Multi Agent System Management

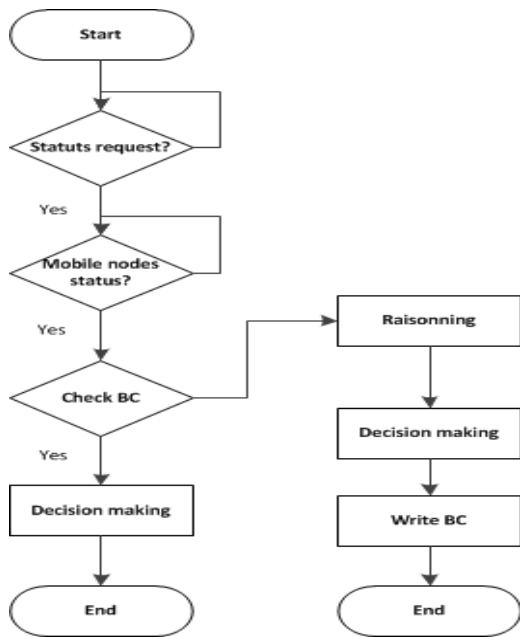

Fig. 5. Flow chart control communication agent

#### D. MAST

Multi agent system Treatment represents the interface between the gateway and the environment to monitor. MAST is responsible for the manipulation and the pretreatment of collected data. It includes perception agent, alarm agent and database agent.

Perception agent (PA) is responsible for collecting data from environment. Pretreatment includes verification of input data, the ability to identify malfunctions and finally, transmitting of measured values pretreated to the other agents. The main objective of handling preprocessed values is the identification of anomalies and the launching of alarms. Alarm agent (AA) allows sending alarm messages to remote users when some data goes above or below a certain threshold. The database agent (DA) is responsible for the updating of environmental databases with data from the sensor nodes. This task, although trivial, is vital for system performance.

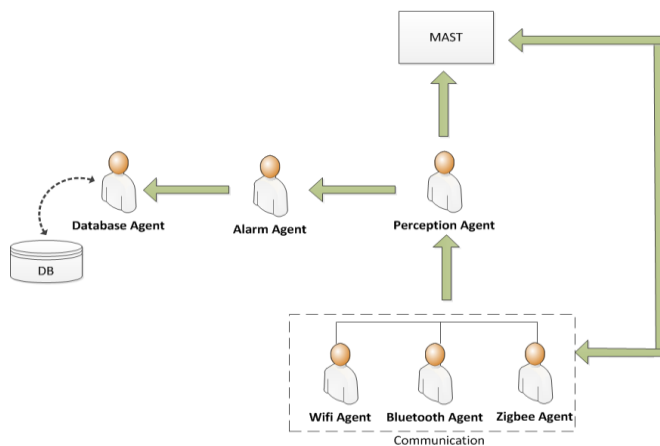

Fig. 6. Multi Agent System Treatment

#### IV. IMPLEMENTING THE PLATFORM

We validate our approach by implementing the proposed architecture in soekris box. Each box has an embedded UNIX system, an IEEE 802.11 interface and a 3G modem. An NXT robot was deployed on top of each Soekris box for interfacing to the statics sensors (Tier 1). Communication between the mobile node and the soekris is made via wifi. As shown in "Fig.7", the wsn is composed of arduino motes deployed in a star topology in an indoor environment. One of the issues currently being tackled is the monitor physical or environmental conditions, such as temperature.

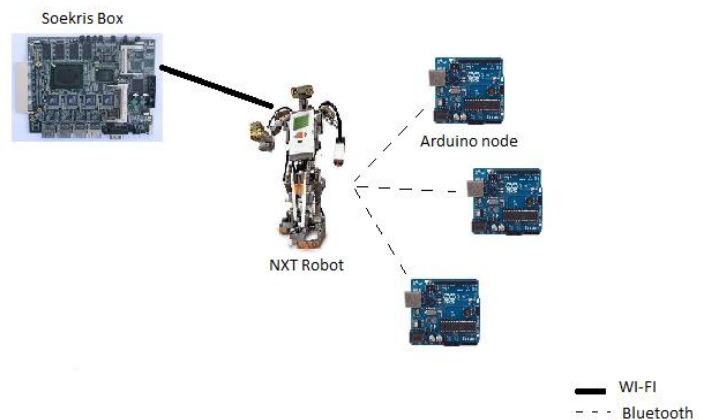

Fig. 7. Test platform

#### A. Designing the model

In this section we propose a new design methodology based on the AUML language. Agent UML is an extension of UML to take into account the agent notions. Agent UML inherits representations proposed by UML [21][22]. It contains 13 diagrams types symbolizing many different views to represent particular concepts of information system. They fall into three main groups:

Diagrams behavioral:

- ✓ Use Case Diagram
- ✓ Activity Diagram
- ✓ State Machine (State Chart) Diagram

Structural diagrams:

- ✓ Class Diagram
- ✓ Object Diagram
- ✓ Component Diagram
- ✓ Composite Structure Diagram
- ✓ Package Diagram
- ✓ Deployment Diagram

Interaction Diagrams:

- ✓ Sequence Diagram
- ✓ Communication Diagram
- ✓ Timing Diagram
- ✓ Interaction Overview Diagram

These diagrams are not necessarily all used at modeling. The design of the proposed architecture is described through

the two diagrams of use cases and classes of agents to illustrate the static aspect of the distributed platform developed.

1) *Static aspect*

Agent UML allows the representation of several levels of abstraction in the design class diagrams. We consider these two levels: the conceptual and implementation levels.

a) *The conceptual level*

It is high enough for the multi-agent system eliminating all surface information for understanding the structure of the system. The agent class diagram in “Fig.8” shows the conceptual level of the platform.

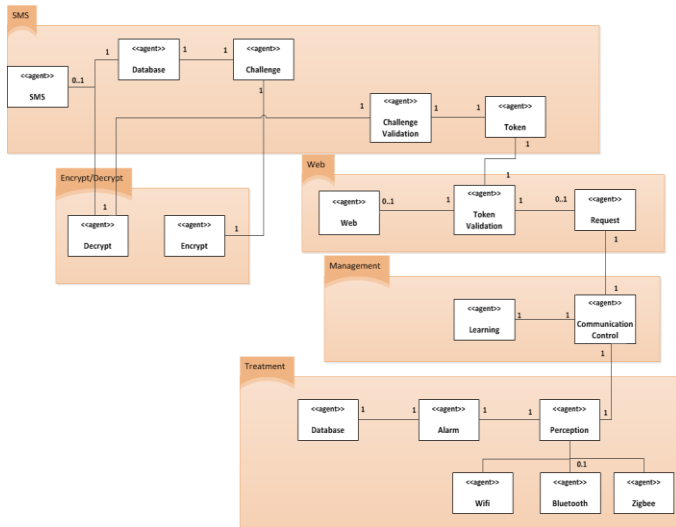

Fig. 8. Class diagram (conceptual level)

b) *The implementation level*

This gives in detail the contents of agents. “Fig.9” shows a portion of the class diagram for the agent’s level implementation

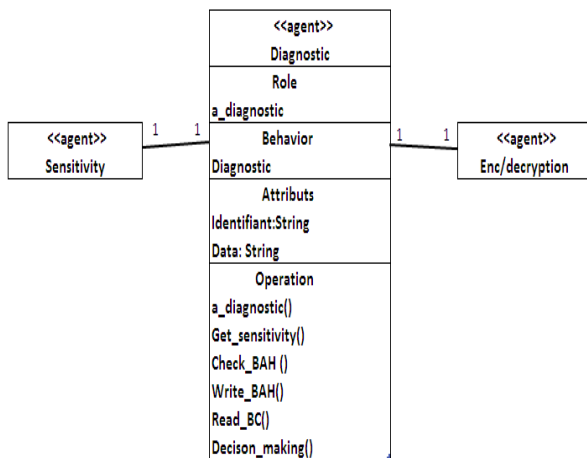

Fig. 9. Class diagram level implementation agents

2) *Dynamic aspects*

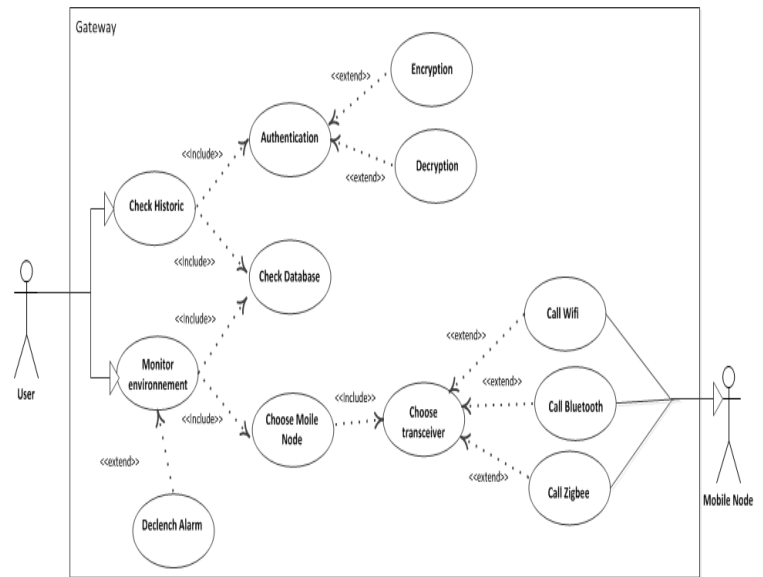

Fig. 10. Use case diagram

V. CONCLUSION

In this paper we have proposed a new generic distributed architecture based on multi-agent systems for mobile wireless sensor networks. Our architecture was developed and implemented in soekris box. This architecture allows a user to gather all the information sensed by the wsn, as well as to send commands to a group or individual mobile node. Moreover the agents assigned to our gateway autonomy and intelligence in the management of mobile nodes taking into account several factors such as battery status, coverage issues, and communication situations.

In the future work, we plan to test our architecture using drones as mobile nodes. Secondly, we plan to reduce the latency of our network. The solution consists of finding mules traversal paths to visit each subnetwork in at least one landing port such the traversal path lengths of mules are minimized.

References:

- [1] A. Mainwaring, D. Culler, J. Polastre, R. Szewczyk, and J. Anderson, “Wireless sensor networks for habitat monitoring,” in Proceedings of the 1st ACM international workshop on Wireless sensor networks and applications (WSNA02: ), 2002, pp. 88–97.
- [2] T. He, P. Vicaire, T. Yan, L. Luo, L. Gu, G. Zhou, R. Stoleru, Q. Cao, J. A. Stankovic, and T. Abdelzaher, “Achieving real-time target tracking using wireless sensor networks,” in Proceedings of the 12th IEEE Real-Time and Embedded Technology and Applications Symposium (RTAS06), 2006, pp. 37–48.
- [3] J. A. Stankovic, Q. Cao, T. Doan, L. Fang, Z. He, R. Kiran, S. Lin, S. Son, R. Stoleru, and A. Wood, “Wireless sensor networks for in- home healthcare,” in Proceeding of High Confidence Medical Devices, Software, and Systems (HCMDSS05), 2005, pp. 2–3.
- [4] J.Yick, B.Mukherjee, D.Ghosal, “Wireless Sensor Network Survey”, computer networks 52 (2008) 2292–2330.
- [5] C. Alippi and C. Galperti, “An adaptive system for opimal solar energy harvesting in wireless sensor network nodes,” IEEE Transactions on Circuits and Systems I, vol. 55, no. 6, pp. 1742–1750, 2008.

- [6] Z.Rezaei, S.Mobininejad, "Energy Saving in Wireless Sensor Networks," International Journal of Computer Science & Engineering Survey (IJCES) Vol.3, No.1, February 2012.
- [7] L-Shi Baoxian Zhang, K.Huang, J.Ma, "An Efficient Data-Driven Routing Protocol for Wireless Sensor Networks with Mobile Sinks," Published in: Communications (ICC), 2011 IEEE International Conference on, kyoto, 5-9 June 2011.
- [8] K.Han,L.Xiang,J.Luo, "Energy Efficient reliable data dissemination in -cycled wireless sensor networks," MobiHoc '13 Proceeding of the fourteenth ACM international symposium on Mobile ad hoc networking and computing.
- [9] H.Mansouri, A.Sayouti,H.Medromi "A GSM based remote wireless automatic monitoring of mobile robot," International Journal of Research & Reviews in Computer Science . Jun2012, Vol. 3 Issue 3, p1622-162.
- [10] M. El Bakkali, S. Benaissa, S. Tallal, A. Sayouti, H. Medromi "EAAS3, Distributed Control Architecture of MAS Robotic Systems", International Review on Computers and Software (IRECOS), Vol. 8 N. 3, March 2013.
- [11] R.C.Shah, S.Roy, S.Jain., and Brunette, "Data mules: Modeling a three-tier architecture for sparse sensor networks," In Proc. of the IEEE Workshop on Sensor Network, 2003.
- [12] P. Juang, H. Oki, Y.Wang, M. Martonosi, L.Peh, D .Rubenstein, "Energy-efficient computing for wildlife tracking: design tradeoffs and early experiences with ZebraNet",ACM ASPLOS,San Jose,CA,USA,October 2002.
- [13] M.Leopold, P.Bonnet, "Smart-tag based data dissemination", A Beaufour, Proceedings of the 1st ACM international workshop on Wireless sensor . 68-77, 2002/9/28.
- [14] Y-C.Tseng, W-T.Lai, C-F.Huang, and F-J.Wu, "Using Mobile Mules for Collecting Data from an Isolated Wireless Sensor Network,"ICPP 10 Proceedings on the 2010 39th International Conference on Parallel Processing, pp 673-679.
- [15] F-Jing.Wu,Y-Chee.Tseng, "Energy-Conserving Data Gathering by Mobile Mules in a Spatially Separated Wireless Sensor Network." Wirel. Commun. Mob. Comput. 2010; 00:1-18, DOI: 10.1002/wcm.
- [16] D.Bhadauria, O.Tekdas ,V.Isler,"Robotic Data Mules for collecting Data over Sparse sensor field," Journal of Field Robotics Volume 28, Issue 3, pages 388-404, May/June 2011.
- [17] S-A.Munir, X.Dongliang, C.Canfeng and J.Ma (2011). "Mobile wireless sensor networks: architects for pervasive computing, wireless sensor networks," (ed.), isbn: 978-953-307-325-5, intech.
- [18] K. Fischer, I. J. Timm, and E. André, "Introduction to the special issue on the Fourth German Conference on Multiagent System Technologies (MATES)," Autonomous Agents and Multi-Agent Systems (AAMAS) vol. 18, no 2, pp. 219, 2009.
- [19] J. L. Dessalles, J. Ferber, and D. Phan, Emergence in agent based computational social science: conceptual, formal and diagrammatic analysis, In Y.Shan (Ed.), Intelligent Complex Adaptive Systems, 1(New York: IGI Publishing ,2008, pp. 1-24).
- [20] J.P Jamont, M.Occello, "Une approche multiagent pour la gestion de la communication dans les réseaux de capteurs sans fil, " Revue des sciences et technologies de l'information, Technique et Science Informatiques, vol 25, no.5, pp.661-688.
- [21] M.Huget,"Une application d'AgentUML au Supply Chain Manangement," JFIADSM, 2002.
- [22] H.mansouri,S.Benhadou,H.Medromi, "Energy Security Optimization in Wireless Sensor Network Based on Multi Agent System," International Review on Computers & Software . Mar2012, Vol. 7 Issue 2, p518-524.



# Sample K-Means Clustering Method for Determining the Stage of Breast Cancer Malignancy Based on Cancer Size on Mammogram Image Basis

Karmilasari, Suryarini Widodo, Matrisya Hermita,  
Nur Putri Agustiyani, Yuhilza Hanum  
Dept. of Information System  
Faculty of Computer Science &  
Information Technology  
Gunadarma University  
Depok, Indonesia

Lussiana ETP.  
Dept. of Information Systems  
STMIK Jakarta STI&K Jakarta,  
Jakarta, Indonesia

**Abstract**—Breast cancer is a disease that arises due to the growth of breast tissue cells that are not normal. The detection of breast cancer malignancy level / stage relies heavily on the results of the analysis of the doctor. To assist the analysis, this research aims to develop a software that can determine the stage of breast cancer based on the size of the cancerous tissue. Steps of the research consist of mammogram image acquisition, determining the ROI (Region of Interest), using Region growing segmentation method, measuring the area of suspected cancer, and determine the stage classification of the area on the mammogram image by using Sample K-Means Clustering method. Based on 33 malignant (abnormal) mammogram sample images taken from the mini mammography database of MIAS, the proposed method can detect stage of breast cancer is in malignant group.

**Keywords**—classification; staging; breast cancer; mammogram; k-means clustering

## I. INTRODUCTION

Cancer is a group of diseases that cause cells in the body to change and grow out of control. Most types of cancer cells eventually form a lump or masses called a tumor, and are named after the part of the body where the tumor originates. Breast cancer begins in breast tissue, which is made up of glands for milk production, called lobules, and the ducts that connect lobules to the nipple. The remainder of the breast is made up of fatty, connective, and lymphatic tissue [1].

Breast cancer is leading cause of cancer deaths among women. In 2013, an estimate 232.340 new cases of invasive breast cancer will be diagnosed among women, as well as an estimated 64.640 additional cases of in situ breast cancer, and approximately 39.620 women are expected to die from breast cancer [1]

Detection and diagnosis of breast cancer in its early stage increases the chances for successful treatment and complete recovery of the patient. Screening mammography is currently the best available radiological technique for early detection of breast cancer [2]. It is an x-ray examination of the breasts in a woman who is asymptomatic. Mammography detects around 80% to 90% of breast cancers [3]. Masses or abnormalities detection at early stage is quite possible with the usage of

mammography. Mammography is used as a primary tool for detecting breast cancer[4].

There are several stages to breast image processing. The first stage, breast image acquisition through mammography. The next stages are pre-processing image, segmentation, feature extraction, feature selection and classification [5]. With technique digital mammography, characteristics calcification, circumscribed, speculated and other ill defined masses can be diagnosed [6]

Breast cancer is the type of silent cancer because there is no typical symptoms suffered. Most people find this disease after entering the level of high stage of malignancy. Breast cancer stage is used to describe the condition of cancer, namely its location, its size, where it spreads and the extent of its influence on other organs .

In general , the level of breast cancer stage is stage I , II , III and IV [7]. In fact, determining the level of breast cancer stage is not easy. Many factors differ between the levels of the stadium .

The aim of this paper is to propose a method to determine the stage of breast cancer malignancy based on cancer size on mammogram image based on cancer size. This work is organized as follows. In Section 2, literature review that related work are presented. In Section 3, we present the proposed method includes the process of segmentation and classification. Next, in Section 4, the results are shown. Finally, Section 5 presents some concluding remarks.

## II. LITERATURE REVIEW

Breast cancer detection can be carried out by using a variety of techniques. For successful treatment of the patient the breast cancer has to detected in its early stage and thus the patient can be recovered quickly. For breast cancer detection, the mammogram images will be collected in the first stage, after the image acquisition stage preprocessing will be performed. Next stage will be the image enhancement in which in the resultant image the finer details will be more clearer than the original image, the image will be segmented to extract the microcalcification part or cancer detected area.

Various technique used in breast cancer detection is described below:

#### A. Segmentation Technique

Segmentation is the process of partitioning a digital image into multiple segments. By segmentation technique it is easy to change the representation of an image so it will be easier to analyze and it is easy to locate objects and boundaries in images. In this technique image can be segmented and the set of segments will cover the entire image. Segmentation can be carried out using any of the standard techniques like Local Thresholding, K-Means Clustering, Otsu Segmentation Technique [8].

Thresholding is a way to change an image that has a level of grayscale or true color into an image with fewer color levels, in this case bilevel color is used. Bilevel image is a color image which is divided into two colors, 0 (black) and 1 (white). Simplification of color using thresholding is widely used for pattern recognition by eliminating color complexity into simple color so that an observed image has a color pattern which characteristics are easily grouped.

Otsu's method is used to automatically perform clustering-based image thresholding, or, the reduction of a graylevel image to a binary image [9]. The algorithm assumes that the image to be thresholded contains two classes of pixels or bimodal histogram (e.g. foreground and background) then calculates the optimum threshold separating those two classes so that their combined spread (intra-class variance) is minimal. The extension of the original method to multi-level thresholding is referred to as the Multi Otsu method.

#### B. Edge Detection Method

Detection of edges in an image is a very important step towards understanding image features. Since edges often occur at image locations representing object boundaries, edge detection is extensively used in image segmentation when images are divided into areas corresponding to different objects. This can be used specifically for enhancing the tumor or cancer area in mammographic images. Different methods are available for edge detection like Roberts, Sobel, Prewitt, Kirsch and Laplacian of Gaussian edge operators [10].

#### C. Region Growing

Region Growing is a procedure that classifies the pixels or sub-regions into larger regions based on predefined criteria. The approach basically starts from the beginning of the set of points, then the area is enlarged by adding each neighboring pixel point that has properties similar to those points (for example the range of intensity or color specification).

The selection of similar criteria, in addition to depending on the problem at hand, also depends on the type of image data available, for example descriptor. Examples of descriptors include moment and texture. Region-growing segmentation provides the clear edges of the images. [11]. Region growing segmentation can be implemented to breast cancer detection [12].

#### D. Clustering K-Means

K-Means is a technique that is quite simple and quick clustering data. The main principle of this technique is to develop a k prototype/center of mass (centroid)/average (mean) of n-dimensional data set. This technique requires that the value of k is already known in advance (a priori). K-Means algorithm begins with the formation of initial prototype cluster. Then the prototype cluster is improved iteratively to converge (no significant changes to the prototype cluster). This change is measured using an objective function J which is generally defined as the sum / average distance to the centroid of each group of data. K-Means algorithm can be implemented to masses detection on digitized mammogram [13]

### III. PROPOSED METHOD

The method proposed in this paper is to classify the stages of malignancy of breast cancer based on the mammogram image, through segmentation by sample K-Means clustering method.

Stages of the proposed method are outlined in Fig 1.

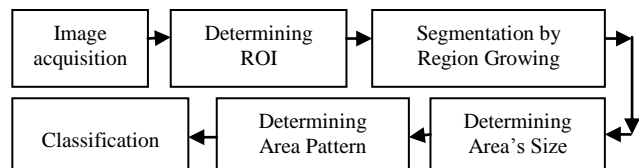

Fig. 1. Proposed method

The initial step is the image acquisition to get the data in the form of mammogram digital images that are required in the research. Mammography Image Analysis Society (MIAS) database used in this research [14]. Data is in the form of image format PGM (Portable GrayMap). PGM format is used by many medical image as a PGM is a lossless type image format where at the time of data compression, no parts are removed so that the details of the image will remain intact and not lost. Each mammogram image has a resolution of 1024x1024 pixels and the average file size of 1MB. MIAS database have been grouped into three categories, namely: (1) Dense-Glandular is the mammogram image of breasts that are dense and have many glands by nature (2) Fatty is the mammogram image of breasts that are not dense by nature because they contain a lot of fat, and (3) Fatty -glandular is a mammogram image of breasts that are not dense because they contain a lot of fat and have many glands.

Each of the three categories is further grouped into three sections, namely: (1) Normal, is a collection of normal mammogram images that are not affected by breast cancer, (2) Benign, is a collection of abnormal mammogram images that have been affected by benign breast cancer on breast tissue, and (3) malignant, is a collection of abnormal mammogram images that have invasive breast cancer. Figure 2 shows hierarchy MIAS database. In this research, 33 malignant (abnormal) mammogram images are used as test data and training data. Figure3 shows one abnormal image used in this research.

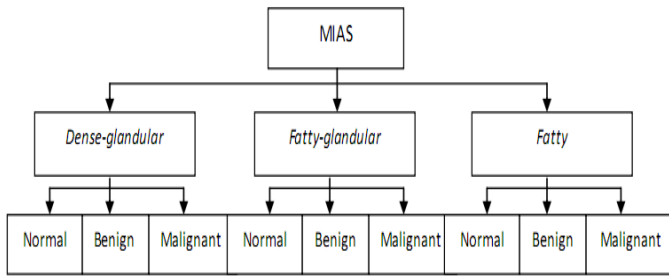

Fig. 2. Hierarchy MIAS database

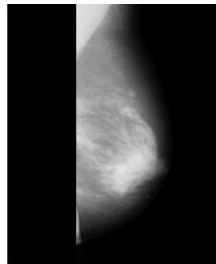

Fig. 3. Example malignant (abnormal) mammogram in MIAS

After image acquisition, the next step is the determination of the Region of Interest (ROI). The details of ROI determination step are shown in Figure 4.

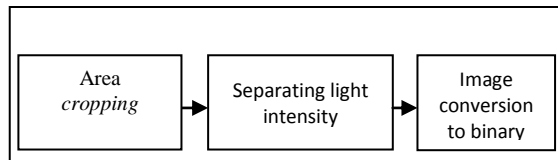

Fig. 4. Determining ROI in detail.

Region of Interest (ROI) allows for coding differently in certain areas of the digital image so as to have a better quality than the surrounding area. Determining ROI is a very important step if there is a certain part of the digital image that is more important than others. The first part in determining ROI is the are cropping process. This step aims to reduce the size of the image to be processed so that the result will be more accurate. Figure 5 is the result of cropping.

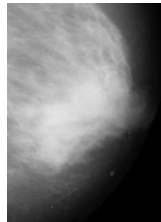

Fig. 5. Image after cropping

Next is to separate the light intensity with the Otsu method. Otsu thresholding separate the background and foreground by getting the value of each gray level variance. In this research, we used Otsu = 5. This method is more optimal than the Global thresholding method because of the way it works is to maximize the variance between classes.

The variance between these classes is suitable to statistically analyze class discriminant. The results of this phase is shown in Figure 6.

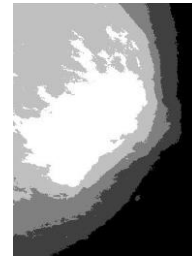

Fig. 6. Image after the separation of light intensity with Otsu=5

Then take an area that has estimated abnormalities by whitening the area which is regarded as normal. Black areas are considered as areas that are suspected of being cancerous abnormalities. This step is also called converting the image to binary. Figure 7 is the result of converting the image to binary phase.

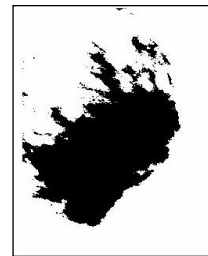

Fig. 7. Image after the phase of converting the image to binary.

The next step is segmentation. The purpose of image segmentation is to divide the image into a number of regions (areas) and separate an area that is estimated to show abnormalities. The estimated area is the one that has a stronger / brighter white color intensity than its surrounding, has a nearly uniform density, has a regular shape with various sizes, and its boundaries are blurred. Segmentation used in this study is the Region Growing segmentation method based on the resulted image from the determination of the ROI (cropping) step. Region Growing Segmentation is a segmentation method based on region. The principle of this method starts from a set of seed points, and initiate an initial region of the seed. This region will continue to grow from seed points to a collection of points adjacent to each other according to criteria. The result of the segmentation process can be seen in Figure 8.

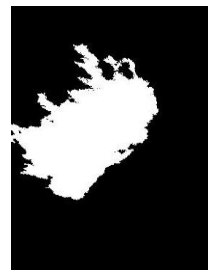

Fig. 8. Image after segmentation step.

Then calculate the area size of suspected abnormality found on the mammogram image resulted from segmentation with Region Growing method. At the time of the segmentation process, the image produced is a binary image of 0 and 1. Area 0 describe the normal area, marked with black. Area 1 illustrates the suspected area of cancer, marked with white. Calculation of area size 0 and 1 is generated in pixels. Values obtained from this process is based on the unit pixels.

After that, set the area pattern which aims to determine the pattern of suspected abnormalities to distinguish areas with suspected cancer from normal area. The next process is performed to detect the edge of the area, detecting the presence of edges of the suspected cancer area. This detection is useful for displaying the area borderline more clearly. Edge detecting method performed in this study is the Canny method, and the result is as shown in Figure 9. This method was chosen because it is able to produce a boundary edge more detailed than any other method.



Fig. 9. Image after edge detection (thin line).

Resulted image of Canny edge detection has a thin line. This causes a line that is not clear and dotted. To make it thicker conducted dilation process as shown in Figure 10.

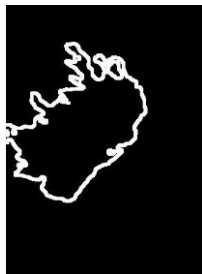

Fig. 10. Image after dillation process.

The next step is the incorporation of the image of the cropped area with the image resulted from dilation, and blacken the line resulted from edge detection. Both aim for the

clear vision of the position of suspected areas with abnormalities. The results of these two processes can be seen in Figure 11 (a) and (b).



Fig. 11. (a) Image after the joining step of the cropped and dilation results. (b) Image after the blackening step of the edge.

As the last step is the mammogram image classification. This step aims to classify the mammogram image, whether the image is suspect of breast cancer stage I, II, or III. Stage IV is not used as in the basis of the theory used, patients in stage IV have cancers that vary in size and has spread to several parts of the body so that further examination is needed. In this research, the classification method used is based on the results of the mammogram image segmentation of 33 samples with Region Growing method.

Segmentation results from this method produce an area suspected of cancer. The area size is calculated in units of pixels. The measures are grouped into 3 major groups using K - Means clustering method. The clustering results reflect the 3 group stage, i.e. stage I, II, and III. Each group size has a lower limit and upper limit that are used as a reference to determine the stage of cancer in which the application is made

#### IV. RESULT

In this research, 33 malignant mammogram images from MIAS database are used, where 12 images are from the group of malignant mammogram dense-glandular, 7 malignant mammogram images derived from fatty group and 14 malignant mammogram images derived from fatty-glandular groups.

After the process of segmentation, object area suspected breast cancer malignant from each group malignant mammogram will be obtained. K-Means Clustering is used to classify the object area suspected breast cancer into 3 stages. Stage 1 has size of the area between 3000 to 35000 pixel. Stage 2 has size of the area between 35000 to 85000 pixel. Stage 3 has size of the area between 85000 to 250000 pixel. Table 1 show the result of determining cancer stadium sample malignant mammogram image

TABLE I. THE RESULTS OF DETERMINING CANCER STADIUM FROM SAMPLE MALIGNANT MAMMOGRAM IMAGE.

No.	Mammogram Image	Group	Area Size (Pixels)	Stadium
1	mdb023.pgm	Dense-grandular	20052	Stadium I
2	mdb028.pgm	Dense-grandular	6850	Stadium I
3	mdb058.pgm	Dense-grandular	67754	Stadium II
4	mdb072.pgm	Dense-grandular	24205	Stadium I
5	mdb090.pgm	Dense-grandular	58623	Stadium II
6	mdb092.pgm	Dense-grandular	25521	Stadium I
7	mdb095.pgm	Dense-grandular	30294	Stadium I
8	mdb105.pgm	Dense-grandular	137669	Stadium III
9	mdb110.pgm	Dense-grandular	74595	Stadium II
10	mdb111.pgm	Dense-grandular	30065	Stadium I
11	mdb115.pgm	Dense-grandular	46132	Stadium II
12	mdb117.pgm	Dense-grandular	9333	Stadium I
13	mdb120.pgm	Fatty	48937	Stadium II
14	mdb124.pgm	Fatty	58808	Stadium II
15	mdb130.pgm	Fatty	83938	Stadium II
16	mdb134.pgm	Fatty	4772	Stadium I
17	mdb171.pgm	Fatty	135946	Stadium III
18	mdb178.pgm	Fatty	3470	Stadium I
19	mdb184.pgm	Fatty	19414	Stadium I
20	mdb202.pgm	Fatty-grandular	3558	Stadium I
21	mdb206.pgm	Fatty-grandular	20445	Stadium I
22	mdb209.pgm	Fatty-grandular	34093	Stadium I
23	mdb211.pgm	Fatty-grandular	37749	Stadium II
24	mdb213.pgm	Fatty-grandular	29616	Stadium I
25	mdb216.pgm	Fatty-grandular	156059	Stadium III
26	mdb233.pgm	Fatty-grandular	38599	Stadium II
27	mdb239.pgm	Fatty-grandular	154402	Stadium III
28	mdb241.pgm	Fatty-grandular	48011	Stadium II
29	mdb249.pgm	Fatty-grandular	49609	Stadium II
30	mdb253.pgm	Fatty-grandular	209699	Stadium III
31	mdb265.pgm	Fatty-grandular	47321	Stadium II
32	mdb267.pgm	Fatty-grandular	14508	Stadium I
33	mdb271.pgm	Fatty-grandular	4998	Stadium I

Based on the test of 33 samples of the malignant mammogram image, showed that: 48.5% are detected as stage I, stage II 36.37% detected and detected stage III 15.15%. In the dense-grandular group, 58.3% are detected as stage I, stage II 33.3% and detected stage III 8.33%. In the fatty group, 42,9% are detected as stage I, stage II 42.9% and detected stage III 14.2%. In the fatty-grandular group, 42.3% are detected as stage I, stage II 35.7% and detected stage III 21.4%.

#### V. CONCLUSION

The paper presented sample k-means clustering method for determining the stage of breast cancer malignancy based on cancer size on mammogram image basis. Previously done the

process of determining ROI with Otsu method and segmentation with region growing. The method is tested on 33 mammograms in 3 groups of malignant in MIAS database. The result, system can determine the stage of breast cancer based on the size of the area of the suspected object. The further work may be develop stage of breast cancer based on patern of mallignant

#### REFERENCES

- [1] American Cancer Society, "Breast Cancer Facts & Fig. s, 2013-2014", American Cancer Society, Inc, 2013.
- [2] Acha, B., Rangayyan, R.M., Desautels, J.E.L., "Detection of Microcalcifications in Mammograms", In: Suri, J.S., Rangayyan, R.M. (eds.) Recent Advances in Breast Imaging, Mammography, and Computer-Aided Diagnosis of Breast Cancer. SPIE, Bellingham, 2006.
- [3] Highnam R and Brady M, "Mammographic Image Analysis", Kluwer Academic Publishers, British Journal of Radiology, 74(887), 2001.
- [4] Maitra, I.K., Nag S., Bandyopadhyay S.K., "Identification of Abnormal Masses in Digital Mammography Images", International Journal of Computer Graphics, 2(1), 2011.
- [5] Bozek, J., Mustra, M., Delac, K., and Grgic, M., "A Survey of Image Processing Algorithms in Digital Mammography", Multimedia Signal Processing and Communications Studies in Computational Intelligence Volume 231, 2009, pp 631-657.
- [6] Yasmin, M., Sharif, M., and Mohsin, S., "Survey Paper on Diagnosis of Breast Cancer Using Image Processing Technique", Research Journal of Recent Sciences, Vol. 2(10), 88-98, October 2013.
- [7] American Joint Committee on Cancer, "Breast Cancer Staging", AJCC 7th Edition Staging Posters, 2009.
- [8] Pradeep, N., Girisha, H., Sreepathi, B., and Karibasappa, K., "Feature Extraction of Mammograms", International Journal of Bioinformatics Research, Volume 4, Issue 1, 2012, pp.-241-244.
- [9] Sezgin, M., and Sankur, B., "Survey over image thresholding techniques and quantitative performance evaluation". Journal of Electronic Imaging ,13 (1): 146–165. 2004.
- [10] Maitra, I.K., Nag S., Bandyopadhyay S.K., "A Novel Edge Detection Algorithm for Digital Mammogram", International Journal of Information and Communication Technology Research, Vol 2 No.2, February 2012.
- [11] Kamdi, S., "Image Segmentation and Region Growing Algorithm", International Journal of Computer Technology and Electronics Engineering (IJCTEE), Vol 2 Issue no.1, October 2011.
- [12] Priya, D.S., and Sarojini, B., "Breast Cancer Detection In Mammogram Images Using Region-Growing And Contour Based Segmentation Techniques", International Journal of Computer & Organization Trends, Vol.3 Issue 8, September 2013.
- [13] Martins, L.d.O., Junior, G.B., Silva, A.C., Paiva, A.C. and Gattass, M., "Detection of Masses in Digital Mammograms using K-Means and Support Vector Machine", Electronic Letters on Computer Vision and Image Analysis 8(2) : 39-50, 2009.
- [14] Suckling, J., "The Mammographic Image Analysis Society Digital Mammogram Database", Exerpta Medica, International Congress 1069, pp 375-378, 1994.

# Bipolar Factor and Systems Analysis skills of Student Computing Professionals at University of Botswana, Gaborone.

Ezekiel U. Okike

Department of Computer Science  
University of Botswana  
Gaborone, Botswana

**Abstract**—Temperamental suitability (personality traits) could be a factor to consider in career placement and professional development. It could also be an indicator of professional success or failure in any profession such as Systems Analysis and Design (SAD). However, there is not sufficient empirical evidence in support of the personality traits to which systems analysts and designers may be categorized. The objective of this study is to empirically investigate the main personality traits to which systems analysts and designers may belong, then propose a new approach to composing a personality matrix based on sound computational model. The study employed a quantitative research approach to measure the personality traits of 60 student systems analysts and designers using a human metric tool such as the Myers Briggs Type Indicator (MBTI) and some pre designed additional questionnaires. A mathematical model of the form  $\alpha_{ij} = \beta_0 + \beta_1 x_{1j} + \beta_2 x_{2j} + \beta_3 x_{3j} + \beta_4 x_{4j} + \dots + \beta_n x_{nj}$  was employed in order to measure achievement in systems analysis and design examination. The Statistical Package for the Social Sciences (SPSS) was used to analyse the data. Using linear regression, the model was not significant, implying that achievement in SAD examination does not depend only on personality traits, motivation variables and study habit variables which were the independent variables. However, the R squared value indicated that these variables account for 52% variation in the dependent variable SAD score (achievement). The best achievers in the personality traits are ENFJ, ENTJ, ISFJ and INFJ all scoring 70% each. Therefore, the best achievers possess the personality traits of extroversion (E), iNtuition (N), Feeling (F), Judging (J), Thinking (T), Introversion (I), Sensing (S). Overall, the highest passes are students of the traits INFJ (11), INTJ (11 passes), ENTJ (10 passes), ENFJ (10 passes), ESFP (3passes), ISFJ (3passes), ISTJ (3 passes), ESFP (2 passes), ENFP (1), ISTP (1), and ISFP (1).

**Keywords**—personality trait; systems analysts; academic achievement; bipolar matrix

## I. INTRODUCTION

The term computing professionals encompasses professionals in Computer Science (CS), Computer Engineering (CE), Software Engineering (SE), Information Technology (IT), and Information Systems (IS). Systems Analysis and Design (SAD) is the professional practice of trained systems analysts whose main duty is to seek to understand what humans need to analyse data input or data flow systematically, to process or to transform data, and to

store data and output information in the context of a particular business [10]. This professional skill could be the specialization of any computing professional depending on interest. Like any other professional practice, the systems analyst must possess certain qualities and skills which can only be acquired by appropriate formal education and training. Students enrolled in the Systems Analysis and Design (SAD) course offered at the undergraduate level at the University of Botswana, Gaborone are the focus of this study. The University of Botswana, Computer Science Department has different cluster groups identified by the following programmes: Bachelor of Computer Science (BSC 280), Bachelor of Information Technology (BSC 204), and Bachelor of Information Systems (BIS 210), and Bachelor of Computing with finance (BSC 205). All clusters take SAD as a core course at 300 levels. The main objectives of the SAD course among others are to teach students to:

- Identify systems, roles, elements and the need for Systems Analysts
- be able to investigate systems
- be able to manage Information system projects
- be able to use appropriate methodologies, techniques and technologies in analysing designing, implementing and maintaining usable software systems

Temperamental suitability is one of the factors usually considered in career placement and professional development [4]. It can also be an indicator of professional success or failure in such profession as systems analysis and design [1, 2,3]. Using an automated human metric tool based on Myers Brigg's Type indicator (MBTI), the personality traits of individuals may be analysed.

The tool classifies individual personality traits using 16 categories namely Introversion Sensing Thinking Judging (ISTJ), Introversion Sensing Feeling Judging (ISFJ), Introversion Sensing Thinking Perceiving (ISTP), Introversion Sensing Feeling Perceiving (ISFP); Introversion iNtuition Feeling Judging (INFJ), Introversion iNtuition Thinking Judging (INTJ), Introversion iNtuition Feeling Perceiving (INFP), Introversion iNtuition Thinking Perceiving (INTP); Extraversion Sensing Thinking Perceiving (ESTP), Extraversion Sensing Feeling Perceiving (ESFP), Extraversion Sensing Thinking Judging (ESTJ), Extraversion Sensing



Feeling Judging (ESFJ); Extraversion iNtuitioN Feeling Perceiving (ENFP), Extraversion iNtuitioN Thinking Perceiving (ENTP), Extraversion iNtuitioN Feeling Judging (ENFJ), and Extraversion iNtuitioN Thinking Judging (ENTJ).

The bipolar factor or dimension was introduced in Jung's Theory of Psychological Types and identified as Jung's dichotomies or poles representing opposite preferences [6,8,12]. The combined Jung and Myers Briggs parameters representing the bipolar dimensions in human personality are:

- 1) *Extroversion (E) and Introversion (I)*
- 2) *Sensing (S) and iNtuitioN (N)*
- 3) *Thinking (T) and Feeling (F)*
- 4) *Judging (J) and Perceiving (P)*

Using the four personality trait pairs above, and performing all possible permutations on the traits yield the 16 different personality types ESTJ, ESTP, ESFJ, ESFP, ISTJ, ISTP, ISFJ, ISFP, ENTJ, ENTP, ENFJ, ENFP, INTJ, INTP, INFJ, INFP as defined above.

### B. Problem Statement

Personality trait is a critical factor in determining career success as certain personality trait have been known to enhance job performance [1,2,4]. In the field of systems analysis and design however, there is not sufficient empirical evidence as to which personality traits successful and skilled systems analysts are categorized. This study is an attempt to contribute empirical solution to the problem of paucity of empirical evidence in support of personality trait categorization of systems analysts and designers.

### C. Study Objectives

The main objective of this study is to empirically investigate the main personality indicators of good systems analysts and designers using trainee student analysts and designers. The study is also used to propose and demonstrate a new approach to compose personality matrix based on sound and convincing computational model.

### D. Research Questions

The following research questions are investigated in this study.

- What are the personality traits of systems analysts and designers?
- Is personality a factor to be considered in the choice of systems analysis and design as a career?
- Do computing professionals such as systems analysts and designers (and programmers) have distinctive personalities?

### E. Research Hypotheses

The following hypotheses are tested in this study:

H0: Introverts will have higher achievement in Systems analysis and design than extroverts

H1: Introverts will not have higher achievements than extroverts in systems analysis and design

H0: Sensors will have higher achievement in Systems analysis and design than intuitives

H1: Sensors will not have higher achievements than intuitives in systems analysis and design

H0: Thinkers will have higher achievement in Systems analysis and design than feelers

H1: Thinkers will not have higher achievements than feelers in systems analysis and design

H0: Judges will have higher achievement in Systems analysis and design than Perceivers

H1: Judges will not have higher achievements than perceivers in systems analysis and design

H0: There is significant correlation between personality traits and achievement in systems analysis and Design examination

H1: There is no correlation between personality traits and achievement in systems analysis and design examinations

The rest of this paper is divided into 6 sections. Section 2 is a review of relevant literature. Section 3 explains the research methodology. Section 4 presents the result of this study with appropriate discussion. Section 5 is the conclusion while section 6 is the list of references

## II. LITERATURE REVIEW

Previous studies have looked at personality as indicators of success or failure in the fields of computer programming and software engineering [1, 2, 3]. Bentley [4] reviewed personality traits and programmer characteristics and presented some of the traits that can be indicators of success or failure in computer programming. Weinberg [13] explored the psychology of computer programming and noted that there could be variations in individual productivity due to personality type factor. Capretz [6] investigated personality types of software engineers based on the combined Jung and Myers Briggs bipolars. The study suggested that they were more (Introvert Sensing Thinking Judging (ISTJ) software engineers than other types in his data. Furthermore, Capretz [2] suggested that people possessing personality traits extrovert and feeling might be preferred when appointing systems analysts. Turley and Bieman [12] studied the attributes of individual software developers in order to identify their professional competencies using biography data and Myers- Briggs Type Indicator (MBTI) and concluded that there was no simple predictor of performance. Although experience variables in their study were related to performance, it could only predict classification of exceptional and non-exceptional of 63% of the subjects.

Chung [7] studied the cognitive abilities in computer programming using 523 Form Four secondary school students in Hong Kong. Test administered to the students included mathematics, space, symbols, hidden figures and programming ability. Results of the study suggest that performance in mathematics and spatial tests were significant predictors in programming ability. Similarly, Bishop-Clark and Wheeler [5] investigated the Myers-Briggs personality

type and its relationship to computer programming. Using 114 students, the study sought to know if college students with certain personality types performed better than others in an introductory programming course. In Bishop-Clark and Wheeler [5] study, results suggest that sensing students performed significantly better than intuition students in programming assignments while judging students performed better than perception students on computer programs although the results were not significant statistically.

Irani, Telg, Scherler, and Harrington [9] studied the relationship between personality type and distance education students course perception and performance using 39 graduate students of distance education. Results of the study indicate that of the MBTI type preferences, only thinking and perceiving types showed no significant correlations between course perceptions and performance indicators. The study concludes that performance outcomes for distance education students may be closely related to course perceptions as a function of personality type preference. Perceptions of instructional technique used by the distance instructor were strongly correlated to the students' course grade and overall grade point average for the following personality types: extravert, introvert, intuitive, sensing, feeling, and judging.

Da Cunha and Greathead [8] investigated if a specific personality type is correlated with performance on code review task. The subjects of study were 64 second year undergraduate students at New Castle University, UK. To examine the possible links with MBTI type and code review ability, the researchers computed some correlations between task score and each bipolar factor Extrovert-Introvert (EI), Sensing-iNtuition(SN), Thinking-Feeling(TF) and Judging-Perceiving(JP). The result of the study indicates that only a single bipolar within the SN bipolar significantly correlated with code review task, suggesting that people more intuitively inclined performed better than others on code review.

### III. STUDY METHODOLOGY

The study uses a quantitative research approach to measure the personality traits or attributes of 60 student computing professionals who registered for the System Analysis and Design (SAD) course (CSI 342) in the first semester of 2013/2014 session at the University of Botswana, Gaborone.

A human metric tool (Myers Brigg's Type Indicator, MBTI) was administered on 60 third year students taking Systems Analysis and Design course (CSI 342) at the University of Botswana. The students were drawn from those majoring in the programmes: Bachelor of Information Technology (BSC204), Bachelor of Computing with finance (BSC 205), Bachelor of Computer Science (BSC280), Bachelor of Information System (BIS 210) and Bachelor of Education, Computer Science option (BED 240) programmes of study. The MBTI tool classified the 60 students according to their individual personality traits.

Furthermore, additional questionnaires were designed in order to gather information from the students concerning what motivated their choice of programme of study at the University of Botswana (UB): BSC204, BSC 205, BSC 280, BIS 210 and BED 240. Additional questionnaires also sought

to gather information on how the students study to understand the SAD course they take at the university. In order to measure achievement in Systems Analysis and Design, a model was used as follows:

$$\alpha_{ij} = \beta_0 + \beta_1 x_{1j} + \beta_2 x_{2j} + \beta_3 x_{3j} + \beta_4 x_{4j} + \dots + \beta_n x_{nj}$$

Where  $\alpha_{ij}$  represents a dependent variable, and the independent variables are represented as  $\beta_0 + \beta_1 x_{1j} + \beta_2 x_{2j} + \beta_3 x_{3j} + \beta_4 x_{4j} + \dots + \beta_n x_{nj}$ . The dependent variable in this study is a student's performance or score in Systems Analysis and Design; the independent variables are the various personality traits exhibited by a student in terms of the level (in percentages) of Extroversion, Introversion, Thinking, Feeling, Sensing, iNtuition, Judging and Perceiving.

The variables which influenced students' choice of programme of study include: parental influence, personal desire to be in the computing profession, students ability in science and mathematics, students ability in science without mathematics, other reasons; and the variables which indicate student study habit : reading of text books, reading only class notes, reading from online lecture notes (module), use of internet materials, use of university library to read text books and other relevant materials, none use of university library, going to university library to read personal materials; reading class notes, text books and online lecture notes; reading class notes and online lecture materials only because student don't have enough money to purchase recommended text; any other reasons were also considered as independent variable. Data analysis was performed on the data using the Statistical Package for the social sciences (SPSS). Linear regression was done in order to fit the model and justify its significance or none significance at the 0.05 level of significance. The result of regression model was also used to determine the impact of the independent variable on student's performance.

### IV. RESULT AND DISCUSSION

#### A. Model Fitting

The model  $\alpha_{ij} = \beta_0 + \beta_1 x_{1j} + \beta_2 x_{2j} + \beta_3 x_{3j} + \beta_4 x_{4j} + \dots + \beta_n x_{nj}$  was tested for fitness using regression statistic. The result as shown in Table 1 (a, b) suggests that the model is not significant. However, the R square of 52% implies that about 52% of the predictors explain the variations in the dependent variable. This means that the personality traits contribute to achievement in CSI 342: Systems Analysis and Design.

a) *Dependent Variable: CSI342*

b) *Predictors in the Model:*

(Constant), PERCEIVING, THINKING, INTRVERT, INTUITIVE, SENSING, FEELING

TABLE I. (A): MODEL SUMMARY

Model	R	R Sqr	Adjustd R Sqr	Std Error of The estimate
1	.227 <sup>a</sup>	.052	-.056	7.83561

a. Predictors: (Constant), PERCEIVING, THINKING, INTRVERT, INTUITIVE, SENSING, FEELING

TABLE I. (B): ANOVA<sup>A</sup>

Model	Sum of Sqr.	df	Mean Sq	F	Sig
1	176.702	6	29.450	.480	.820 <sup>b</sup>
Regrsion	3254.031	53	61.397		
Residual	3430.733	59			
Total					

B. Analysis of Students Systems Analysts and Designers by Programme of Study

Table 2 below shows the frequencies for Student Systems Analysts and Designers by programme of study.

TABLE II. PROGRAMME OF STUDY

	Frequency	Percent	Valid %t	Cumulative %
BSC204	14	23.3	23.7	23.7
BSC205	17	28.3	28.8	52.5
BSC280	27	45.0	45.8	98.3
BIS210	1	1.7	1.7	100.0
Total	59	98.3	100.0	
Missing System	1	1.7		
Total	60	100.0		

BSC 204 Bachelor of Information Technology

BSC 205 Bachelor of Computing with Finance

BSC 280 Bachelor of Computer Science

BIS 210 Bachelor of Information systems

BED 240 Bachelor of Science Education (Computer Science)

C. Analysis of Students Systems Analysts and Designers by Personality Trait

Table 3 below shows the frequency distribution of students Systems Analysts and Designers by personality types. A distribution of the traits by programme of study is shown in Table 4.

TABLE III. PERSONALITY TYPE

	Frequency	Percent	Valid %	Cum %
ENTJ	10	16.7	16.7	16.7
ENFJ	10	16.7	16.7	33.3
ENFP	1	1.7	1.7	35.0
ESFJ	3	5.0	5.0	40.0
ESFP	2	3.3	3.3	43.3
ISFJ	4	6.7	6.7	50.0
ISTJ	4	6.7	6.7	56.7
ISTP	1	1.7	1.7	58.3
INFJ	12	20.0	20.0	78.3
INTJ	12	20.0	20.0	98.3
ISFP	1	1.7	1.7	100.0
Total	60	100.0	100.0	

D. Analysis of Students Systems Analysts and Designers by Personality traits

TABLE IV. DISTRIBUTION OF PERSONALITY TRAIT BY COMPUTING PROGRAMME OF STUDY

Trait	BSC204	BSC205	BSC280	BIS210	BED240
ENTJ	3	4	2		1
ENFJ	5	3	2		
ENFP			1		
ESFJ			3		
ESFP	2				
ISFJ	1	2			
ISTJ		1	4	1	
ISTP			1		
INFJ	1	6	5		
INTJ	1	1	10		
TOTAL	13	17	28	1	1

E. Bipolar Factor Analysis of Students Systems Analysts and Designers

Tables 5 - 12 present the frequency distribution of students' Systems Analysts and Designers by considering the level (in percentages) of each recognizable personality trait: extraversion, introversion, thinking, Judging, Sensing, iNtuition, Feeling, and Perceiving. Interestingly, this is still along the bipolar dimensions of human personality. The tables enable the construction of a personality matrix upon which the dominant personality traits of Student systems Analysts and Designers are constructed as shown in Table 13.

TABLE V. EXTROVERT (E)

E %	Frequency	Percent	Valid %	Cum %
.00	34	56.7	56.7	56.7
1.00	6	10.0	10.0	66.7
6.00	1	1.7	1.7	68.3
11.00	6	10.0	10.0	78.3
22.00	5	8.3	8.3	86.7
Valid 33.00	3	5.0	5.0	91.7
44.00	2	3.3	3.3	95.0
56.00	1	1.7	1.7	96.7
63.00	1	1.7	1.7	98.3
67.00	1	1.7	1.7	100.0
Total	60	100.0	100.0	

TABLE VIII. FEELING (F)

F%	Frequency	Percent	Valid %	Cum %
.00	26	43.3	43.3	43.3
1.00	1	1.7	1.7	45.0
12.00	11	18.3	18.3	63.3
25.00	10	16.7	16.7	80.0
Valid 38.00	6	10.0	10.0	90.0
44.00	1	1.7	1.7	91.7
50.00	4	6.7	6.7	98.3
62.00	1	1.7	1.7	100.0
Total	60	100.0	100.0	

TABLE VI. INTROVERT (I)

Frequency	Percent	Valid %	Cum %
26	43.3	43.3	43.3
4	6.7	6.7	50.0
3	5.0	5.0	55.0
5	8.3	8.3	63.3
4	6.7	6.7	70.0
2	3.3	3.3	73.3
1	1.7	1.7	75.0
12	20.0	20.0	95.0
1	1.7	1.7	96.7
2	3.3	3.3	100.0
60	100.0	100.0	

TABLE IX. SENSING(S)

S%	Frequency	Percent	Valid %	Cum %
.00	46	76.7	76.7	76.7
1.00	8	13.3	13.3	90.0
12.00	2	3.3	3.3	93.3
Valid 19.00	1	1.7	1.7	95.0
25.00	1	1.7	1.7	96.7
38.00	1	1.7	1.7	98.3
48.00	1	1.7	1.7	100.0
Total	60	100.0	100.0	

TABLE VII. THINKING (T)

T%	Frequency	Percent	Valid %	Cum %
.00	34	56.7	56.7	56.7
1.00	10	16.7	16.7	73.3
12.00	3	5.0	5.0	78.3
Valid 25.00	4	6.7	6.7	85.0
31.00	3	5.0	5.0	90.0
50.00	5	8.3	8.3	98.3
75.00	1	1.7	1.7	100.0
Total	60	100.0	100.0	

TABLE X. INTUITION (N)

N%	Freq	Percent	Valid %	Cum %
.00	15	25.0	25.0	25.0
1.00	1	1.7	1.7	26.7
12.00	6	10.0	10.0	36.7
25.00	9	15.0	15.0	51.7
Valid 31.00	1	1.7	1.7	53.3
38.00	11	18.3	18.3	71.7
50.00	11	18.3	18.3	90.0
62.00	5	8.3	8.3	98.3
75.00	1	1.7	1.7	100.0
Total	60	100.0	100.0	

TABLE XI. JUDGING (J)

J%	Frequency	Percent	Valid %	Cum %
.00	5	8.3	8.3	8.3
1.00	2	3.3	3.3	11.7
11.00	6	10.0	10.0	21.7
17.00	1	1.7	1.7	23.3
22.00	8	13.3	13.3	36.7
33.00	7	11.7	11.7	48.3
Valid 44.00	10	16.7	16.7	65.0
50.00	1	1.7	1.7	66.7
56.00	6	10.0	10.0	76.7
67.00	8	13.3	13.3	90.0
78.00	5	8.3	8.3	98.3
89.00	1	1.7	1.7	100.0
Total	60	100.0	100.0	

TABLE XII. PERCEIVING (P)

P%	Frequency	Percent	Valid %	Cum %
.00	56	93.3	93.3	93.3
11.00	1	1.7	1.7	95.0
22.00	1	1.7	1.7	96.7
Valid 50.00	1	1.7	1.7	98.3
56.00	1	1.7	1.7	100.0
Total	60	100.0	100.0	

Extracts from these Tables 5- 12 were used to construct a personality matrix table as shown in Table 13

TABLE XIII. PERSONALITY FREQUENCY MATRIX

Personality Type	Type Indicator	N
Extroversion (E) Introversion (I)	EI	60
Sensing (S) iNtuition (N)	SN	59
Thinking (T) Feeling (F)	TF	60

26	34	60	60
Judging (J)	Perceiving(P)	JP	60
55	4	59	

From Table 13, the dominant or prominent personality traits of Students Systems Analysts and Designers may be calculated as follows:

Judging (J) = 55, iNtuition (N) = 45, Introversion (I) = 34, and Feeling = 34 (F). This gives the trait INFJ. Furthermore, Extroversion (E) =26, Thinking (T) = 26. Hence the traits INTJ, ENFJ, ENTJ are also dominant. This is further supported by Table 2 (personality type). So, for these set of Systems Analysts, the traits INFJ, INTJ, ENFJ, ENTJ are very important indicators or attributes. Therefore, the most common valid personality attributes of systems analysts and designers here are Extroversion (E), Introversion (I), Feeling (F), iNtuition (N) Judging (J) and Thinking as shown in Table 13 above. However, the best achievers are not necessarily the dominant traits in a set (see section 4.6).

F. Type Matrix Construction

Arising from tables 13, a type matrix modelling table was constructed as shown in Table 14 (a, b). The table was composed by adding each bipolar to get the type indicator value which sum up to N, the class size in Table 13. However, the type indicator is not bound to sum up to N. Diagonals of the Table 14 must add up to the type indicator of Table 13, otherwise Table 14 (a) must be resized as shown in Table 14 (b).

TABLE XIV. (A) TYPE MATRIX TABLE

E 26	I 34	S 14	N 45
26 T	34 F	55 J	4 P

Resize

TABLE XIV. (B) TYPE MATRIX TABLE (NORMALIZED)

E 60	F 34	N 45	P 4
26 T	34 I	55 J	14 S

G. Achievement in Systems Analysis and Design Examination and Personality Type

TABLE XV. (A). SYSTEMS ANALYSIS EXAM AND PERSONALITY TYPE

Score %	PTYPE							Total
	E	E	E	E	E	IS	ISTJ	
Pass ≥ 50%	NTJ	NFJ	NFP	SFJ	SFP	FJ		
39.00	0	0	0	0	0	1	0	
41.00	0	0	0	0	0	0	0	
44.00	0	0	0	0	0	0	1	
45.00	0	0	0	0	0	0	0	
50.00	1	1	0	1	1	0	0	
51.00	0	0	0	0	0	0	1	
52.00	1	0	1	0	0	0	0	
53.00	1	1	0	0	0	0	0	
54.00	2	1	0	0	0	0	0	
56.00	0	1	0	0	0	1	1	
57.00	1	0	0	1	1	0	0	
58.00	0	0	0	0	0	0	0	
59.00	0	0	0	0	0	0	0	
60.00	1	1	0	0	0	1	0	
61.00	0	0	0	0	0	0	0	
62.00	0	0	0	0	0	0	1	
63.00	0	2	0	0	0	0	0	
64.00	0	0	0	0	0	0	0	
65.00	1	0	0	0	0	0	0	
67.00	0	0	0	1	0	0	0	
68.00	1	1	0	0	0	0	0	
70.00	1	2	0	0	0	1	0	
Total	10	10	1	3	2	4	4	

H. Comparisons Between Personality characteristics and Systems Analysts Characteristics

a) Characteristics of various types

Extraversion (E): Focus on the outer world

Introversion (I): Focus own inner world

TABLE XV. (B) SYSTEMS ANALYSIS EXAMS AND PERSONALITY TYPE

Score %	PTYPE				Total
	ISTP	INFJ	INTJ	ISFP	
39.00	0	0	0	0	1
41.00	0	1	0	0	1
44.00	0	0	0	0	1
45.00	0	0	1	0	1
50.00	0	2	4	0	10
51.00	0	2	1	0	4
52.00	0	1	0	0	3
53.00	0	1	0	0	3
54.00	0	0	0	0	3
56.00	0	0	2	0	5
57.00	0	1	0	0	4
58.00	0	1	0	0	1
59.00	1	0	1	0	2
60.00	0	0	0	0	3
61.00	0	0	1	0	1
62.00	0	1	0	0	2
63.00	0	0	0	1	3
64.00	0	0	1	0	1
65.00	0	0	0	0	1
67.00	0	0	0	0	1
68.00	0	1	1	0	4
70.00	0	1	0	0	5
Total	1	12	12	1	60

Feeling (F): When making decisions, they look at the people and special circumstances

iNtuition (N) : Interpret and add meaning to information they taken in

Judging (J): In dealing with outside, they get things decided

Thinking (T): When making decisions they first look at the logic and consistency

b) Essential qualities and skills of Systems analysts and designers



Kendall [10] identified three essential qualities most systems analysts seem to display, namely:

- The analyst as a problem solver possesses the ability to tackle situation at hand through the application of essential tools, techniques and experience
- The analyst as a good communicator, with the ability to relate well with others which enhances his understanding of human needs with respect to use of technology and information systems
- The analyst as a possessor of strong personal and professional ethics which helps them have self-discipline, self-motivation and shape their relationship with others.

Tegarden, Dennis and Wixon [11] on the other hand identified the six essential skills of systems analysts to include:

- Technical skills. Analysts must have technical skills to understand organizational technologies
- Business skills. Analysts need business skills to enhance their understanding of how Information Technology (IT) can be applied to deliver business solutions
- Analytical skills. Analysts need analytical skills as problem-solvers to address project and organizational challenges
- Interpersonal skills. Analysts need interpersonal skills in their relationship with stakeholders which require that they effectively communicate with each other.
- Management skills. Analysts have the ability to manage projects and resources.
- Ethical skills. Honesty with team members and the ability to maintain appropriate confidentiality is expected of all analysts.

### I. Discussion

A careful comparison of the systems analysts characteristics and the personality characteristics suggests that the analyst presumably could possess any of the personality characteristics especially the Feeling, iNtuition, Judging and Thinking. From Table 2, the dominant personality traits from the subject of this study are INFJ (12), INTJ (12), ENTJ (10), and ENFJ (10). However, these trait groups are not necessarily the best achievers in systems analysis and design examination. This is easily verified from Tables 13 and Table 15 (a, b) which show the performance of various personality traits in systems analysis and design examination. The best achievers in the personality traits are ENFJ, ENTJ, ISFJ and INFJ all scoring 70% each. Hence, the best achievers possess the personality traits of extroversion, iNtuition, Feeling, Judging, Thinking, Introversion, Sensing. Overall, the highest passes

are INFJ (11) and INTJ (11 passes) supporting hypotheses 1,3,4, 5; ENTJ (10 passes) and ENFJ (10 passes) which nullifies hypothesis 2; ESFP(3passes), ISFJ (3passes), ISTJ (3 passes), ESFP (2 passes), ENFP (1), ISTP (1), ISFP (1).

In terms of correlations between achievement in SAD examination and personality traits, there is no significant relationship between personality traits and achievement in systems analysis and design examination. Although personality traits might contribute to academic achievement in systems analysis and design, it is not significant to influence achievement.

### J. Conclusion

In conclusion, systems analysts and designers may exhibit any of the bipolar personality traits especially the traits INFJ, INTJ, ENTJ, ENFJ, ISFJ, ISTJ, ESFP, ENFP, ISTP, ISFP in this order of priority (research question 1).

Personality is not a significant factor in the choice of systems analysis and design as a career (research question 2). Individuals do have distinctive personalities which do enhance their performance in certain tasks, including systems analysis and design (research question 3)

### REFERENCES

- [1] A. S. Sodiya, H. O. D Longe, S. A. Onashoga, O. Awodele and L. O. Omotosho, "An improved assessment of personality traits in Software Engineering," *Interdisciplinary Journal of Information, Knowledge, and management*, vol. 2, 2007.
- [2] F. Capretz, F. Ahmed, "Making sense of software development and personality types," *IPro*, vol. 12, no. 1 January/February 2010.
- [3] M. Omar, and S Syed-Abdullah, "Identifying effective software engineering (SE) team personality types composition using rough set approach," *IEEE* 2010
- [4] J. E. Bentley, "Laziness, impatience, hubris: personality traits of a great programmer," unpublished
- [5] C. Bishop-Clark and D. Wheeler, "The Myers-Briggs personality type and its relationship to computer programming," *Journal of Research on Computing in Education*. Vol. 26 Issue 3, pg. 358-371, 1994.
- [6] F. L. Capertz, "Personality types in Software Engineering," *Int. J. Human-Computer Studies*. 58, pp. 207-214, 2003.
- [7] C. Chung, "Correlates of problem solving in programming," *CUHK Educational Journal* Vol. 16. No. 2, pp.185-190, 1986.
- [8] D. A. Da Cunha, and D. Greathead, "Does Personality matter? An Analysis of code -review ability," *Communications of the ACM*. Vol. 50. No. 5, pp. 109-111, May 2007
- [9] T. Irani, R. Telg, C. Scherler, and M Harrington, "Personality type and its relationship to distance education students' course perceptions and performance," *Quarterly Review of Distance Education*; Vol. 4 Issue 4, p445, 2003.
- [10] E. K. Kendall, and J. E. Kendall, "Systems Analysis and Design," UK: Pearson, 2011, pp. 34-36.
- [11] D. Tegarden, A. Dennis, and H. B. Wixon, "Systems Analysis and Design with UML," 4th ed. Singapore: Wiley, 2013, pp. 20-22
- [12] R. T. Turley, and J. M. Bieman, "Competencies of exceptional and non-exceptional software engineers," *J. Systems Software*. 28:19-38
- [13] G. M. Weinberg, "The Psychology of Computer Programming, 2nd ed. Van Nostrand Reinhold: New York

# A Machine Learning Tool for Weighted Regressions in Time, Discharge, and Season

Alexander Maestre, Ph.D. P.E.

Dept. of Civil, Construction and Environmental Engineering  
The University of Alabama Tuscaloosa,  
Alabama. USA

Derek Williamson, Ph.D.

Dept. of Civil, Construction and Environmental Engineering  
The University of Alabama Tuscaloosa,  
Alabama. USA

Eman El-Sheikh, Ph.D.

Department of Computer Science  
University of West Florida Pensacola,  
Florida. USA

Amelia Ward, Ph.D.

Center for Freshwater Studies  
The University of Alabama Tuscaloosa,  
Alabama. USA

**Abstract**— A new machine learning tool has been developed to classify water stations with similar water quality trends. The tool is based on the statistical method, **Weighted Regressions in Time, Discharge, and Season (WRTDS)**, developed by the United States Geological Survey (USGS) to estimate daily concentrations of water constituents in rivers and streams based on continuous daily discharge data and discrete water quality samples collected at the same or nearby locations. WRTDS is based on parametric survival regressions using a jack-knife cross validation procedure that generates unbiased estimates of the prediction errors. One of the disadvantages of WRTDS is that it needs a large number of samples ( $n > 200$ ) collected during at least two decades. In this article, the tool is used to evaluate the use of **Boosted Regression Trees (BRT)** as an alternative to the parametric survival regressions for water quality stations with a small number of samples. We describe the development of the machine learning tool as well as an evaluation comparison of the two methods, WRTDS and BRT. The purpose of the tool is to evaluate the reduction in variability of the estimates by clustering data from nearby stations with similar concentration and discharge characteristics. The results indicate that, using clustering, the predicted concentrations using BRT are in general higher than the observed concentrations. In addition, it appears that BRT generates higher sum of square residuals than the parametric survival regressions.

**Keywords**—*Machine Learning; Boosted Regression Trees; Survival Parametric Regression; Water Quality Modeling; Weighted Regressions in Time; Discharge; and Season*

## I. INTRODUCTION

The United States Geological Survey (USGS) has developed linear models for predicting daily concentration of water constituents in rivers and streams using physical and temporal explanatory variables. The majority of these models are based on regressions that evaluate the correlation between observed concentrations and other variables including water discharge and time. Recently, a new model has been developed by the USGS to estimate daily concentrations using **Weighted Regressions in Time, Discharge, and Season (WRTDS)** [1]. Two main advantages of WRTDS include the possibility of conducting regressions with censored information (non-detects) using parametric survival regressions. In addition, WRTDS

uses a jack-knife cross validation approach that evaluates the importance of each survival regression by selecting subsets of the complete dataset. The cross validation approach is also used to identify trends of the constituent concentration in time.

WRTDS has been created by a series of routines written in R, a free package for statistical computing and graphics [2]. The statistical method estimates the concentration using two libraries: `dataRetrieval` and `EGRET`. The first library, `dataRetrieval` [3], automatically downloads existing records of water discharge and water constituent concentrations from a dedicated server. Approximately 14,500 parameters are available for download using the `dataRetrieval` tool. The list of parameters available in the server includes nutrients, pesticides, organics, and physical properties among others. The second library, `EGRET` [4], was created to explore and generate graphics associated with river concentration trends. `EGRET` conducts the parametric survival regressions and estimates daily concentrations in those periods when samples were not collected.

WRTDS has been tested in more than two dozen stations in the U.S. [1][5-11]. The use of this technique has become popular in recent years because it uses locally weighted regressions to estimate daily concentrations. During the regression process, WRTDS establishes the regression coefficients using only observed concentrations with similar discharge, season, and time to the day that is being estimated [9]. However, one of the restrictions of this method is that requires a large number of samples (minimum 200) collected at the specific station with daily water discharge records collected for at least 20 years without major gaps [1].

There are approximately 26,000 USGS stations installed throughout the U.S. A large percentage of these stations have long historical records of daily water discharge but only a few have more than the required 200 water quality samples. Fortunately, other agencies (including state and local environmental agencies) have been collecting additional water quality samples for several decades. The information collected by these agencies has been motivated by cities, non-profit organizations and communities to assess and manage the quality of rivers and streams.

Support from NSF EPSCoR EPS-1010607 and the 2013 USGS 104(G) Competitive Grants Program/Alabama Water Resources Research Institute (Project 2013AL156B).

Improvements on these water quality stations include the installation of real time stations. Currently there are approximately 1,700 stations in the U.S. that collect water discharge with a frequency of 15 minutes or less. The information collected by these stations can be downloaded automatically via Internet.

In this paper, we analyze the possibility of generating nitrate + nitrite-N concentration estimates in stations that have few samples. To achieve that, we generate a training data set with samples collected in stations with similar concentration and discharge characteristics and generate a Boosted Regression Tree (BRT). BRT is a non-parametric technique that successfully identifies the influence of the predictors in the response when the interaction occurs in a complex and non-linear way [12]. It has been used to investigate high variance traffic crash data in Taiwan [13], predict fishing effort distributions [14], and the identification of processes that drive the richness, composition, and occurrence of plants species in northwest Finland [15]. Machine learning methods using BRT have also been used to determine the best set of automatic methods for fine-tuning the code executed on the graphics processing unit (GPU) in different computer architectures [16]. Although BRT has been used for a variety of problems, no literature was identified on its use for water quality modeling. Our work reported in this paper on applying BRT to this problem is thus novel.

The selection of training set stations is obtained from an arbitrary set classified by a clustering algorithm. Once the subset of similar stations is identified, the tree model is created using the stations located within a cluster. To evaluate the estimates, lack of fit of predicted and observed concentrations are compared for both WRTDS and BRT.

It is hypothesized that the use of Boosted Regression Trees could improve the concentration estimates in stations with less than 200 samples. A machine learning approach appears to be an ideal solution for such situations. As the model is analyzing new stations, a routine or program could identify patterns, similarities, and differences with previous runs and decide which combination of stations produces the best estimates.

## II. WEIGHTED REGRESSIONS IN TIME, DISCHARGE, AND SEASON (WRTDS) METHOD

Weighted Regressions in Time, Discharge, and Season (WRTDS) is one of the most recent methods developed by the United States Geological Survey (USGS) with the purpose of analyzing long-term, water quality data sets. One of the strengths of the method is that parameters of the mathematical model adjust to changes that occur with time. In addition, it has the capability of downloading data and metadata automatically from the National Water Information System (NWIS). It also includes multiple routines that allow the user to conduct preprocessing of the original data sets and identify the presence of outliers and influential observations that may cause bias in the estimated concentrations.

Equation (1) shows the mathematical equation that serves as the foundation of the WRTDS method:

$$\ln(c) = \beta_0 + \beta_1 t + \beta_2 \ln(Q) + \beta_3 \sin(2\pi t) + \beta_4 \cos(2\pi t) + \varepsilon \quad (1)$$

Where  $c$  is the concentration, the  $\beta$  terms are the unknown regression coefficients,  $Q$  is the discharge,  $t$  is the time, and  $\varepsilon$  are the independent random errors.

In a regular regression, the fitted coefficients are constant for the entire data set. In WRTDS, each observed concentration is recalculated using a jack-knife cross validation procedure in which a subset is extracted based on windows that involve ranges in time, discharge, and season. The parametric survival regression conducted by the method has the advantage of accepting the presence of censored information.

Due to the generation of subsets, the number of samples and the period of data collected must be large in order to identify trends. Stations with few collected samples cause the method to calculate poor fitted coefficients.

## III. BOOSTED REGRESSION TREES (BRT)

Classification trees are an alternative to regression models to predict the concentration using the same terms included in equation (1). Classification trees have several advantages: (1) trees are very flexible and can accept broad types of responses including categorical, numerical, and survival data; (2) trees are invariant to monotonic transformations of the independent variables; (3) trees are easy to construct; and (4) trees are easy to interpret [17]. At the same time, trees have the disadvantage that they create poor predictors and in the case of large trees they are difficult to interpret [18].

When the response variable is numeric, the tree is considered a regression tree. On the other hand, when the response is categorical, the tree is called a classification tree. One advantage of classification trees is that they can be represented in a figure with branches and leaves representing the different homogeneous groups.

The tree is constructed by repeatedly breaking the data into exclusive subsets of homogeneous data to the extent possible. The splitting process continues until an overlarge tree is created, and then the tree is pruned to the desired size. In order to select the size of the tree that accurately predicts the prediction error, the method uses a procedure called cross validation. During cross validation, a portion of the observations is deleted and recalculated using the remaining observations. The recalculated values are compared with the original observations to calculate the prediction error.

Boosting appeared as a method to improve the poor prediction capabilities of classification trees [18-19]. Boosting is based on the idea that it is easier to find and average many weak classifiers than trying to find a single highly accurate prediction rule. The advantage of this method is that it is sequential. At each step the model is fitted iteratively to the training data by the current sequence of trees, and these classifications are used as weights to the next step. Incorrect classifications will have higher weights in the next step than cases that were hard to classify, increasing their chance to be correctly classified.

## IV. MODEL BASED CLUSTERING

Preliminary analysis of the BRT method indicated that the station is one of the parameters with the highest influence

during the generation of the tree. The initial step during the generation of the BRT model is the selection of a training set for the model. Nitrate + nitrite-N concentration in rivers and streams varied greatly due to land use practices, location, and fluctuations in discharge [20-21]. The concentration of nitrate + nitrite-N at the test station could be estimated by selecting nearby stations with similar discharge and concentration distribution. For this reason, it was proposed to create a large database with nitrate + nitrite-N concentrations and discharge values for multiple stations located throughout the U.S. and, using a clustering method, select those stations with concentration distribution similar to the distribution observed at the test site.

The R package mclust was chosen to select the nitrate + nitrite-N concentration and discharge values from those stations similar to the test station [22]. The package mclust implements a Gaussian hierarchical clustering algorithms and the expectation-maximization (EM) algorithm for a parameterized mixture of models with the possible addition of a Poisson noise term [23]. One of the advantages of mclust is that it automatically selects among 10 different combinations of the parameterizations of the covariance matrix finding the clusters with the best Bayesian Information Criterion (BIC).

V. RESEARCH METHODS

A Python program was combined with an R script to select information from desired stations and evaluate if there was an improvement in the estimation of nitrate + nitrite-N concentration using the BRT model. The program and script perform four steps during the process: (1) generation of a master dataset; (2) identification of stations with similar characteristics; (3) generation of BRT model; and (4) comparison between WRTDS and BRT models for stations along the Sipsey River (located near Tuscaloosa, Alabama).

A. Generation of Master Dataset

The first step in the process was to retrieve relevant information from two previous studies (Mississippi River [7,11] and the Chesapeake Bay [1] basins) and stations located near the Sipsey River. An interface tool was created to generate the training dataset. The user has the capability of either using the tool or creating a text file that includes the list of stations, the parameter to be analyzed, and the period of analysis. In the text file, each row corresponds to a station of the training dataset. The tool and interface are explained in section VI. Once all the stations have been entered into the system, the program will classify those stations with similar nitrate + nitrite-N concentration and discharge distributions.

The stations near the Sipsey River were selected from a recent analysis on the variability of nitrate + nitrite-N concentration and discharge completed for rivers of the Mobile Alabama River System (MARS) [8]. Table I shows a summary of the data for stations included in the comparison. Note that the station located in Sipsey River was not included in the training dataset (USGS station 02446500). The last column in the table indicates the assigned cluster that will be discussed in Section VII Results. The stations included in Table I were based on previous references, geographic proximity to the Sipsey River, similar drainage area size, and similar land uses

in the basin. Indeed, the MARS stations were selected because they have similar climate conditions to those expected at the Sipsey River.

TABLE I. DATA FOR SELECTED STATIONS

Basin	USGS Station Number	Nitrate + Nitrite Concentration (mg-N / L)		Logarithm of Discharge (m <sup>3</sup> /s)		Cluster
		$\bar{x}$	$\sigma$	$\bar{x}$	$\sigma$	
CHESAPEAKE	01491000	1.28	0.405	1.288	1.432	3
	01578310	1.09	0.375	7.353	1.077	3
	01594440	1.17	0.406	2.451	1.018	3
	01646580	1.12	0.491	5.54	1.272	3
	01668000	0.49	0.291	3.644	1.581	3
	01673000	0.268	0.106	3.013	1.402	1
	01674500	0.155	0.088	2.74	1.615	1
	02035000	0.23	0.144	5.102	1.214	1
MOBILE ALABAMA RIVER SYSTEM	02041650	0.171	0.139	3.133	1.587	1
	02411000	0.135	0.088	5.082	0.949	1
	02419890	0.172	0.067	4.163	1.016	1
	02424000	0.315	0.081	3.504	0.824	1
	02429500	0.142	0.086	5.553	0.678	1
	02444160	0.046	0.145	4.355	0.867	1
	02446500 <sup>a</sup>	0.105	0.071	2.256	1.23	1
	02454055	0.046	0.191	1.567	1.343	1
	02462000	5.03	2.458	1.334	0.701	4
	02464000	5.03	2.458	-0.197	2.146	4
	02466031	0.229	0.155	4.215	0.956	1
MISSISSIPPI	02469762	0.207	0.125	5.893	0.994	1
	02411000	1.11	0.4	9.034	0.795	3
	05420500	1.67	0.954	7.377	0.608	2
	05465500	5.39	2.508	5.47	0.928	4
	05586100	4.17	1.719	6.743	0.828	4
	05587455	3.06	1.271	8.007	0.646	2
	06934500	1.345	0.738	7.789	0.637	2
07022000	2.41	0.913	8.836	0.614	2	
07373420	1.38	0.508	9.698	0.537	2	

<sup>a</sup> USGS Station Sipsey River near Elrod, not included in the training dataset

B. Identification of Stations with Similar Characteristics

In general, the distribution of water discharge follows either power law or lognormal distribution [24]. Stations with similar median logarithm of discharge and median logarithm of nitrate + nitrite-N concentration could originate from areas of similar land use, catchment area, or times of concentration. Clustering

analysis was conducted on stations that shared similar median and standard deviation of the natural logarithm of the discharge and nitrate + nitrite-N concentration.

It was hypothesized that, as the number of stations in the cluster increased, the results of the BRT would improve by increasing the number of observations in the training set. The statistical program R was selected to calculate the median and standard deviation of the natural logarithm of the nitrate + nitrite-N concentration and discharge of all the stations included in the analysis.

One of the assumptions behind the idea of clustering stations of similar characteristics was that all the stations in the clusters would be affected by the same phenomena that were regional or national in scope. For example, it was hypothesized that if a specific year was wet, all the instruments included in the cluster recorded large discharge values that year. These two conditions could impact the coefficients related to time and discharge in equation 1. On the other hand, it was also considered that clustering stations located in regions with different climate patterns (i.e., northern versus southern U.S.) may affect the seasonal terms of the equation. For this reason, it was also considered preferable to select stations located within the same region.

### C. Generation of the BRT Model

In the previous step the function `mclust` identified four clusters. In this step, `mclust` identified which cluster was associated with the station located in the Sipsey River (in this case, Cluster 1). The stations within the same cluster of the Sipsey River were selected for the generation of the Boosted Regression Tree. The BRT model was created using the library `gbm` for the General Boosted Model [25].

The R function `gbm.step` was used to generate the General Boosted Model. This function determines the optimal tree size using the k-fold cross validation procedure [26]. The default option in `gbm.step` uses 10 folds and a bag fraction of 0.5, which indicates that 50 percent of the observations of the observed variables are selected to construct the model. As indicated previously, since the distribution of nitrate + nitrite-N concentration and discharge followed a lognormal distribution, it was assumed that the logarithm of these parameters should follow a normal distribution. The model requires the selection of a method to calculate the loss function. Because both discharge and nitrate + nitrite-N concentration are continuous variables, it was decided to use the Gaussian option to focus on minimizing the square error between the observed and predicted values.

The last two parameters in the function `gbm.step` are the tree complexity and learning rate. The learning rate refers to how quickly the estimated value is calculated based on the previous estimated value plus a portion of the value obtained by the fitted regression model. On the other hand, tree

complexity refers to the depth of the tree (also known as the interaction depth), which is a function of the number of terminal nodes in the tree. It has been recommended for the learning rate to be as small as possible and obtain the optimum number of iterations by cross validation [25]. It is important in BRT models to avoid a large number of iterations because that can cause overfitting [27]. Overfitting occurs when the model starts depicting the random error instead of the relation between the predictors and the response.

The authors conducted preliminary analyses using sites located in Alabama, varying the tree complexity between 2 and 20 and the learning rate between 0.0001 and 0.05. The results of these analyses indicated that, as the tree complexity increases, the number of trees decreases. The same pattern was observed between the learning rate and the number of trees. The lowest cross validation correlation standard error was observed when the tree complexity was 5 and the learning rate was 0.01.

### D. Comparison between WRTDS and BRT Model

In WRTDS the estimates are based on the observations from the same station. On the other hand, BRT estimates are based on observations from other stations. The goal is to observe which method generates better estimates of nitrate + nitrite-N concentration for each of the observed concentrations. A perfect fit creates a straight line between the observed and predicted values. The sum of square errors (SSE) was selected as a measure of fitness between the WRTDS and BRT models. The model with the lowest SSE would produce the best estimates.

## VI. SYSTEM DESCRIPTION

The interface tool was developed in Python. The WRTDS model, BRT model, clustering analysis, and comparison between models were completed using the statistical program R. Figure 1 shows a flow diagram describing how the Python tool and the R script interact during the estimation of the nitrate + nitrite-N estimates.

The graphical interface tool was developed using the Tkinter/ttk package that provides dynamic interaction between the program and the routines executed by R. The interface performs two main tasks: (1) processes information about the stations and parameters included in both models; and (2) executes an R script that creates and compares the WRTDS and BRT models. Figure 2 shows the interface tool that runs the simulation. The user enters the information of each station by completing the fields available on the main screen. Among the parameters needed by the model are the station number, parameter to be analyzed, discharge information, and period of analysis. The interface allows the user to either download automatically the information from the USGS website or access it from a text file that follows the format required by WRTDS.

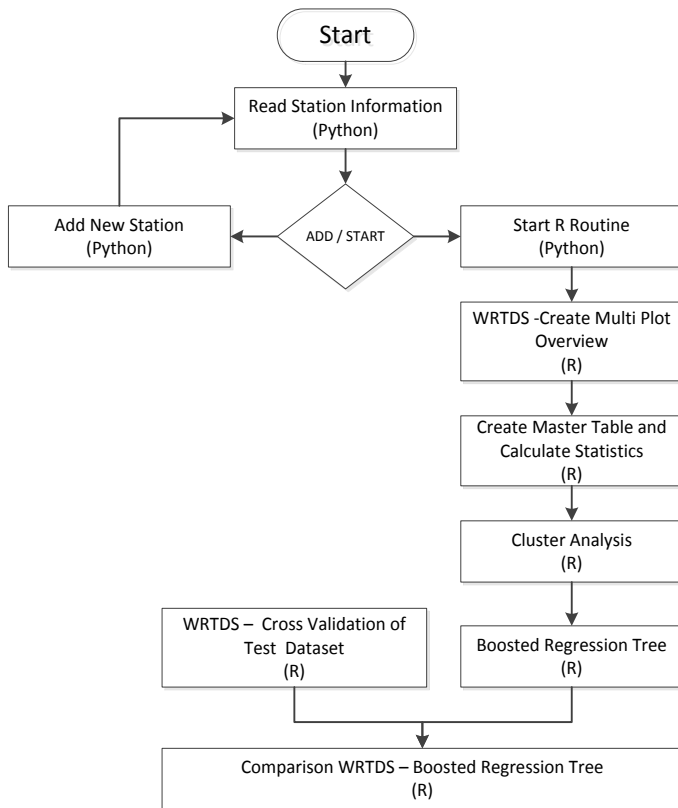

Fig. 1. Flow diagram of the steps involved in the development of the tool.

The “Add Station” button adds the information to a text file that will be read by the R script. The user adds as many stations as needed to run the model. The “Start” button initiates the R script program. In the background, R reads the information from the text file created by the interface tool and creates a data frame with all the records obtained from the selected stations. During this process, the tool automatically generates three figures for each station: concentration versus time, discharge versus time, and a multi-plot data overview (Figure 3). All the figures generated by the script are saved as images and pdf files in a separate folder.

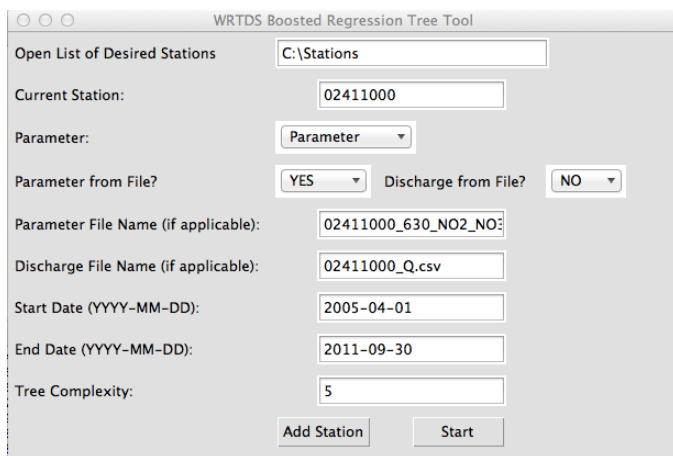

Fig. 2. Interface of the machine learning tool for comparison of WRTDS and BRT methods to estimate nitrate + nitrite-N concentration.

The script also generates three text files that could be used for further analyses: (1) a summary table with all the observations from all the stations; (2) a table that includes the median, standard deviation, and first and third quartiles of concentration and discharge for each station; and (3) a table that indicates the cluster assigned to each station during the cluster analysis.

## VII. RESULTS

In this article, we present the results for the stations included in Table I. Figure 3 shows an example of one of the multi-plot data overview figures generated by WRTDS (station 02411000, Coosa River, near Wetumpka, AL). The chart allows the identification of gaps, outliers, as well as influential points, and provides a general idea of the number of samples collected by month. The figure has four panels. In the upper left panel is a scatterplot of concentration versus discharge. This plot shows extreme events and potential correlations between discharge and concentration. Notice that both axes are in log scale matching the terms included in Equation (1). In the upper right box there is a scatterplot of the concentration versus time. This plot shows gaps and major changes in concentration with time. In the lower left corner is the distribution of samples by month. This box plot confirms that samples were collected throughout the year with a relative similar frequency. The lack of samples during specific times of the year could have an impact on seasonal components. Finally, in the lower right corner there are two box plots that compare the distribution of the discharge records for the whole period of analysis and when samples were collected.

In this case, the results demonstrated that there was a positive correlation between discharge and nitrate + nitrite-N concentration, no significant gaps or censored observations, a good distribution of samples collected during the year except for January, February, and May, and that the discharge distribution of the sampling dates was similar to the distribution of the whole period of analysis.

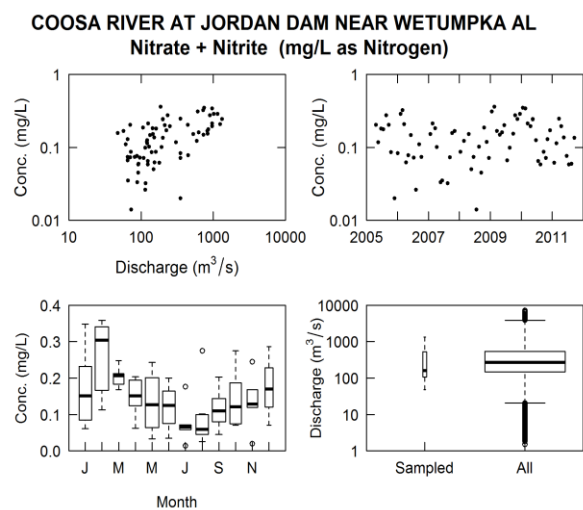

Fig. 3. Example of one of the multi-plot data overview figures generated by WRTDS.



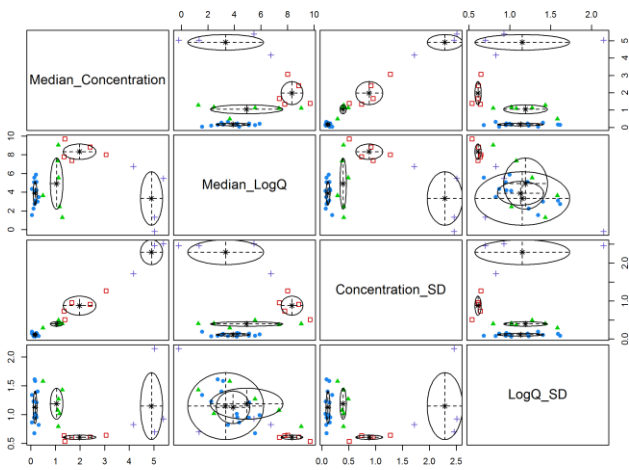

Fig. 4. Clustering example using the library mclust for USGS stations based on median and standard deviation of nitrate + nitrite-N concentration and logarithm of discharge. The four clusters are: Cluster 1 (blue circle), Cluster 2 (red square), Cluster 3 (green triangle), and Cluster 4 (purple plus symbol).

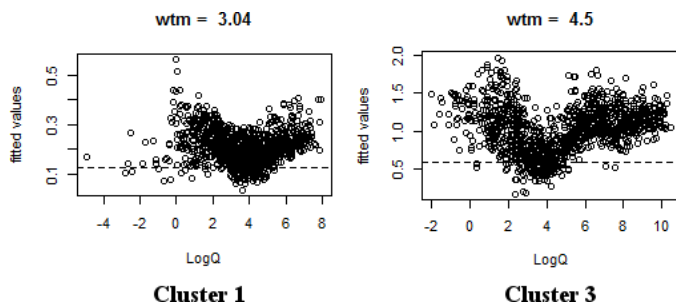

Fig. 5. Fitted values from the BRT models for Cluster 1 (low nitrate + nitrite-N concentration and intermediate discharges) and Cluster 3 (samples collected mainly in the northern part of the Chesapeake Basin).

Figure 4 and Table I show the results of the clustering analysis based on the concentration, discharge median and standard deviation of all the stations included in the analysis. The clusters are identified by colors: Cluster 1 (blue circle); Cluster 2 (red square); Cluster 3 (green triangle); and Cluster 4 (purple plus symbol). The analysis indicated that the best cluster model was the one that uses equal volume, equal shape, and variable orientation (EEV) with four clusters.

Figure 4 shows that there is a linear relation between the nitrite + nitrate-N concentration median and its standard deviation. This relation appeared in all the clusters. Another panel that shows a potential correlation involves the median nitrate + nitrite-N concentration with the median logarithm of the discharge. The results show that clusters are mainly generated by the range of concentration and geographical location. For example, all the stations with elevated median nitrate + nitrite-N concentration (greater than 4 mg/L as N) were clustered together (Cluster 4). Two of the stations were located in the Mobile Alabama River System (MARS) and two in the Mississippi Basin. These four basins appeared to be associated with urban and agricultural activities.

Cluster 2 appeared to be associated with elevated discharge and nitrate + nitrite-N concentrations. All of the stations in

Cluster 2 were located in the Mississippi Basin; Cluster 1 includes those sites with low nitrate + nitrite-N concentrations and intermediate flows. All of the Alabama sites and stations located in the Chesapeake Basin south of the Rappahannock River were included in this cluster. None of these sites have a median concentration greater than 0.5 mg/L as N. Finally, Cluster 3 shows similar discharge values to Cluster 1 but median nitrate + nitrite-N concentrations were between 0.5 and 1.5 mg/L as N. Based on these four clusters, four BRT models were created, one for each cluster.

Figure 4 also shows the clearly identified clusters in the plot of median nitrate + nitrite-N concentration and logarithm of discharge. It suggests that no large variation exists in the median concentration for a wide range of discharge variation except for Cluster 2. This could indicate that specific ranges of concentrations could be present for a wide range of discharges. In this panel, Clusters 1 and 3 show a similar range of discharge for small variations in nitrate + nitrite-N concentration.

Figure 5 shows the fitted values using the BRT models for these two clusters. There is a similar downward trend in concentration as the discharge increases until reaching a value of 50 m<sup>3</sup>/s. From that point the nitrate + nitrite-N concentration increases again with the increase in discharge until reaching a plateau for values larger than 400 m<sup>3</sup>/s. Figure 6 shows these patterns for the four clusters. Clusters 1 and 3 have a similar pattern. In these two clusters changes in discharge have a significant effect on concentrations with the initial decrease of concentration (dilution), increasing for values higher than 50 m<sup>3</sup>/s (re-suspension) and the plateau after 400 m<sup>3</sup>/s.

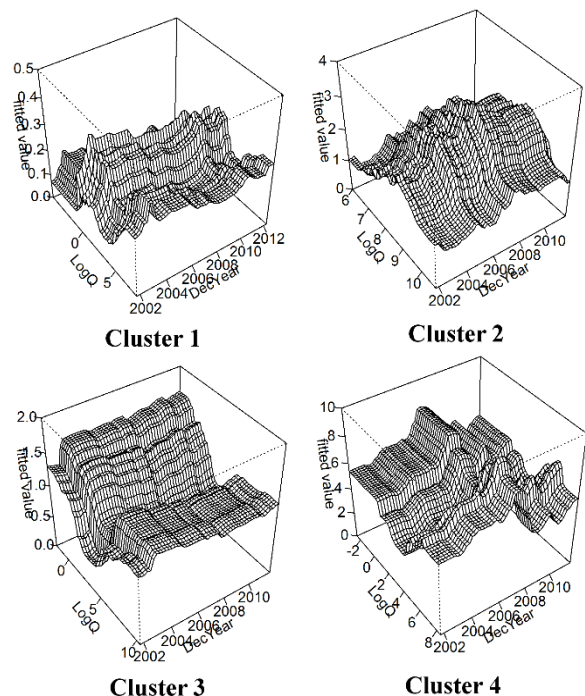

Fig. 6. Estimates of nitrate + nitrite-N concentration from the Boosted Regression Tree model at different conditions of time and discharge.

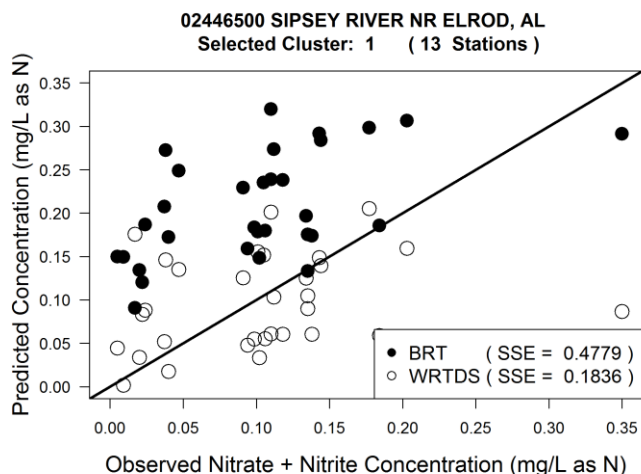

Fig. 7. Observed versus predicted nitrate + nitrite-N concentration values for the Sipsey River station at Elrod, AL. Predicted concentrations were obtained using WRTDS and BRT models.

Cluster 4 shows a similar pattern to the previous two clusters, but it is clear that there has been a strong decrease in nitrate + nitrite-N concentration with time in these four stations. This could be associated with changes in agricultural activities since 2008. In Cluster 2 the pattern is different than in the other clusters. It does not appear to have an initial dilution or change in concentration with time. Cluster 2 shows constant increase in nitrate + nitrite-N concentration until discharge values near 8,000 m<sup>3</sup>/s. A decrease in nitrate + nitrite-N concentration occurred in this cluster for larger discharges.

Finally, Figure 7 shows the observed versus predicted values at the Sipsey River station near Elrod, Alabama using both BRT and WRTDS models. It is expected that good estimates should all fall along a straight line with slope 1 that crosses the origin. This station was assigned to Cluster 1 with other 12 stations that have similar discharge and nitrate + nitrite-N concentration values.

The results of the WRTDS model are in white circles while the results of the BRT model are in black. Both models have similar results. Some of the predicted nitrate + nitrite-N concentrations using the BRT model fall directly on top of the straight line with slope 1, including the observation with the highest concentration. However, the sums of the square errors for both models indicated that the WRTDS model was better than the BRT. In fact, except for one estimate, all the estimates from the BRT model were higher than the observed nitrate + nitrite-N concentrations.

### VIII. DISCUSSION

In this paper, we presented an alternative method to WRTDS for the estimation of nitrate + nitrite-N concentrations in large rivers and streams. The results indicated that, even if the current estimates are not perfect or better than those obtained with WRTDS, the method has the potential of identifying stations with similar characteristics, correlations with several ranges of discharge, and trends with time. The method is promising because it can improve the estimates as data is collected and more stations are added to the system.

WRTDS is disadvantageous because it only uses data from the station that is being analyzed. For this reason, it requires a large number of samples collected during a period longer than 20 years. The combination of clustering and BRT allows the generation of large datasets with the goal of improving the accuracy of the estimates.

One of the advantages of combining clustering and BRT is the possibility of classifying streams and rivers based on the distribution of nitrate + nitrite-N concentration and discharge. Land uses and sources of nitrate + nitrite-N are in general different for each site included in the cluster. However, rain patterns, extreme events, and droughts can affect large areas of the country in a similar manner. The fact that many of the clusters were associated with geographical location suggest that changes in atmospheric deposition, human activity, and climate conditions will be observed in multiple stations at the same time.

Nitrate + nitrite-N concentration appeared to be highly correlated with water discharge in all the clusters. If stations located within the same cluster have the tendency to increase concentration as the discharge increases, it is expected that during a wet year the concentration estimates will be above average for all stations included in the cluster. It is important to continue research on methods or procedures that allow the extrapolation of trends and patterns observed in a group of stations to the station of interest.

### IX. CONCLUSIONS

The use of a machine learning tool combined with cluster analysis offers great potential for the advancement of hydrological models. Clusters and the use of trees help identify trends and potential correlations between nitrate + nitrite-N concentration and discharge. In the past, these correlations were assumed to be linear. New methods like WRTDS enhance the capability of modeling non-stationary processes in rivers and streams.

The possibility of analyzing multiple stations with similar nitrate + nitrite-N concentration and discharge distributions opens the potential for developing simple models that effectively simulate dilution and re-suspension conditions. Boosted Regression Tree (BRT) models have the potential of simulating these processes as well as identifying trends with time.

The use of BRT and clustering did not appear to be a good alternative for the estimation of nitrate + nitrite-N concentration in sites with small number of samples. The combination of samples from multiple stations increases the variability of estimates. The machine learning tool could be improved if the influence of the multiple stations is removed during the process.

Recently, there has been an interest in the importance of representing the non-stationarity of the physical processes in future hydrological models [28]. The possibility of identifying regional trends by clustering stations with similar patterns could help future models rapidly identify changes caused for variations due to climate change, water infrastructure, and changes in land use and land cover. This approach makes the

use of machine learning techniques and algorithms a powerful tool for the next generations of hydrological models.

Future work in this area includes the design of systems that are able to identify patterns in the data collected in real time or from forecasting models. Such systems can identify variables that reduce the magnitude of errors in the estimates and potential correlations that reduce variability.

#### ACKNOWLEDGMENT

This research was conducted as part of the Northern Gulf Coastal Hazards Collaboratory (NGCHC), a consortium that focuses on advancing the science and engineering of coastal hazards across the states of Alabama, Mississippi, and Louisiana. The research was partly supported by the NSF EPSCoR EPS-1010607 grant, 2013 USGS 104(G) Competitive Grants Program and the Alabama Water Resources Research Institute (Project 2013AL156B).

#### REFERENCES

- [1] R.M. Hirsch, D.L. Moyer, and S.A. Archfield, "Weighted regressions on time, discharge, and season (WRTDS), with an application to Chesapeake Bay River inputs," *JAWRA Journal of the American Water Resources Association*, vol 46, pp. 857–880, October 2010. doi: 10.1111/j.1752-1688.2010.00482.x
- [2] R Core Team (2013). R: A language and environment for statistical computing. R Foundation for Statistical Computing, Vienna, Austria. ISBN 3-900051-07-0, URL <http://www.R-project.org/>
- [3] R.M. Hirsch and L. De Cicco, dataRetrieval: Retrieval functions for USGS data. 2012. R package version 1.2.1.
- [4] R.M. Hirsch and L. De Cicco, Exploration and Graphics for River Trends (EGRET): An R-package for the analysis of Long term Changes in Water Quality and Streamflow, Including the Water Quality Method Weighted Regressions on Time, Discharge, and Season (WRTDS) Draft Manual. 2013. R package version 1.2.3.
- [5] R.M. Hirsch, 2012. Flux of nitrogen, phosphorus, and suspended sediment from the Susquehanna River Basin to the Chesapeake Bay during Tropical Storm Lee, September 2011, as an indicator of the effects of reservoir sedimentation on water quality: U.S. Geological Survey Scientific Investigations Report 2012–5185, 17 p. <http://pubs.usgs.gov/sir/2012/5185/>
- [6] Hirsch, R.M., D.L. Moyer, and S. Phillips, 2013. Determining Nutrient and Sediment Loads and Trends in the Chesapeake Bay Watershed by Using an Enhanced Statistical Technique. U.S. Geological Survey Science Summary (January 2013).
- [7] Sprague, L.A., R.M. Hirsch, and B.R. Aulenbach, 2011. Nitrate in the Mississippi River and Its Tributaries, 1980 to 2008: Are We Making Progress? *Environmental Science & Technology* 45(17):7209-7216. DOI:10.1021/es201221s
- [8] Maestre, A. Williamson, D. Ward, A. 2012. "Nutrient Fluxes in Rivers of the Mobile – Alabama River System using WRTDS". 2012 Alabama Water Resources Conference. Orange Beach, Alabama.
- [9] Moyer, D.L., Hirsch, R.M., and Hyer, K.E., 2012, Comparison of two regression-based approaches for determining nutrient and sediment fluxes and trends in the Chesapeake Bay watershed: U.S. Geological Survey Scientific Investigations Report 2012-5244, 118 p. <http://pubs.usgs.gov/sir/2012/5244>
- [10] Markus, M., Demissie, M., Short, M., Verma, S., and Cooke, R. 2013. A Sensitivity Analysis of Annual Nitrate Loads and the Corresponding Trends in the Lower Illinois River. *Journal of Hydrologic Engineering*. doi:10.1061/(ASCE)HE.1943-5584.0000831
- [11] Murphy, J.C., R.M. Hirsch, and L.A. Sprague, 2013. Nitrate in the Mississippi River and its tributaries, 1980 - 2010: An update. U.S. Geological Survey Scientific Investigations Report 2013–5169, 31p. <http://pubs.usgs.gov/sir/2013/5169>
- [12] Lewin, W.-C., Mehner, T., Ritterbusch, D., and Bramick, U. (2014). The Influence of Anthropogenic Shoreline Changes on the Littoral Abundance of Fish Species in German Lowland Lakes Varying in Depth as Determined by Boosted Regression Trees. *Hydrobiologia*, 724(1), 2014: 293-306. doi: 10.1007/s10750-013-1746-8
- [13] Chung, Y. S. (2013). Factor complexity of crash occurrence: An empirical demonstration using boosted regression trees. *Accident Analysis & Prevention*, 61, 107-118. doi: 10.1016/j.aap.2012.08.015
- [14] Soykan, C. U., Eguchi, T., Kohin, S., & Dewar, H. (2014). Prediction of fishing effort distributions using boosted regression trees. *Ecological Applications*, 24(1), 71-83. doi: 10.1890/12-0826.1
- [15] le Roux, P. C., Luoto, M. (2014), Earth surface processes drive the richness, composition and occurrence of plant species in an arctic–alpine environment. *Journal of Vegetation Science*, 25: 45–54. doi: 10.1111/jvs.12059
- [16] Bergstra, J., Pinto, N., & Cox, D. (2012). Machine learning for predictive auto-tuning with boosted regression trees. In: *Innovative Parallel Computing*, p. 1-9. IEEE. doi:10.1109/InPar.2012.6339587
- [17] De Ath, G. and Fabricius, K. (2000). Classification and Regression Trees: A Powerful yet Simple Technique for Ecological Data Analysis. *Ecology*, 81 (11), 2000: 3178–3192. doi: 10.1890/0012-9658(2000)081[3178:CARTAP]2.0.CO;2
- [18] De Ath, G. (2007). Boosted Trees for Ecological Modeling and Prediction. *Ecology*, 88 (1), 2007: 243–251. doi: /10.1890/0012-9658(2007)88[243:BTPEMA]2.0.CO;2
- [19] Elith, J., Leathwick, J.R., Hastie, T. (2008). A Working Guide to Boosted Regression Trees. *Journal of Animal Ecology*, 77 (4), 2008: 802-813. doi: 10.1111/j.1365-2656.2008.01390.x
- [20] Williams, G.P. (1989). Sediment Concentration versus Water Discharge During Single Hydrologic Events in Rivers. *Journal of Hydrology*, v. 111, p. 89 – 106
- [21] Johnes, P.J. (1996). Evaluation and Management of the Impact of Land Use on the Nitrogen and Phosphorous Load Delivered to Surface Waters: the Export Coefficient Modelling Approach. *Journal of Hydrology*, 183: 323 – 349
- [22] Fraley, C., Raftery, A., Murphy, T., Scrucca, L. (2012). MCLUST Version 4 for R: Normal Mixture Modeling for Model-Based Clustering, Classification, and Density Estimation. Technical Report No. 597. Department of Statistics, University of Washington. Seattle, USA.
- [23] Fraley, C. and Raftery, A. (1999). MCLUST: Software for Model-Based Cluster Analysis. *Journal of Classification*, 16: 297-306
- [24] Bowers, M. The Distributions of Seasonal Rivers Flows: Lognormal or Power-Law? Master of Science Thesis Purdue University, West Lafayette, Indiana. May 2012
- [25] Ridgeway G. with contributions from others (2013). gbm: Generalized Boosted Regression Models. R package version 2.1. <http://CRAN.R-project.org/package=gbm>
- [26] Hastie, T., Tibshirani, R., Friedman, J. (2009). *The Elements of Statistical Learning. Data Mining, Inference, and Prediction*. Springer Science+Business Media. New York, NY.
- [27] Jun, S. (2013). Boosted Regression Trees and Random Forests. Statistical Consulting Report for Michael Melnychuck. University of British Columbia.
- [28] McCuen, R., 2012. Hydrologic Modeling in 2050: Knowledge Requirements in a Multi-Nonstationary Environment. In: *Toward a Sustainable Water Future Visions for 2050*. American Society of Civil Engineers.

# Collaborative Pharmacy Student Learning Outline for Mobile Atmosphere

Dr. Mohamed F. AlAjmi,  
King Saud University, Riyadh,  
Saudi Arabia

Shakir Khan,  
Researcher at King Saud University,  
Riyadh Saudi Arabia Nationality Indian

**Abstract**— the idea of this research is for the concern of Collaborative learning based mobile factors by applying via pharmacy students of the college. We focus on three features, computer mutual learning, learning process module, and student learning mode. In this paper, student-focused instruct module, student edge section, teacher interface section, learner section, solution problem section, curriculum section, control section, and diagnose section are planned. This system permits students to be sustained with a real time approach, non-real time approach, mixture approach. The devices used contain smart phone, PDAs, mobile devices, transportable computers and tablet PDAs. This system is to become a more capable student learning environment so that student can get student's learning done more efficiently. The development of a collaborative learning combines the advantages of an adaptive learning environment with the advantages of mobile telecommunication and the suppleness of mobile devices.

**Keywords**—collaborative learning; mobile environment; real time approach; non-real time approach; mixture approach; lecture section; interface section; learner section; diagnose section

## I. INTRODUCTION

In current years, speedily increased mobile telecommunication and mobile devices utilize are extended and educational approaches are followed to open education via incorporated multimedia tele-learning system in cyberspace. The fast mobile technological development and the wider ease of access of high-quality telecommunications are advantage to bring about an important revolution in e-learning. The growth of learning lecture based on this kind of technology as graphics, image, voice, and video has turned into the media for collaborative learning. Collaborative learning plays a significant role of within the mobile learning, so mutual learning system must be designed to convince several key requirements. These important requirements are resultant from multimedia application progress platform base which is interfaced with CSCW (Computer-Supported Cooperative Work) technology, and education engineering [12].

M-learning is frequently thought of as a structure of e-learning, but it would be more properly defined as a part, or sub-level, of e-learning. M-learning is a new phase in the progress of e-learning that resides within its limitations [9]. M-learning is not just wireless or Internet standed e-learning but

should consist of the anytime/any place idea without stable connection to physical networks. The benefits of m-learning in comparison to e-learning include: flexibility, cost, size, ease of use and timely application. The devices utilized include smart phone, mobile phones, PDAs, portable computers and tablet PDAs [9]. The mechanisms of the mobile learning environment are mobile microprocessors, server module, movable telecommunication, and mobile sensors.

M-learning is more than besides the latest educational idea or method. Learning takes place not immediately in classrooms, but in the house, the place of work, the park, the library, museum, and in our daily connections with others [2]. A student is free to begin a class at several times within a specified time frame. This system is to become a more competent student learning environment so that student can obtain student's learning done more professionally. In collaborative learning, there are three approaches; in case of a real-time approach, this system designed to comprise audio/video/chatting control to perform m-learning. The most important aim of real-time approach is to give students with a user friendly environment to add-on classroom experience. In case of non real-time approach, the system is considered to contain a lecture editor to perform collaborative learning.

We focus on three features, computer-supported collaborative learning, learning process section, and student learning approach. This collaborative learning builds up a lecture section, student interface section, teacher interface section, learner section, solution problem section, curriculum section, control section, and diagnose section to extend a checking and contributing technology in an learning environment. In reality it seeks to improve it by giving the audio/video/chatting for non-real time and on-going communication. It wants to be appropriately guided or monitored in order to create the favored results.

## II. ARRANGEMENT OF MOBILE ATMOSPHERE

M-learning is a learning atmosphere supporting student learning using digital media in a geologically scattered environment. This system is explained with the following elements: content creator, service contributor, and wire-less network. Many devices such as PDA and smart phones are prepared with unusual hardware and software constraints. Hardware controls can be utilized to explain device hardware competence such as platform, CPU speed, screen size, memory size and resolution. Software control can be utilized to explain device software competence such as operating system, playable media type, browser and resolution [17].

### A. Mechanism of the mobile environment

Figure 1 shows the mechanism of the mobile learning environment. Mechanism of the mobile learning environment includes [3] [9]. Mobile microprocessors with memory will be rooted in every object and device. The information each C.P.U will be hold about the entity. When a student moves toward, the sensor senses their existence and will create transmitting information to the student's PDA and smart phone.

Server section will comprise the server, the learning strategies unit and a Database. The server controls the network resources. The instructive strategies unit permits for the application of strategies to strengthen and assist student understanding via communication and feedback. It analyses student reply to small quiz questions and proceeds more information or information in an unusual form when required. DB keeps all the data about the objects/devices, the users and the communications that happen.

Mobile telecommunication technology will be in the structure of Bluetooth and WiFi. The Bluetooth has weak power of signal, uses little control and wrap a relatively short distance. Its low power using up and capability to communicate with other devices is exceptionally beneficial when using handheld devices. The WiFi has a range and speed which surpasses that of Bluetooth. It is well-matched with any brand of Access Point and client hardware built to the WiFi standard.

Mobile sensors will be utilized to detect any modification in the environment. These will be located neighboring to the objects/devices and will be used to identify the presence of students. The sensors used will include closeness, to detect movement, and light, to notice changes in light strength. The section follows and locates each student within the m-space with the use of sensors. When a student moves toward an object, sensors wirelessly contact the intranet and mobile learning environment and broadcast information about the object.

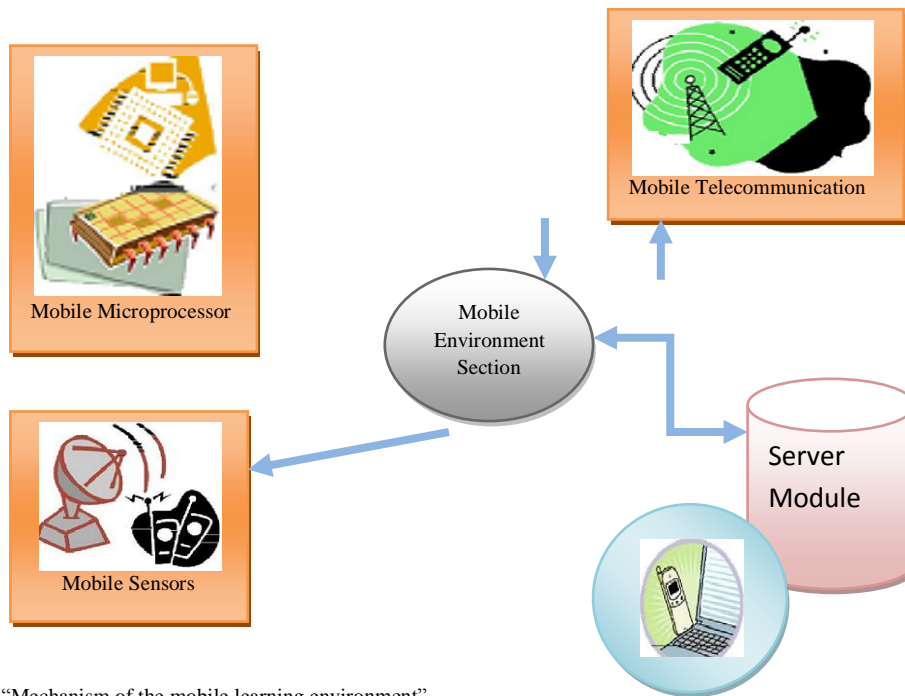

Fig. 1. "Mechanism of the mobile learning environment"

### B. Design

Mobile Learning is explained with the following fundamentals [3]: content creator, service provider, and wireless set of connections. Content creator presents data in an expressive and informative way.

The growth of learning content based on such technology like graphics, voice, image and video has turned out to be the resource for student learning service. Content creator provides a variety of function: generating and modifying a database structure, and adding, editing, deleting, and getting back records via querying and or working with various tables.

Content creator also includes producing links, producing tables, taking data. Planned arrangement of lecture note is found by teacher. The instructional objectives, process, and

methodologies are applied to the lecture note. A lecture note is extremely polished student-centered a lecture note methodology guarantees considerate of subject idea and features. The teacher set up a lecture note using a variety of tools to generate, edit and format an article and a lecture note is reserved in the server. Content creator also gives an editor form makes smooth the progress of anyone. It is probable to create lecture material by the document editor. In case of non-real time, content creator gives a subject learning content, feedback, and learning phase on demand from the student. Proper links has to be given as the reference materials. Links and indication to internal and external websites can also be given.

Service provider consists of various approaches: real time learning approach, non-real time learning approach, and



mixture learning approach. Service provider planned the execution of student learning system between student and educator in mobile environment. Service provider maintains the formation and deletion of the service entity for media utilize and sharing between remote students. Media Services edge the service by hardware restraint. During lecture time, the system maintains audio/video/chatting control for efficient communication of the students with the teacher. Wire-less network is in charge of data moving among mobile devices in scattered environment. Wireless network generate the network correlation, which overall form a collaboration work, destroys and carries out the functions controlling the QOS by cracking the network load. Wireless network reproduces multiple-point connection using stream and several applications share the same network connection.

### C. Aspects of mobile learning

In this paper, we will focus on mobile learning, mobile devices-supported student learning phase. The main features of mobile learning are shown as follows [3] [23].

**Reliability:** Students can never drop their study unless it is persistently deleted. In addition, all the learning processes are recorded endlessly.

**Convenience:** Students have access to their files,

documents, data, or videos from any place. This information is given based on their needs. Therefore, the learning concerned is self-directed adult learner.

**Immediateness:** Students can get any information immediately at any location. Therefore students can solve problems promptly. Otherwise, the student may record the questions and check for the answer later.

**Interactivity:** Students can interrelate with experts, teachers, or peers in the way of synchronous or asynchronous communication. Hence, the teachers are more accessible and the knowledge is more available at any time and at any place as well.

**Circumstances:** The learning could be implanted in our daily life. The problems came across as well as the knowledge necessary are all presented in the nature and authentic forms. It assists students and notices the features of difficult situations that create particular actions relevant.

**Flexibility:** Students can get the correct information at the exact place with the right way. Moreover, mobile learning can be CSCW environments that target on the social knowledge building and sharing. Figure 2 shows the main factors of mobile learning.

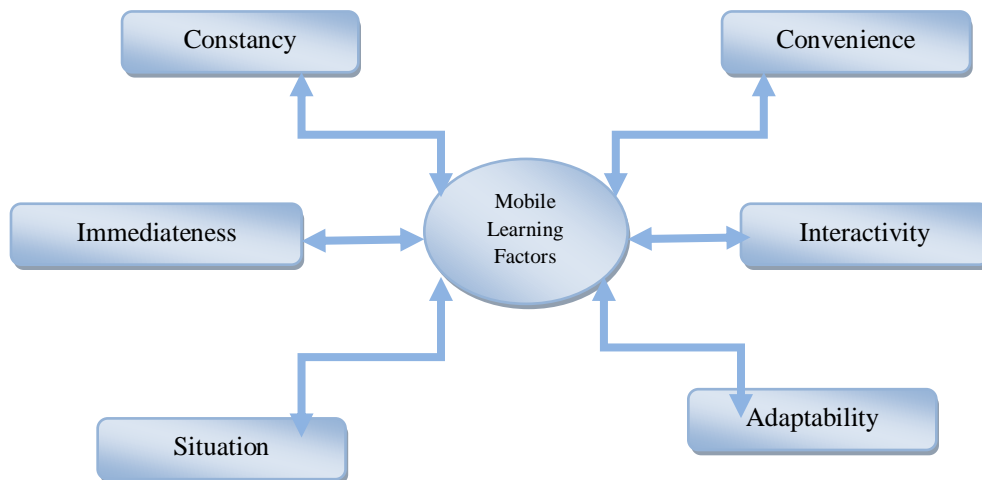

Fig. 2. “The main factors of mobile learning”

### III. COLLABORATIVE LEARNING

Collaborative learning is a variety of approaches in education that engage joint logical effort by students or students and teachers. Collaborative learning refers to methodologies and environments in which students connect in a general lecture in which each person depends on and is responsible to each other. Groups of students learn together in searching for understanding, significance or solutions of their study such as a product. The mode is closely linked to cooperative learning. Collaborative learning behavior can consist of collaborative writing, group projects, and other behavior. Collaborative learning has taken on various configurations [25]. The first is collaborative learning for the self-sufficient adult learner, youth going to collaboration, another configuration of self-sufficient organizing. Computer-

supported collaborative learning has come out as a novel educational model among researchers and practitioners in a number of fields, together with cognitive sciences, computer engineering, and sociology. Collaborative Learning also has an exact meaning in the environment of LMS (Learning Management Systems). In this environment, collaborative learning refers to a collection of tools which students can use to help, or be helped out by others. Such tools consist of chat, discussion threads, and application distribution among several others. Particularly appropriate to e-learning where developers can distribute and put together knowledge into courses in a collaborative atmosphere. Knowledge of a single subject can be pulled together from remote places via software systems.

#### A. Category of Collaborative Learning

Irregular learning collections are grouping of students

within a single class gathering. We can also form cluster of five students to crack a problem or create a question. Irregular groups systematize at any time in a class of any number of students to check on students' thought of the material, to give students a chance to apply what they are getting through this type of learning, or to give a transform of speed. Regular learning collections are teams well-known to finish a specific task, such as to carry out a class experiment, writing a report, performs a project.

These groups may finish their work in a particular class session or over several weeks. Normally, students work together until the task is completed, and their project is ranked. Group of students are long-term with regular membership whose foremost responsibility is to provide members with support, encouragement, and assist in finishing course necessities and assignments. Class groups also notify their members about lectures and coursework when student has missed a lecture. Bigger the class and the more difficult the subject matter, the more important class teams can be. The proposals below are considered to help you set up unbalanced learning clusters and class teams [25] [26].

### B. Components of Collaborative Learning

Primarily student interface section monitors the student's procedures, informing other agents when required and providing access to system resources. This component controls the access to the learner reproduction and passes to the learner information about the entire learning atmosphere.

Lecture component proposes the most appropriate problem/situation to the student, together with learning goals and the level of knowledge. Also the tutoring agent makes a decision on a specific strategy. Moreover, its didactical decisions are based on students' ideas. To achieve tutoring goals, it is able to initiate the lower-level element whenever a diagnosis is required and, once diagnosis phase is ended, it plans communications with other learners.

Teacher interface module is a mediator linked with the teacher's interface. This component controls the admission to the teacher's KB and brings to the student information about the complete learning atmosphere. This component intervene interface elements related to: contact with other teachers, update of novel activities to the students, sharing of such activities to students, and control of work done by students. Information KB is in charge for getting back and filtering information from particular sources that can vary from the learning resources and experiences available in the system to the whole Web. The communication component control the communication with other mediators, including influential message, sending out communication, and receiving and interpreting communication.

In Control component, learners select operators, authenticate actions, and authenticate the final result. Control elements are kept when attached to the reality that the learner makes declaration based on somewhat on the screen and utilizes this information to take and validate choices.

Diagnose component is in charge for replying other component queries. The strategy component considers entire solution paths and recommends advice only when the student finishes the problem. The clearest issue that comes up when tutoring mediator exists in a system is what to do when the tutoring mediator is not agreed. In the modules offered here, we might have circumstances where teacher approach module needs to present a communication at the same time.

Learner component is planned to meet the requirements of the learner. The learner representation is also used to observe if the information has already been educated to the student.

Learner DB consist of a management constituent which is in charge for organizing the learners, for instance passing on login names and passwords, and running two databases accessible in the system, that is the learner's history database and the database with the verified learning knowledge. A third database controls the learning profile of the learners, but this database is contacted by the learner elements of each learner.

KB includes a practical knowledge base and linked exercises to facilitate an efficient evaluation of the possible use of the system within a syllabus. Each tutor has its own specific tutor's information base and also succeeds to global knowledge from a common fact.

Solution Problem section becomes fulfilled when the group of problems it represents is there in the atmosphere. The arrangement of the different values these didactical variables could acquire, leads to more or less composite problems, permitting to focus on dissimilar aspects of the learning of indication and most important, allowing the expression of different ideas.

Syllabus module has course information which stands for the target skill and its component sub-skills, and depicts how they are linked. The teacher's common strategy is to present tutoring, ask questions, and assess answers. It generates and updates a student replica based on knowledge of the learner's ordinary language answers to evaluation questions. Figure 3 shows the component of collaborative learning [4] [8].

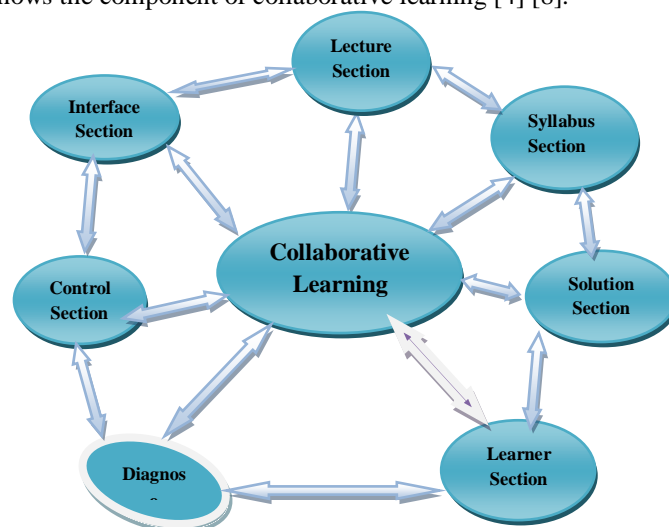

Fig. 3. "Shows the section of collaborative learning"



#### IV. APPROACH OF COLLABORATIVE LEARNING

##### A. Instantaneous technique

Real-Time Learning consists of m-learning server, teacher client, and student client. Two customer applications run under Symbian, Palm, iOS, Android, Windowphone7 on smart phone linked to the server. Client atmosphere consists of four components for student coincident learning services [3]: Teacher test information manager, Teacher test monitor, Student information searcher, and Student test manager.

Lecture manager: The teacher sets up a lecture via the various lecture note is reserved in the server. There is the lecture manager that five buttons of top are lecture framework, model lecture frame, lecture registration, lecture remove and lecture start button. The list box of hub is registered education subject list. This window means that the system is innate and simple for students to use.

Tool Manager: This module manages the use of audio and video resource to identify teacher/ students and also allocates who is the turn of speaking, makes a decision and manages suitable resource task according to application of resources. In tool manager, clarification of each module is as follows: Floor module controls the floor among participants, and it consists of video picture windows as many as the number of learners who contribute in the learning session. Video module is utilized for observing the video of remote applicants, and it shows the video image of the applicant who has the floor controls. Shared module is a window shared by all the applicants, and the delivery carried out by the teacher is informed to each applicant.

Searcher Manager: There is the learner information searcher that two buttons of top are check connection and check wait button. First, after input the server site, push the check connection button. The list box of center is a list of recorded education subject. Secondly, after choose the wishing subject list, push the check wait button.

Class manager: Students progress phase will be stored in a database to show student progress and adequate completion. This manager has the lecture note, which is circulated at the beginning. Lecture note is shared and every contributor draws.

##### B. Non- Instantaneous technique

Non- real time learning would add to change PDAs/ smart phone with their most important areas in stand-alone approach and non-interactive application. Non-real time learning is a revision of the idea of demand on lecture. Critical attributes of non- real time learning environments are time and place independence and the asynchronous nature of the PDA/smart phone-mediated communication[3][20].

These features mean that students and teachers do not require being online at the same time or put in order to be able to speak with one another. Thus, smart phone-based student education could be made available to students during particular time periods for students to finish at their free time. With simple network access, students could finish the learning from a lab, or remotely from their residence or place of work. Paper form was offered with a further form holding radio-button questions.

##### C. Combination Approach

In order to increase an efficient mixture learning that achieves the goals of providing education over the Web, it is compulsory to be aware of key instructional features that will add to the development. It also uses the values of cooperative learning to permit student to contribute in the cooperation of meaning resulting from their quiz of content and realistic testing. It also facilitates both teachers and students to interrelate in real-time or non-real-time in remote sites for interactive hypermedia-based education. After the non-real time education phase, students will be capable to put questions, via an audio channel, turn taking being proscribed by the teacher client. Student will also be trained to use toolbar to join to the smart phone and browse Web sites of relate. Using mixture education technology, student will study to improve references by generating live links to a linked file or Website [3].

#### V. TECHNOLOGY-BASED LEARNING'S POTENTIAL

Whereas even ten to fifteen years ago, the mass of TBL depended on transport video tapes or on costly satellite upload and downloads in special sites, most TBL content today is circulated via CD-ROMs or the Internet.

The Internet seizes meticulous guarantee among educational technologies since it without difficulty have room for multiple learning styles and scattered learning representation[27]. On the Internet, clients cannot only see all the content from text to movies to music; they can also interrelate with it, change it, generate innovative content, and distribute it back to a wider society. Additionally, the medium is well coordinated to the novel necessities of education and guidance in the knowledge-based financial system.

Just-in- Another important attribute of TBL is that it gives emphasis to 'knowledge solutions' and 'knowledge consequences,' and is appropriate and can be modified. As such it permits for a novel method to incorporate learning with employment. Rather than instructing workers on each possible process that they may require during their functioning lives, in an e-learning or TBL representation, employees have right of entry to the training component for a given development only if and when they call for it, possibly transported via a handheld computer[28]. Additionally, technology is previously in place that permits TBL release systems to expect future information and learning requirements by identifying patterns in knowledge styles and transporting training in large piece as required by the student.

##### A. Benefits and Challenges

TBL comes with considerable benefits. Most of all, it presents geographic achieve and a quality of being scalable of training and instructive hard work that face-to-face communication cannot realize. It also presents an extensive variety of learning styles and a chance to track development and calculate outcomes as a faultless part of knowledge. However, as with all skill applications, the utilization of technology in itself creates some innovative challenges. In TBL, the most important difficulty is the digital divide, which still cracks the country into digital haves and digital economically disadvantaged people. Additionally, transferring

education into a TBL environment produces additional challenges for instructors and teaching designers.

*a) Benefits*

There are abundant advantages to TBL in contrast to face-to-face learning. Five of the major benefits are the following:

- 1) *Ease of access, contribution anytime and anywhere release [29-30-31]*
- 2) *Teaching that is self-paced and coordinated to the student's requirements [32-33]*
- 3) *Complete scalability [34]*
- 4) *Timely broadcasting of latest information*
- 5) *Smooth and efficient learning release*

*b) Challenges*

The beginning of TBL is not without challenges. They consist of:

- 1) *The "digital divide," caused by low computer literacy rates and lack of right of entry to technology among a few student populations [35-36]*
- 2) *"Social loafing," which takes place when learners decrease their attempt in TBL programs, or are disturbed in their challenges to utilize TBL, because of the program's smaller center on personal communications*
- 3) *Higher slow destruction rates [37]*
- 4) *Long-suffering individuals with disabilities [38]*
- 5) *Technology inappropriateness*
- 6) *High progress costs*
- 7) *Lack of reliability [39]*

## VI. CONCLUSION

Collaborative learning is an educational approach to teaching and education that engages groups of student's knowledge together to resolve a problem, complete an assignment, or generate a product. It is during the talk that learning comes to mind [25]. There is countless advancement to collaborative learning. A set of hypothesis about the learning development underlies them all: Learning is a vigorous process whereby students digest the information and narrate this new knowledge to a framework of previous knowledge. Learning needs a test that opens the door for the student to keenly connect his/her peers, and to process and create information rather than just memorize and repeat it. Students gain when exposed to various viewpoints from people with varied backgrounds. Learning accompaniments in a social atmosphere where discussion between learners takes place.

Through this thinker gymnastics, the learner generates a framework and meaning to the discussion. In the collaborative learning environment, the students are tested both socially and emotionally as they pay attention to various perceptions, and are necessary to clear and defend their thoughts. In so doing, the students start to generate their own distinctive conceptual frameworks and not rely only on an expert's or a text's framework. Thus, in collaborative learning surroundings, students have the chance to communicate with peers, present and defend thoughts, exchange diverse thinking, question other conceptual frameworks, and are actively engaged.

Learning is a characteristic of living not of place. We have always been intelligent to learn in different settings other than the reserved classroom, and frequently in a more enjoyable, excellent, and useful way. But, mobile learning gives out to take you back of the need to persistently re-examine how learning takes place and to concentrate to the affordances of new technologies [24]. The idea of this research is for the concern of mobile learning atmosphere based real-time, non-real time and mixture approach. This paper projected the realization of learning between student and teacher of service contributor in u-space, which is not restricted to traditional learning system.

This system permits students to be maintained with a constancy, convenience, interactivity, situation, immediateness, adaptability. The system is to offer a trouble-free to utilize interface, so that the students are motivated to utilize it for their education. We also developed a set of necessities that supported by lecture component, student interface section, teacher interface component, learner module, solution problem component, curriculum component, control module, and diagnose component in order to complete an successful student collaborative learning. Also, the systems has several other rewards, which facilitate learning, PDA/smart phone service, real time, non-real time, mixture mode, high degree of data management and management of attendance[8].

We measured our m-learning system, usability and applicability, and concluded that it can be used for the multimedia PDA/smart phone in m-learning atmosphere. We are also in conflict for a better contest between theoretical frameworks and methods in m-learning research. While these are positively significant considerations, we believed that long-term access would be attained by the potential of contribution real time learning that are free from time and place control[11][12]. The improvement of a collaborative learning combines the advantages of an adaptive learning environment with the advantage of ubiquitous computing and the plasticity of mobile devices [3]. Students have the freedom to study within a learning atmosphere which presents flexibility to their person needs and learning approaches, as well as the flexibility of persistent and low profile computer systems. Collaborative learning practices can be integrated into a typical 50-minute class in a multiplicity of ways. A few require a systematic preparation, such as a long-term project, while others need less preparation, such as pretense a question in the lecture and putting students to talk about their thoughts with their neighbors. Despite of the particular approach taken or how much of the ubiquitous lecture-based course is substituted, the objective is the similar: to shift education from a teacher-centered to a student-centered model. This system is turned out to be a more competent student collaborative learning atmosphere so that student can acquire student's education done more professionally.

## ACKNOWLEDGMENT

The authors acknowledge the support from the Research Center, College of Pharmacy, King Saud University, Riyadh (KSA).

REFERENCES

- [1] A. Martens, "Support cognitive processes in intelligent tutoring systems", Proc. Of the International Conf. on Cognitive Modeling", Bamberg, Germany, 2003.
- [2] N. Gaby, & Z. Dietrich "Intelligent Methods to Evaluate Solutions of Interactive Calculation Exercises and Model-Based Experiments in Logistics Education", Proceedings of ED-MEDIA, Educational Multimedia and Hypermedia, pp. 521-526, 1996.
- [3] J.S. Sung, "U-Learning Model Design based on Ubiquitous Environment", IJAST, Vol 13, 2009.
- [4] J.S. Sung, "Application Protocol Design for Collaborative Learning", IJUNSSSET, 2(4), 2009.
- [5] C. Y. Chang & J. P. Sheu, "Design and Implementation of Ad Hoc Classroom and e-Schoolbag Systems for Ubiquitous Learning", Paper presented at the IEEE International Workshop on Wireless and Mobile Technologies in Education, August. 29-30, 2002.
- [6] G. Zhang, Q. Jin & M. Lin, "A Framework of Social Interaction Support for Ubiquitous Learning", Paper presented at the 19th International Conference of Advanced Information Networking and Applications, March 28-30, 2005.
- [7] H. Ogata, & Y. Yano, "Context-Aware Support for Computer-Supported Ubiquitous Learning", Paper presented at the 2nd IEEE International Workshop on Wireless and Mobile Technologies in Education, March 23-25, 2004.
- [8] J.S. Sung and D.H. Lim, "Adaptive Tutoring and Training System Based on Intelligent Agent", IJMUE, 2006, 1(3)
- [9] J. Vick & H. J. Jun, "Ubiquitous learning environment: An adaptive teaching system using ubiquitous technology"
- [10] K. Cat and H. Peter, "Designing agents for feedback using the documents produced in learning", International Journal on E-Learning, 4(1), 2005, pp. 21-38.
- [11] K. Edwards, M. Newman, J. Sedivy, T. Smith, D. Balfanz, D. K. Smetters, C. Wong & S. Izadi, "Using Speakeasy for Ad Hoc Peer-to-Peer Collaboration", Paper presented at ACM 2002 Conference on Computer Supported Cooperative Work (CSCW 2002), November 16-20, 2002.
- [12] N. Som, & O. Peter "Making the Most of Practical Experience in Teacher Education With Computer-Supported Collaborative Learning", AACE International Journal of Educational Telecommunications, 2(4), pp. 265-278, 1996.
- [13] M. Takahata, K. Shiraki, T. Sakane & Y. Takebayashi, "Sound Feedback for Powerful Karate Training", Paper presented at the International Conference on New Interfaces for Musical Expression, June 3-5, 2004.
- [14] N. Haruo, P. H. Kiyoharu, K. Yasufumi, & M. Shiho, "Designing Ubiquitous and Universal Learning Situations: Integrating Textbooks and Mobile Devices", Paper presented at the 19th Annual conference on Distance Teaching and Learning, 2003, August 13-15, 2003.
- [15] D. Georgio, D. Giuliano, & P. Domenico "Teacher-Learners Cooperation Procedures an innovative Computer-Based Course", Proceedings of ED-MEDIA, Educational Multimedia and Hypermedia, pp. 160-165, 1996.
- [16] R. Jeff, L. Neal, R. Charles, L. Candace, Sidner and G. Abigail, "Building a Bridge between Intelligent Tutoring and Collaborative Dialogue Systems", Tenth International Conference on AI in Education, 2001, pp. 592-594.
- [17] S. J. H. Yang, "Context Aware Ubiquitous Learning Environments for Peer-to-Peer Collaborative Learning, Educational Technology & Society, 9 (1), 188-201, 2006.
- [18] S. J. H. Yang, Lan., B. C. W. Wu, B. J. D. & A. C. N. Chang, "Context Aware Service Oriented Architecture for Web Based Learning", International Journal of Advance learning Technology, 2 (4), retrieved October 25, 2005 from [http://www.actapress.com/Content\\_Of\\_Journal.aspx?JournalID=63](http://www.actapress.com/Content_Of_Journal.aspx?JournalID=63)
- [19] V. Aleven, B.M. McLaren, I. Roll, and K. Koedinger, "Toward Tutoring Help Seeking: Applying Cognitive Modeling to Meta-Cognitive Skills", Proc. Of Intelligent Tutoring Systems (ITS), 2004.
- [20] W. Carine, B. Loris, P. Sylvie and B. Nicolas, "The Baghera project: A multi-agent architecture for human learning", available at <http://julita.usask.ca/Mad muc/Baghera.rtf>, 2001.
- [21] Z. Cheng, S. Shengguo, M. Kansen, T. Huang, & H. Aiguo, "A Personalized Ubiquitous Education Support Environment by Comparing Learning Instructional", Paper presented at the 19th International Conference on Advanced Information Networking and Applications, March, 28-30, 2005.
- [22] Z. Yiyi, G. Lei, and D. Nicolas, "AGILE: Architecture for Agent-Based Collaboration and Interactive Virtual Environments".
- [23] Chen et al., Curtis et al., 2002, In Young Scientific Research (2) no. 15700516 from Japan Society for the Promotion of Science.
- [24] Young Scientific Research (2) no. 15700516 from Japan Society for the Promotion of Science.
- [25] From Wikipedia, the free encyclopedia
- [26] From the hard copy book Tools for Teaching by Barbara Gross Davis; Jossey-Bass Publishers: San Francisco, 1993.
- [27] Brown, J. S. 2002. Growing up digital. *USDLA Journal*. Vol. 162
- [28] PEW Internet and American Life Project. 2005. *Latest Trends*. <http://www.pewinternet.org/trends.asp>
- [29] Australian Flexible Learning Framework. 2004a. E-Learning ambulance trainees top the class. *Organization Profile and Objective: Ambulance Service of New South Wales*. [http://pre2005.flexiblelearning.net.au/casestudies/casestudies/nsw\\_ambos.pdf](http://pre2005.flexiblelearning.net.au/casestudies/casestudies/nsw_ambos.pdf)
- [30] Australian Flexible Learning Framework. 2004b. South Australian police uphold the law with e-learning. *Organization Profile and Objective: South Australia Police*. [http://pre2005.flexiblelearning.net.au/casestudies/casestudies/sa\\_police.pdf](http://pre2005.flexiblelearning.net.au/casestudies/casestudies/sa_police.pdf)
- [31] Sloan Consortium. 2004. *Practice: Web-Based Doctor of Pharmacy Pathway: Expanding Access to Underserved Populations*. Sloan Consortium Website. Effective Practices. <http://www.sloan-c.org/>
- [32] Harris, P. 2005. Blended learning fuels sales at Toshiba. *Learning Circuits*. [http://www.learningcircuits.org/2005/nov2005/0511\\_Toshiba\\_Harris.htm](http://www.learningcircuits.org/2005/nov2005/0511_Toshiba_Harris.htm)
- [33] Summerfield, B. 2005. British Airways: The wings of learning. *Chief Learning Officer Magazine: MediaTec Publishing*. <http://www.clomedia.com>
- [34] Hollis, E. 2004. U.S. Navy: Smooth sailing for education. *Chief Learning Officer Magazine: Media Tech Publishing*. [http://www.clomedia.com/content/templates/clo\\_casestudies.asp?articleid=376&zoneid=9](http://www.clomedia.com/content/templates/clo_casestudies.asp?articleid=376&zoneid=9)
- [35] National Telecommunications and Information Administration U.S. Department of Commerce: Economics and Statistics Administration. 2002. *A Nation Online: How Americans are Expanding their Use of the Internet*. <http://www.ntia.doc.gov/ntiahome/dn/anationonline2.pdf>
- [36] Bell, P., P. Reddy, and L. Rainie. 2004. Rural areas and the Internet. *Pew Internet & American Life Project*. [http://www.pewinternet.org/PPF/r/112/report\\_display.asp](http://www.pewinternet.org/PPF/r/112/report_display.asp)
- [37] University of Central Florida. 2006. *Distributed Learning Impact Evaluation*. <http://pegasus.cc.ucf.edu/~rite/impactevaluation.htm>
- [38] The Rehabilitation Act Amendments of 1998 mandates. <http://www.usdoj.gov/crt/508/508law.html>
- [39] Adams, J. and M. DeFleur. 2005. The acceptability of a doctoral degree earned online as a credential for obtaining a faculty position. *The American Journal of Distance Education*. <http://www.leaonline.com/doi/abs/10.1207/s15389286ajde1902>

# Arabic Natural Language Processing Laboratory serving Islamic Sciences

Moath M. Najeeb

Computer Science Department at Al-  
Gunfudah Umm Al-Qura University  
Al-Qunfudah, Saudi Arabia

Abdelkarim A. Abdelkader

Computer Science Department at Al-  
Gunfudah Umm Al-Qura University  
Al-Qunfudah, Saudi Arabia

Musab B. Al-Zghoul

Information System Department at  
Al-Gunfudah Umm Al-Qura  
University Al-Qunfudah,  
Saudi Arabia

**Abstract**— Arabic Natural Language Processing (ANLP) has a great attention as a new research topic in the last few years. In this paper an ANLP laboratory has been created to serve the Islamic Sciences, especially the science of Hadith. The main tasks of this laboratory are creating and using the necessary linguistic resources (Corpora, Lexicon, etc) in developing or adapting the basic tools (Parser, POS-tagger, etc), developing Arabic Natural Language Processing system's evaluation framework and defining research areas and services for universities. The laboratory can also adapt the important theories, resources, tools and applications of other natural language processing such as English and French.

**Keywords**—Natural Language Processing; Arabic Language; Islamic Sciences; Framework; Laboratory

## I. INTRODUCTION

Natural Language Processing (NLP) is an artificial intelligence branch which has the ultimate goal to invent theories, discover techniques and build software that can understand, analyze and generate the nature human languages in order to interface with computers in both written and spoken contexts using natural human languages, so NLP gives computers the ability to understand the way humans learn and use language is the most challenge inherent in natural language processing [1]. The NLP techniques parse linguistic input (word, sentence, text, dialogue) according to the rules (derivational rules, inflectional rules, grammatical rules, etc.) and resources (like lexicon, corpus, dictionary) of the target language. At the present time, this is at the advanced stages of development especially for the English language. We expect that the current century will focus on NLP.

After several decades of heavy research activity on English NLP and other languages, Arabic Natural Language Processing (ANLP) have become a popular area of research, and some ANLP laboratory have been created [2]. There are some efforts to create ANLP tools [3], but these efforts always face two main challenges: the agglutination in Arabic language and dispensability of vowel diacritics [4].

This enthuases us to work on our language, so we establish a laboratory for Arabic Natural Language Processing to serve Islamic Sciences in Computer College at Al-Gunfudah at Umm Al-Qura University in 2014, this laboratory aims to contribute and involve in research on Islamic Ssciences and Arabic Natural Language Processing and corpus linguistics. Our work focuses on tools and corpus resources for analysis and

modeling of Arabic language, especially Classical Arabic (which is the language of the Quran, and it is used primarily for reading and reciting Islamic holy text).

The remainder of this paper is organized as follows: The second section gives the main features of the Arabic language. The third section describes the Arabic Natural Language Processing Framework. The fourth section defines the proposed plan for NLP laboratory, and finally the conclusion and the future work explained in section five.

## II. MAIN CHARACTERISTICS OF THE ARABIC LANGUAGE

As its name implies, the Arabic language is the language spoken at the origin by the Arabs. It is a Semitic language (like Hebrew, Armenian and Acadian). Strategically, it is the native language of more than 330 million speakers [2] living in an important region with huge oil reserves crucial to the world economy and home as well to the sacred sites of the world three monotheistic religions. It is also the language in which 1.4 billion [5] Muslims perform their prayers five times daily.

There are two main types of Arabic language: Classical Arabic and Modern Standard Arabic:

### A. Classical Arabic

The language of the Qur'an and classical literature. It differs from Modern Standard Arabic mainly in style and vocabulary, some of which is archaic. All Muslims are expected to recite the Qur'an in the original language, however many rely on translations in order to understand the text.

### B. Modern Standard Arabic (اللغة العربية الفصحى / *al-luġatu l-'arabiyyatu l-fuṣḥā*)

Universal language of the Arabic-speaking world which is understood by all Arabic speakers. It is the language of the vast majority of written material and of formal TV shows, lectures, etc.

The Arabic alphabet counts twenty-eight letters (or 29 if we add the "hamza" that can be considered a letter). There is no difference between the handwritten letters and the printed letters; the notions of capital letters and lower case letters don't exist. On the other hand, the letters have, most of the time, a different shape depending on their position in words: isolated, in the beginning, in the middle or in the end [6].

Arabic belongs to the Semitic family of languages. One of the characteristic features of Semitic languages is their system

of roots and patterns. Most (but not all) Arabic words have trilateral roots—in other words, there are three consonant letters in these words that connect them to a “root” meaning and to other words that share the same root. In Arabic, we can manipulate roots by varying the internal (short) vowel-ling between the root letters, by adding suffixes and prefixes, or placing other consonants and long vowels between the root letters [7].

The root word s-l-m is a common example. From the basic verb “salima”, (to be safe), we can derive other verbs such as *sallama*, “to hand over or deliver;” *aslama*, “to submit;” and *istaslama*, “to surrender.” The nouns *salaam*, “peace;” *salaama*, “health or safety;” and *muslim*, “a Muslim,” derive from the same roots.

Arabic tends to prefer the word order VSO (verb before subject) rather than SVO (subject before verb) [8]. However, the word order is fairly flexible, since words are tagged by case endings. Subject pronouns are normally omitted except for emphasis or when using a participle as a verb (participles are not marked for person). Auxiliary verbs precede main verbs, and prepositions precede their objects.

Adjectives follow the noun they are modifying, and agree with the noun in case, gender, number, and state: For example, “*bintun jamīlatun*” “a beautiful girl” but “*al-bintu l-jamīlatu*” “the beautiful girl”, “*al-bintu jamīlatun*” “the girl is beautiful”. Elative adjectives, however, precede their modifying noun, do not agree with it, and require that the noun be in the genitive case.

Arabic has three grammatical cases roughly corresponding to: nominative, genitive and accusative, and three numbers: singular, dual and plural. Normally, singular nouns take the ending -u(n) in the nominative, -i(n) in the genitive and -a(n) in the accusative. Some exceptional nouns, known as *dip-totes*, never take the final n, and have the suffix -a in the genitive except when the *dip-totic* noun is in the definite state (preceded by *al-* or is in the construct state).

However, case is not shown in standard orthography, with the exception of indefinite accusative nouns ending in any letter but *ta marbuta* or *hamza*, where the -a(n) “sits” upon an *alif* added to the end of the word (the *alif* still shows up in unvowelled texts). When speaking or reading aloud, articulating the case ending is optional. Technically, every noun has such an ending, although at the end of a sentence, no inflection is pronounced, even in formal speech, because of the rules of ‘pause’[9].

### III. ARABIC NATURAL LANGUAGE PROCESSING FRAMEWORK

There are some projects in Arabic Nature Language Processing (ANLP) that can lead to extract the main specification and requirements to build a general framework for ANLP, one of the most important issues is to draw a “road map” of this framework; which means to determine the goals of the framework, the tasks that must be achieved, and to determine the resources and the tools that could be used to serve the ANLP projects.

The second issue that must be considered is the expertise and the group works involved in the ANLP framework, these groups must be consistent with the main goals of the ANLP framework. The groups must contain experts in different areas such as: Arabic Linguistics, Software Engineering, Programming and Algorithms, Scientific Research and Artificial Intelligence, also the groups must contain administrative staff from the national agencies concerned with the Arabic language research.

The third issue that must be considered into ANLP framework is the “Projects developments”; which determine and explain the resources, tools and applications that must be created or improved, these projects include: Arabic Summarization, Automatic Arabic Answering System, Automatic Arabic Translation, Arabic Transliteration, Arabic Spell Checker, etc.

Arabic language has many specific features that distinct it from other languages, so any ANLP framework must consider these features or it will be unfortunate framework. The framework must take into account the Arab world people’s aspirations such as: the knowledge translation from other languages, reforming Arabic grammars or create new ones to facilitate the building of the ANLP tools, create variant applications for summarization, Information Retrieval, etc.

There are many obstacles in creating ANLP framework; one of them is the lake of the ANLP resources and tools due to the difficulties in transforming and adapting resources and tools from other languages.

Another obstacle is the regional dialects; these dialects are used by Arab people on daily basis beside the MSA and Classical Arabic, so it is a challenge to build one framework for all these types.

There are some obstacles related to Arabic scripts; as example, Arabic language does not have a specific characters to show the short vowels, sometimes, short vowels can be presented by diacritics in Classical Arabic, but MSA and dialects rarely use the diacritics, also Arabic letter has many shapes depending on its position in the word, so the tokenization process represents a challenge in Arabic language because one word may contain many tokens.

Another obstacle facing ANLP tools is the syntax form of the Arabic sentence; in Classical Arabic and MSA the VSO (Verb, Subject, Object) form is used, whereas in dialects the SVO (Subject, Verb, Object) and OVS (Object, Verb, Subject) forms can also be used beside VSO form, this will change the sentences structure and sometimes the meaning of the sentence. These issues must be considered in the ANLP framework creation.

### IV. PROPOSED LABORATORY FOR ISLAMIC SCIENCES

As we mentioned earlier, our work focuses on tools and corpus resources for analysis and modeling of Arabic language, especially classical Arabic (which is the language of the Quran, and is used primarily for reading and reciting Islamic holy text).

Services to be provided by the members of the laboratory can be organized around the following axes:

- *Development of content processing tools* such as bibliographic study (related works on ANLP, and Islamic sciences)
- *linguistic studies*: investigate the characteristics of Arabic language especially classical Arabic, the classical Arabic morphology, the grammar, some Islamic studies like “mustalah Alhadith”
- *Research and development*: which concentrate on the implementation and development of the theories and algorithms those were required in the laboratory , the defining of research areas and issues and presenting them to research centers, the identification, definition and development of ANLP tools and resources such as: corpus, lexical semantic network, Treebank, parallel corpus, parser, tagger, syntactic analyzer, the application of this tools on Islamic sciences especially the science of Hadith.
- *Integration and evaluation*: Integrating existing and new components for evaluation and providing services and Evaluating systems and tools developed in the laboratory or outside it.
- *Standardization*: Identification and development of standards for the laboratory’s various products and activities such as test dataset, interfaces, evaluation procedures and the application of e-learning and m-learning standards like SCORM and LOM.

The laboratory will be formed in a three-layer model, the first layer represent ANLP (Linguistic) resources, ANLP (Linguistic) tools and algorithms and theories in the second layer and ANLP applications in the third layer. The scheme of this model is shown in figure 1.

Until now, many linguistic studies and discussions with linguistics experts have been achieved, the objective of these studies is to understand the Arabic language morphology and grammar and linguistic phenomena like the coordination, the anaphor, the ellipse, etc.

Since Arabic morphological analysis techniques have become a popular area of research, several systems are known in the Morphological Analysis domain [7], for example, the Khoja stemmer [10], the Buckwalter Morphological Analyzer [11], and AlKhalil Morpho System [12]. AlKhalil (AlKhalil Morpho Sys) could be considered as the best Arabic morphological system, it won the first position, among 13 Arabic morphological systems around the world, at a competition held by the Arab League Educational, Cultural and Scientific Organization (ALECSO) (المنظمة العربية للتربية والثقافة و العلوم) and King Abdul Aziz City for Science and Technology (KACST). So, we had put a special effort on understanding and testing it and used its open source database as part of our linguistics resources. For a given word, AlKhalil identifies all possible solutions with their morphosyntactic features: vowelizations proclitics and enclitics, nature of the word Voweled patterns, stems, Roots Syntactic [12].

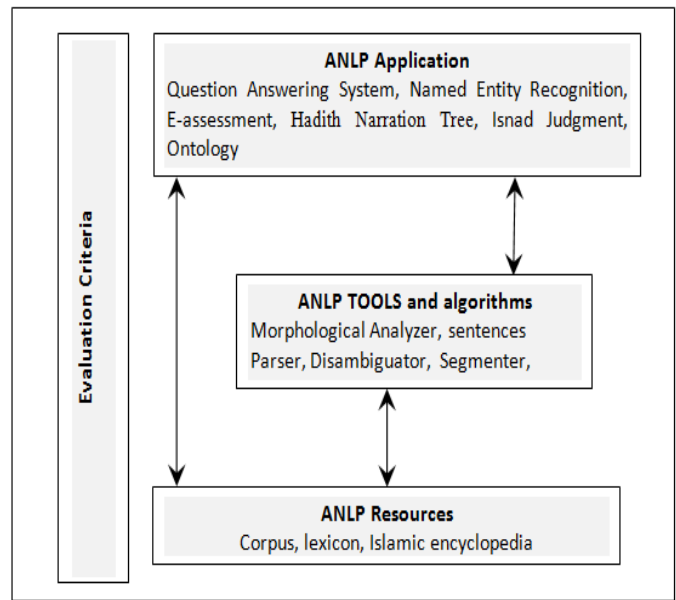

Fig. 1. ANLP Model

As we mentioned in the introduction, we will develop a new tools and algorithms, and also using the existing ones such as AlKhalil to serve the Islamic Sciences, especially the science of Hadith (the second fundamental source of Islamic legislation after the holy Quran). Each Hadith consists of two parts: the narration, known as matn and the chain of narrators through whom the narration has transmitted, traditionally known as Isnad.

Since the early centuries, Muslims are interested of Isnad science because it helps differentiate between the sahih (accepted) and da'ief (rejected) Hadith. The scholar of hadith judges it based on the narration chain and the individuals involved in the chain.

Through this laboratory, we want to develop this science using the new technologies. We will build a domain-dependent ontology that helps to automatically generate a suggested judgment of Hadith Isnad and share the common understanding in this science. For this purpose we will use the e-Narrator application. This application parses a plain Hadith text and automatically generates the full narration tree [13].

## V. CONCLUSION AND FUTURE WORK

Arabic Natural Language Processing framework was discussed and a laboratory for Islamic sciences has been initiated in Umm Al-Qura university, the laboratory aims to create new theories, resources and tools for Arabic Natural Language Processing and adapt the existing one to serve the Islamic sciences especially the science of Hadith.

In the future work, ontology for all concepts of Hadith will be created. So, we will begin by studying Hadith sciences to extract the components of this ontology (objects, properties, relations and rules). Next, we will develop an approach based on natural language processing techniques to the automatic generation of ontology instances from a collection of hadith documents.



#### ACKNOWLEDGMENT

The authors would like to greatly acknowledge the help and support of Dr. Yassine A. Alzubedi the dean of the Computer College at Al-Gunfoudah at Umm Al-Qura University, Makka, Saudi Arabia..

#### REFERENCES

- [1] A. Abdelkader, D. Souilem Boumiza and R. Braham, "A categorization algorithm for the Arabic language," International Conference on Communication, Computer and Power (ICCCP'09), Muscat, February 2009.
- [2] NLP4Arabic. <https://sites.google.com/site/nlp4arabic/> 2014.
- [3] A. Farghaly, K. Shaalan, "Arabic natural language processing: challenges and solutions," ACM Trans. Asian Lang. Inform. Process. 8, 4, Article 14, 22 pages, December 2009.
- [4] Khaled Shaalan, "Rule-based approach in Arabic natural language processing," International Journal on Information and Communication Technologies, Vol. 3, No. 3, June 2010.
- [5] CIA. 2008. CIA Word Fact Book. Central Intelligence Agency, Washington, D.C.
- [6] Y.A. Alotaibi, A.H. Meftah, "Comparative evaluation of two Arabic speech corpora," Natural Language Processing and Knowledge Engineering International Conference, pp. 1-5, 2010.
- [7] Al-Sughaiyer, I. Al-Kharashi, "Arabic morphological analysis techniques: A comprehensive survey," Journal of The American Society for Information Science and Technology (JASIST), John Wiley & Sons, Inc., NJ, USA, 55, 3, 189-213, 2004.
- [8] A. Abdelkader, D. Souilem Boumiza and R. Braham, "An online Arabic learning environment based on IMS-QTI," 10-th IEEE International Conference on Advanced Learning Technologies, Sousse Tunisia, July 2010.
- [9] M. Altabbaa, A. Al-Zaraee and M. Shukairy "An Arabic Morphological Analyzer and Part-Of-Speech Tagger," A Thesis Presented to the Faculty of Informatics Engineering, Arab International University, Damascus, Syria.
- [10] Al-Sughaiyer, Imad A. and Ibrahim A. Al-Kharashi. "Arabic Morphological Analysis Techniques: A Comprehensive Survey". Journal of the American Society for Information Science and Technology 55(3):189-213. 2004.
- [11] LDC, Linguistic Data Consortium. Buckwalter Morphological Analyzer Version 1.0, LDC2002L49, 2002. <http://www.ldc.upenn.edu/Catalog/>.
- [12] Alkhalil Morpho Sys: A Morphosyntactic analysis system for Arabic texts (2010, April 16). Retrieved February, 2014, from ALECSO: [http://www.alecso.org.tn/index.php?option=com\\_content&task=view&id=1302&Itemid=998&lang=ar](http://www.alecso.org.tn/index.php?option=com_content&task=view&id=1302&Itemid=998&lang=ar).
- [13] Aqil M. Azmi and Nawaf bin Badia, "e-NARRATOR – AN APPLICATION FOR CREATING AN ONTOLOGY OF HADITHS NARRATION TREE SEMANTICALLY AND GRAPHICALLY Aqil M. Azmi and Nawaf bin Badia, Department of Computer Science, King Saud University, Riyadh, Saudi Arabia, 2011.

# Improved Generalization in Recurrent Neural Networks Using the Tangent Plane Algorithm

P May  
K College, Brook Street,  
Tonbridge, Kent, UK

E Zhou  
Applied Engineering and Science  
Academic Group, University of  
Bolton, UK

C. W. Lee  
Applied Engineering and Science  
Academic Group University of  
Bolton, UK

**Abstract**—The tangent plane algorithm for real time recurrent learning (TPA-RTRL) is an effective online training method for fully recurrent neural networks. TPA-RTRL uses the method of approaching tangent planes to accelerate the learning processes. Compared to the original gradient descent real time recurrent learning algorithm (GD-RTRL) it is very fast and avoids problems like local minima of the search space. However, the TPA-RTRL algorithm actively encourages the formation of large weight values that can be harmful to generalization. This paper presents a new TPA-RTRL variant that encourages small weight values to decay to zero by using a weight elimination procedure built into the geometry of the algorithm. Experimental results show that the new algorithm gives good generalization over a range of network sizes whilst retaining the fast convergence speed of the TPA-RTRL algorithm.

**Keywords**—real time recurrent learning; tangent plane; generalization; weight elimination; temporal pattern recognition; non-linear process control

## I. INTRODUCTION

It is usually the case that smaller networks generalize better than larger ones. To limit the size of the network, it can either use additive [1 - 3], subtractive [4 - 6] or weight decay techniques [7 - 9]. A common feature is that they try to balance the representational capacity of the network against the information criterion in the training data. Weight decay techniques are considered here.

The principal idea of weight decay is to have the network remove the superfluous weights by itself. This can be achieved by giving each weight connection a tendency to decay to zero so that connections disappear unless they are reinforced. The simplest method is to subtract a small proportion of a weight after it has been updated. This is equivalent to adding a penalty term to the original error function and performing gradient descent on the resulting total error. While this method clearly penalizes more connection weights than necessary, it overly discourages large weights. May et al [7] have shown that using a weight elimination procedure which forces small weight values to decay faster than the large ones is an effective method for removing superfluous weights from a neural network whilst causing minimal disturbance to the learning process. Simulation results show that it outperforms weight decay in back propagation learning. Williams [8] have shown that the method of maximum entropy indicates a Laplace prior and proposes a penalty term based on the L1 norm of weights. A further refinement of this approach

involves using a sparseness measure based on the L1 and L2 norm of weights [9]. Experiments with Hoyer's method indicate that it performs well in comparison with weight decay and weight elimination.

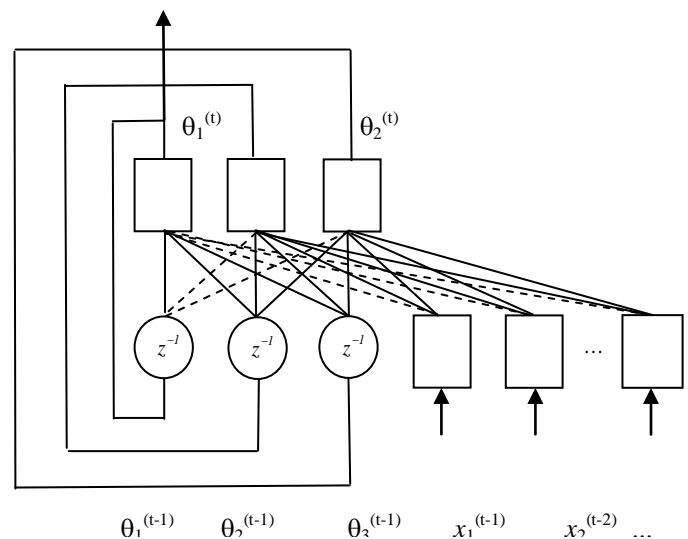

Fig. 1. An example of a fully recurrent neural network with one output unit, two hidden units, and two input units. In this figure the dotted lines represent connections that have been removed from the network

Pruning techniques reduce the number of free parameters in a neural network by removing redundant units and connections. If applied properly this approach often improves generalization. Giles et al [4] have made a comparison of pruning and weight decay in a second order recurrent neural network. Simulations were carried out on strings generated by two regular grammars, a randomly generated 10 state grammar and an 8 state triple parity grammar. These experiments show that pruned networks outperform networks with weight decay in cases where the starting weights were close to a solution. However, in situations where the original network was not well trained weight decay was shown to improve generalization. The convergence time for training with weight decay increased with the learning rate. Leung et al [5] have used a recursive least squares (RLS) algorithm to train the weights of a recursive neural network (RNN). After training the error covariance matrix of the RLS algorithm was used to remove unimportant weights from the network. Simulations show that this new approach is an effective joint learning-

pruning method for recurrent neural networks. Ahmed et al [6] have used the ‘Lempel-Ziv’ complexity (LZC) measure to prune artificial neural networks (ANNs). The silent pruning algorithm (SPA) prunes ANNs causing minimal disturbance to the network. SPA prunes hidden units during the training process according to their ranking computed from the LZC. Simulation tests carried out on standard benchmarking neural network problems show that SPA can produce simplified ANNs with good generalization ability.

Other techniques for improving generalization in a neural network include injecting synaptic noise [10], regularisation [11] and early stopping [12]. Hirasawa [11] have used a regularisation term for calculating second order derivatives in a Universal Learning Network (ULN) that decreases the degrees of freedom of the network. A ULN is a fully connected recurrent neural network with multiple nodes and multiple branches with arbitrary time delays. Simulation results for a hydraulically controlled robot arm have shown that the proposed method can improve generalization and avoids problems like local minima. In Giles et al [10] synaptic noise was injected into a high order recurrent neural network. Additive, multiplicative and cumulative noise was injected into the weights of a neural network where cumulative is taken to mean accumulated over time. Simulation results on the dual parity automaton problem [4] show that these methods can improve generalization and convergence simultaneously

## II. OBJECTIVES

In this paper a weight elimination procedure is used to improve generalization in recurrent neural networks. The algorithm has been developed from one described elsewhere and referred to as iTPA [7]. Unlike other implementations of the weight elimination procedure, the method used here is built into the geometry of the algorithm. There are currently no implementations of the weight elimination procedure for recurrent neural networks.

The rest of the paper is organized as follows: in section III and IV, a detailed derivation of the algorithm and an evaluation of weight sensitivity methods are presented. In section V and VI, the results of computer simulations are considered and the differences in the results tested for statistical significance. Finally, the conclusions are presented in section VII.

## III. DESCRIPTION OF THE ALGORITHM

In May et al [7], a fast tangent plane method is described for training feed-forward multilayered neural networks. This method uses the training data to define a surface in weight space. The weights are updated by moving from the current position to a point nearby the foot of the perpendicular to this surface, biased in the direction that forces small weights values to decay faster than large ones. The principal advantage of the algorithm is that it self regulates the size of the network by removing superfluous weights which can be harmful to generalization. Unlike other implementations of the weight elimination procedure, the method used here is built into the geometry of the algorithm and causes minimal disruption to the learning process. Experimental results show that a weight elimination strategy is a more effective method for improving

the generalization performance of the tangent plane algorithm than a weight growth strategy. This paper describes an equivalent implementation of the tangent plane algorithm for recurrent neural networks. A tangent plane variant of the real time recurrent learning algorithm referred to as TPA-RTRL has already been described elsewhere [13]. The detailed derivation of the algorithm follows

Consider a FRNN of units  $\{u^j\}$  (see Fig 1). For unit  $u^j$ ,  $w_j^T = [w_{j1}, w_{j2}, \dots, w_{j,(n+m+1)}]$  denotes a  $(n+m+1) \times 1$  vector of weights, where  $n$  are the number of processing units,  $m$  the number of external inputs, with one remaining input being for the fixed input bias. Let  $\phi_j$  and  $\theta_j$  denote the net input and output of  $u^j$ , and  $f$  the unit’s activation function, typically  $\tanh(x)$ . The following equations describe the FRNN at time instant  $t$

$$\theta_j^{(t)} = f(\phi_j^{(t)}), \quad j=1, 2, \dots, n \quad (1)$$

$$\phi_j^{(t)} = \sum_{i=1}^{n+m+1} w_{ji}^{(t)} z_i^{(t)} \quad (2)$$

$$[z_i^{(t)}]^T = [\theta_1^{(t-1)}, \dots, \theta_n^{(t-1)}, +1, x_1^{(t-1)}, \dots, x_m^{(t-m)}] \quad (3)$$

For the non-linear time series prediction paradigm, there is only one output unit of the FRNN. Let this output unit be denoted by  $u_1$ , with  $\theta_1^{(t)}$  at time step  $t$  being trained to mimic the teaching value  $y_1^{(t)}$ . For a given set of inputs  $\{x_i^{(t-i)}, i=1, \dots, m\}$ , we can consider  $\phi_1^{(t)}$  to be a function of the weights,  $\phi_1^{(t)} : R^{n \times (n+m+1)} \rightarrow R$ . Thus the equation  $\phi_1^{(t)} = f^{-1}(y_1^{(t)})$  defines a  $n \times (n+m+1) - 1$  surface in  $R^{n \times (n+m+1)}$ . The aim of this training procedure is to move from the current position  $a \in R^{n \times (n+m+1)}$  in weight space to the foot of the perpendicular to the tangent plane of this surface (see Fig 2)

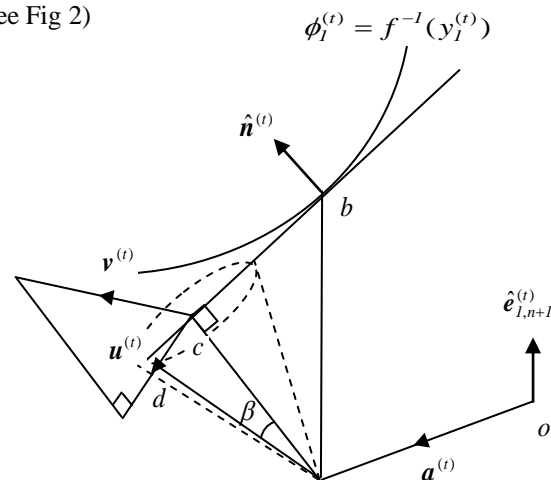

Fig. 2. Movement from the present position  $a$  to the point  $d$  inclined at an angle  $\beta$  to the perpendicular  $ac$  to the tangent plane to the constraint surface

$\phi_l^{(t)} = f^{-1}(y_l^{(t)})$  at point  $b$  in weight space  $R^{n \times (m+n+1)}$ . The vector  $\mathbf{u}$  represents the projection of the weight elimination vector  $\mathbf{v}$  orthogonally onto the normal  $\mathbf{n}$  to the constraint surface at  $b$

Let  $\mathbf{a}^{(t)} = \sum_{j,i} w'_{ji}(t) \hat{\mathbf{e}}_{ji}$  be the current vector of weights, where  $\hat{\mathbf{e}}_{ji}$  is a unit vector in the direction of the  $w_{ji}$  axis. Use the equation  $f^{-1}(y_l^{(t)}) = w_{l,n+1}^{(t)} + \sum_{i \neq n+1} w_{l,i}^{(t)} z_i^{(t)}$  to find a particular value  $w_{l,n+1}^{(t)}$  for the constant input weight  $w_{l,n+1}$  from the values  $w'_{ji}(t)$  of the other weights, so that the constraint surface  $\phi_l^{(t)} = f^{-1}(y_l^{(t)})$  contains the point  $\mathbf{b}^{(t)} = w_{l,n+1}^{(t)} \hat{\mathbf{e}}_{l,n+1} + \sum_{j,i \neq l,n+1} w'_{ji}(t) \hat{\mathbf{e}}_{ji}$ . Now, if we use the equations  $f^{-1}(y_l^{(t)}) = w_{l,n+1}^{(t)} + \sum_{i \neq n+1} w_{li}^{(t)} z_i^{(t)}$  and  $f^{-1}(\theta_l^{(t)}) = w'_{l,n+1}(t) + \sum_{i \neq n+1} w'_{li}(t) z_i^{(t)}$ , and from the definition of  $\mathbf{b}^{(t)}$ , we have

$$\begin{aligned} \mathbf{b}^{(t)} - \mathbf{a}^{(t)} &= [w_{l,n+1}^{(t)} - w'_{l,n+1}(t)] \hat{\mathbf{e}}_{l,n+1} \\ &= [f^{-1}(y_l^{(t)}) - f^{-1}(\theta_l^{(t)})] \hat{\mathbf{e}}_{l,n+1} \end{aligned} \quad (4)$$

Let  $\hat{\mathbf{n}}$  be the unit normal to the surface at  $\mathbf{b}$ , so  $\hat{\mathbf{n}} = \nabla \phi_l / \|\nabla \phi_l\|$ . The length of the perpendicular from  $\mathbf{a}$  to the tangent plane at  $\mathbf{b}$  is  $(\mathbf{b} - \mathbf{a}) \cdot \hat{\mathbf{n}}$ . If  $\mathbf{c}$  is the foot of the perpendicular from  $\mathbf{a}$  to the tangent plane at  $\mathbf{b}$ ,

$$\mathbf{c}^{(t)} - \mathbf{a}^{(t)} = (f^{-1}(y_l^{(t)}) - f^{-1}(\theta_l^{(t)})) (\hat{\mathbf{e}}_{l,n+1} \cdot \hat{\mathbf{n}}^{(t)}) \hat{\mathbf{n}}^{(t)} \quad (5)$$

The vector that is directed towards the origin and biased along the axes of the weights  $w_{ji}$  that have small weight values relative to some small positive constant  $w_a$  is  $\mathbf{v}^{(t)} = -\sum_{j,i} (w_{ji}^{(t)} / w_a) \hat{\mathbf{e}}_{ji}^{(t)} / (1 + (w_{ji}^{(t)} / w_a)^2)$ . The projection of  $\mathbf{v}^{(t)}$  onto the tangent plane is given by

$$\mathbf{u}^{(t)} = \mathbf{v}^{(t)} - (\mathbf{v}^{(t)} \cdot \hat{\mathbf{n}}^{(t)}) \hat{\mathbf{n}}^{(t)} \quad (6)$$

Thus, if  $\mathbf{d}^{(t)}$  is the point of intersection with the tangent plane of a line from  $\mathbf{a}^{(t)}$  inclined at angle  $\beta$  to the perpendicular  $ac$ , then

$$\mathbf{d}^{(t)} - \mathbf{a}^{(t)} = \|\mathbf{c}^{(t)} - \mathbf{a}^{(t)}\| \tan \beta \frac{\mathbf{u}^{(t)}}{\|\mathbf{u}^{(t)}\|} + \mathbf{c}^{(t)} - \mathbf{a}^{(t)} \quad (7)$$

Let  $\delta^{(t)} = f^{-1}(y_l^{(t)}) - f^{-1}(\theta_l^{(t)})$  be the error in the input to  $u_l$  at time  $t$ . Hence, using equations (5), (6) and (7) yields

$$\mathbf{d}^{(t)} - \mathbf{a}^{(t)} = \delta^{(t)} (\hat{\mathbf{e}}_{l,n+1} \cdot \hat{\mathbf{n}}^{(t)}) \hat{\mathbf{n}}^{(t)} + |\delta^{(t)}| (\hat{\mathbf{e}}_{l,n+1} \cdot \hat{\mathbf{n}}^{(t)}) \tan \beta \frac{\mathbf{u}^{(t)}}{\|\mathbf{u}^{(t)}\|} \quad (8)$$

However

$$\begin{aligned} \hat{\mathbf{e}}_{l,n+1} \cdot \hat{\mathbf{n}} &= \hat{\mathbf{e}}_{l,n+1} \cdot \frac{1}{\|\nabla \phi_l^{(t)}\|} \sum_{j,i} \frac{\partial \phi_l^{(t)}}{\partial w_{ji}} \hat{\mathbf{e}}_{ji} \\ &= \frac{1}{\|\nabla \phi_l^{(t)}\|} \frac{\partial \phi_l^{(t)}}{\partial w_{l,n+1}} = \frac{1}{\|\nabla \phi_l^{(t)}\|} \frac{\partial}{\partial w_{l,n+1}} \sum_{j,i} w_{ji}^{(t)} z_i^{(t)} \\ &= \frac{1}{\|\nabla \phi_l^{(t)}\|} \end{aligned} \quad (9)$$

Therefore,

$$\mathbf{d}^{(t)} - \mathbf{a}^{(t)} = \frac{1}{\|\nabla \phi_l^{(t)}\|^2} \delta^{(t)} \nabla \phi_l^{(t)} + \frac{|\delta^{(t)}|}{\|\nabla \phi_l^{(t)}\|} \tan \beta \frac{\mathbf{u}^{(t)}}{\|\mathbf{u}^{(t)}\|} \quad (10)$$

Thus, the adjustment to weight  $w_{ji}$  is given by

$$\begin{aligned} \Delta w_{ji}^{(t)} &= \frac{1}{\|\nabla \phi_l^{(t)}\|^2} \delta^{(t)} \frac{\partial \phi_l^{(t)}}{\partial w_{ji}} + \frac{|\delta^{(t)}|}{\|\nabla \phi_l^{(t)}\|} \tan \beta \frac{1}{\|\mathbf{u}^{(t)}\|} \times \\ &\left( v_{ji}^{(t)} - \frac{1}{\|\nabla \phi_l^{(t)}\|^2} \sum_{p,q} v_{pq}^{(t)} \frac{\partial \phi_l^{(t)}}{\partial w_{pq}} \frac{\partial \phi_l^{(t)}}{\partial w_{ji}} \right) \end{aligned} \quad (11)$$

where

$$\|\nabla \phi_l^{(t)}\|^2 = \sum_{j,i} \left( \frac{\partial \phi_l^{(t)}}{\partial w_{ji}} \right)^2 \quad (12)$$

and

$$\|\mathbf{u}^{(t)}\|^2 = \sum_{j,i} \left( v_{ji}^{(t)} - \frac{1}{\|\nabla \phi_l^{(t)}\|^2} \frac{\partial \phi_l^{(t)}}{\partial w_{ji}} \sum_{p,q} v_{pq}^{(t)} \frac{\partial \phi_l^{(t)}}{\partial w_{pq}} \right)^2 \quad (13)$$

and from May (2012)

$$\frac{\partial \phi_l^{(t)}}{\partial w_{ji}^{(t)}} = \sum_{m=1}^n f'(\phi_m^{(t-1)}) \frac{\partial \phi_m^{(t-1)}}{\partial w_{ji}^{(t-1)}} w_{lm}^{(t)} + \delta_{j1} z_i^{(t)} \quad (14)$$

where

$$\delta_{jl} = \begin{cases} 1, & \text{if } j = l \\ 0, & \text{otherwise} \end{cases}$$

Equation (14) holds for all units  $u_k$ ,  $k = 1 \dots n$ . Thus, we can create a dynamical system with the dynamics given by

$$\frac{\partial \phi_k^{(t)}}{\partial w_{ji}^{(t)}} = \sum_{m=1}^n f'(\phi_m^{(t-1)}) \frac{\partial \phi_m^{(t-1)}}{\partial w_{ji}^{(t)}} w_{km}^{(t)} + \delta_{jk} z_i^{(t)} \quad (15)$$

Since we assume that the initial state of the recurrent neural network has no functional dependence on the weights, we have  $\partial \phi_k^{(t=t_0)} / \partial w_{ji} = 0$ ,  $k \leq n$ ,  $j \leq n$ ,  $1 \leq i \leq n+m+1$ .

The training procedure described above is a tangent plane variant of the real time recurrent learning algorithm (RTRL) proposed by Williams and Zipser [14] for online training of recurrent neural networks. The GD-RTRL algorithm utilises the gradient information to guide the search towards the minimum training error. However, it is sensitive to the choice of a learning rate that requires careful tuning. The TPA-RTRL algorithm proposed by May et al [13] differs to the original algorithm by automatically calculating the correct step size in weight space using the method of approaching tangent planes. The improved TPA-RTRL algorithm described here includes a weight elimination procedure built into its geometry that suppresses the formation of large weight values

The angle parameter  $\beta$ , which gives the angle between the movement vector and the perpendicular to the tangent plane, requires setting to an appropriate value. Its value is preferred to be small, typically  $\tan \beta \approx 0.005$ . Tests showed that the performance of the algorithm deteriorated rapidly when  $\tan \beta$  was greater than 0.1. Network training times are much longer and the number of failures to converge more frequent. The reason for the failure to converge was that the weights became clustered too closely about the origin with average weight values  $< 0.01$ . In these circumstances individual weight updates  $\Delta w_{ji}^{(t)}$  are no longer based on the values of previous derivatives  $\partial \phi_k^{(t)} / \partial w_{ji}$ ,  $k=1, \dots, n$  over the whole trajectory from  $t = t_0$  to  $t_1$  but are driven by the training data, thus the trajectory will not follow a steepest descent path

The weight sensitivity parameter  $w_a$ , which determines the size of the push towards the origin that an individual weight  $w_{ji}^{(t)}$  will receive, also requires setting to an appropriate value.  $w_a$  is preferred to be small, typically 0.5, so that weights with small values are selected for removal from the network. An individual term  $v_{ji}^{(t)} = -(w_{ji}^{(t)} / w_a) / (1 + (w_{ji}^{(t)} / w_a)^2)$  in  $v^{(t)}$  varies according to  $(w_{ji}^{(t)} / w_a)$  in an anti-symmetric fashion. When  $|w_{ji}^{(t)}| < w_a$ , the directional term for that weight is approximately linear. On the other hand, when  $|w_{ji}^{(t)}| > w_a$ , the directional term quickly approaches to zero. Thus a weight will receive a large push when  $w_{ji}^{(t)}$  equals  $w_a$ .

The iTPA-RTRL algorithm uses the gradient vector to do a linear extrapolation of the constraint surface  $\phi_1^{(t)} = f^{-1}(y_1^{(t)})$  in order to gain a new weight vector that is hoped to be on, or at

least close, to this surface. However,  $\phi_1^{(t)} = f^{-1}(y_1^{(t)})$  is a non-trivial function of the weights, the recursive feedback activations  $\phi_i^{(t-1)}$ ,  $i = 1, \dots, n$ , themselves being a function of the weights. Thus the basic approximation that the surface can be locally approximated may only be limited to certain regions of weight space close to  $\phi_1^{(t)} = f^{-1}(y_1^{(t)})$ . Removing superfluous weight from the network using a weight elimination procedure will have the effect of constraining the weight vector to a subspace of  $R^{n \times (n+m+1)}$ . This in turn will have a smoothing effect on the constraint surface  $\phi_1^{(t)} = f^{-1}(y_1^{(t)})$  making a tangent plane approximation to this surface viable.

A potential difficulty with the iTPA-RTRL algorithm is that while learning from a large amount of data the weight change between the start of the learning phase ( $t = t_0$ ) and the end of the learning phase ( $t = t_1$ ) will not be small. The reason is that the weight update  $\Delta w_{ji}^{(t)}$  is based upon the value of the derivatives  $\partial \phi_k^{(t)} / \partial w_{ji}$ ,  $k=1, \dots, n$  over the whole trajectory from  $t = t_0$  to  $t_1$ . These derivatives are calculated recursively using a relationship that is dependent on the weights and the weights are not constant. Thus, the iTPA-RTRL algorithm can move far from the steepest descent trajectory and never return. Constraining the FRNN to small weight values might actually improve convergence behaviour as small weight values will lead to small fluctuations in the gradient vector. This in turn might lead to a more robust implementation of the TPA-RTRL algorithm as the computation of the partial derivatives  $\partial \phi_k^{(t)} / \partial w_{ji}$  is prone to arithmetic overflow errors

#### IV. ESTIMATING WEIGHT SENSITIVITY VALUES

The effectiveness of the weight elimination procedure can be measured by calculating the importance of each weight with the expectation that weights with low importance are redundant in the network. There are several methods for calculating the importance of the weights [15, 16], optimal brain damage [17], and optimal brain surgeon [18]. In the case of OBD, the saliency of removal of a weight is estimated by using the second derivative of the error function. Low saliency means low importance of the weights. OBS avoids the drawbacks of approximating the second derivatives by computing them exactly [18]. The last two methods have the disadvantage of requiring training down to the error minimum. The method adopted here is autoprune [7, 19], which avoids the disadvantage of training down to the error minimum. Autoprune uses a statistic  $t$  to allocate an importance coefficient to each weight based upon the assumption that a weight becomes zero. It can be computed at any time during the training process

$$t(w_{ji}) = \log \left( \frac{\left| \sum_t w_{ji} - \Delta w_{ji}^{(t)} \right|}{\sum_t (\Delta w_{ji}^{(t)} - (\Delta \bar{w}_{ji}))^2} \right) \quad (16)$$

In the above formula, sums are over all training examples  $t$  of the training set, and the overline means arithmetic mean over all examples. A large value of  $t_{ji}$  indicates high importance of weight  $w_{ji}$ . May et al [7] have demonstrated using autoprune the effectiveness of the weight elimination procedure in a multi-layer feed forward neural network.

### V. COMPUTER SIMULATIONS

Comparative tests were performed on the iTPA-RTRL and TPA-RTRL algorithms, and the original GD-RTRL algorithm using different network sizes and initial conditions. In order to assess the generalization performance of the iTPA-RTRL algorithm, a weight decay procedure was utilized with the original GD-RTRL algorithm, which has been shown to improve generalization in second order recurrent neural networks [4].

The comparison was done based on the performance for the following benchmark neural network datasets; the Henon map time series [20], the continuous stirred tank reactor [21], and the non-linear dynamic plant [22]. The Henon map time series was used to analyse the effect of changing the weight sensitivity parameter  $w_a$  on the ability of a single layer FRNN to generalize. The continuous stirred tank and non-linear dynamic plant problems were chosen to establish the degree to which each learning algorithm used in this study has succeeded in removing superfluous weights from the network.

#### A. Simulation Problems

The Henon map problem is a chaotic time-series prediction problem. The time series is computed by

$$x^{(t+1)} = I - c(x^{(t)})^2 + bx^{(t-1)} \quad (17)$$

Where  $b = 0.3$ ,  $c = 1.4$ , and  $x^{(1)} = x^{(2)} = 0.6313354$ . The objective of the simulation is to train a single layer FRNN with one input and one output to model the chaotic series generated by (17). Since  $x_{max} = 1.272967$  and  $x_{min} = -1.284657$ , the input values were scaled in the range  $[-1, 1]$ .

The non-linear dynamic plant problem is a high order non-linear system introduced in Narendra and Parthasarathy [22]. It is modeled by the following discrete time equation

$$y^{(t)} = \frac{y^{(t-1)}y^{(t-2)}y^{(t-3)}u^{(t-1)}[y^{(t-3)} - I] + u^{(t)}}{I + [y^{(t-2)}]^2 + [y^{(t-3)}]^2} \quad (18)$$

Where  $y^{(t)}$  is the model output at time  $t$ . A single layer FRNN with one output unit and two input units was trained. The training data was generated using a random input signal uniformly distributed over the interval  $[-1, 1]$ .

The Van de Vusse reaction in a continuous stirred tank reactor (CSTR) can be modelled by the following discrete-time nonlinear system introduced by Hernandez and Arkun [21]

$$y^{(t)} = c_1 + c_2 u^{(t-1)} + c_3 y^{(t-1)} + c_4 [u^{(t-1)}]^3 + c_5 y^{(t-2)} u^{(t-1)} u^{(t-2)} \quad (19)$$

Here  $y^{(t)}$  is the product concentration and  $u^{(t)}$  the scaled reactant at time step  $t$ . The input  $u^{(t)}$  has been normalized to

$0 \leq u^{(t)} \leq 1$ , and the parameters of the system are  $c_1 = 0.558$ ,  $c_2 = 0.538$ ,  $c_3 = 0.116$ ,  $c_4 = -0.127$ , and  $c_5 = -0.034$ . A single layer FRNN with one output unit and two input units was trained. The training data was generated using a random input signal uniformly distributed over the interval  $[0, 1]$ .

#### B. Network Initialization

The GD-RTRL algorithm requires two parameters that need to be set, the learning rate  $\eta$  and weight decay rate  $\lambda$ . Preliminary tests showed that the best results with the Henon map problem were obtained with  $\eta = 0.01$  and  $\lambda = 0.000001$ . For the continuous stirred tank and non-linear plant problems,  $\eta = 0.1$  and  $\lambda = 0.000001$ . The iTPA-RTRL algorithm also requires two parameters to be set: the angle parameter  $\beta$  and the weight sensitivity parameter  $w_a$ . For the Henon map problem:  $\tan \beta = 0.01$ . The weight sensitivity parameter was set to different values in  $\{0.5, 1.0, 2.0\}$ . For the continuous tank and non-linear plant problems,  $\tan \beta = 0.05$  and  $w_a = 1.0$ . Both algorithms require the weight connections of the neural network to be set. In all the tests carried out the weight connections were initialized to random values in the range  $[-0.5, 0.5]$ .

#### C. Discussion of Results

*Henon map time series.* The first test is a classical deterministic one-step-ahead prediction problem. The network used was a single layer FRNN with the number of processing units varied according to [8, 21, 26]. 20 trials were made with any failed trials excluded from the results. The error metric used was the mean square error obtained by averaging the square error over 1000 time steps. Network training was terminated when the mean square error on the training set was reduced to below 0.001 or 500,000 time steps trained. The ability of the network to generalize was measured over 1000 time steps after convergence had occurred.

TABLE I. FINAL TEST ERROR AND NUMBER OF STEPS TO CONVERGENCE FOR DIFFERENT VALUES OF THE PARAMETER  $w_a$

$w_a$	Units = 6		Units = 9		Units = 12	
	MSE $\times 10^2$	Steps $\times 10^3$	MSE $\times 10^2$	Steps $\times 10^3$	MSE $\times 10^2$	Steps $\times 10^3$
0.5	1.27	65	1.05	63	1.26	61
1.0	0.98	65	1.07	63	1.33	64
2.0	1.02	60	1.36	66	1.39	76

Table 1 shows the mean square error and the average number of steps to converge for different values of the weight sensitivity parameter  $w_a$  in the iTPA-RTRL algorithm. It was found that the generalization performance of the FRNN improved with decreasing values of  $w_a$ , except in the smallest network where it was found to be worse. This result is not surprising as selective pruning of weights in a small network structure is unlikely to improve the representational capacity of the network. It was also found that generalization performance declined with the size of the network. This was particularly noticeable for values of the weight sensitivity parameter greater than 0.5. Generalization was found to be



independent of the size of the network for the smallest value of  $w_a$ . This result suggests that selective pruning of weights implemented using small values of the parameter  $w_a$  have produced parsimonious networks capable of good generalization behavior.

A further test was carried out to assess the effectiveness of using a weight elimination procedure to produce ‘good’ network architectures. Weight sensitivity values based on  $t_{ji}$  statistic were computed during the last 1,000 time steps trained. Weights were considered to have low sensitivity values if their corresponding  $t_{ji}$  statistic was 50% of the mean value, which has been adapted from the pruning schedule iPrune [19]. Network training was terminated after 5,000,000 time steps. The ability of the network to generalize was measured over 1,000 time steps after convergence had occurred

TABLE II. FINAL TEST ERRORS AND % NUMBER OF WEIGHTS WITH LOW SENSITIVITY VALUES IN DIFFERENT SIZE NETWORKS FOR THE HENON MAP.

	Units = 6		Units = 9		Units = 12	
	MSE $\times 10^2$	n%	MSE $\times 10^2$	n%	MSE $\times 10^2$	n%
iTPA-RTRL	0.039	21.87	0.008	13.03	0.013	12.28
TPA-RTRL	0.039	24.46	0.012	13.15	0.036	13.80
GD-RTRL	0.024	26.49	0.013	12.68	0.022	12.61

Table 2 shows the mean square error and the percentage number of weights with low sensitivity values eligible for removal from the network. It was found that the new iTPA-RTRL algorithm gave the best generalization performance except in the smallest network where it was no better than the TPA-RTRL algorithm. The TPA-RTRL algorithm gave the worst performance. The poor generalization of both tangent plane algorithms in the smallest network is probably due to oscillatory behavior near a solution caused by a large step size. It was also found that networks trained by the iTPA-RTRL algorithm had the smallest percentage number of weights with low sensitivity values. The results suggest that a weight elimination strategy effectively discriminates between active and inactive weights in the network thus improving generalization performance. Figures 3 and 4 show the fit for the iTPA-RTRL and GD-RTRL algorithms using an FRNN with 12 processing units after 500,000 time steps. Clearly the fit is not exact but this is quite reasonable considering the type of input data used.

*Continuous stirred tank reactor.* The second test is a discrete-time nonlinear system introduced by Hernandez and Arkun [21]. The network used was a single layer FRNN with the number of processing units varied according to [8, 21, 26]. The error metric used was the mean square error obtained by averaging the square error over 100 time steps. Weight sensitivity values based on the  $t_{ji}$  statistic measured over the last 100 time steps trained. Weights were considered to have low sensitivity values if their corresponding  $t_{ji}$  statistic was 50% of the mean value. Network training was terminated after 50,000 time steps.

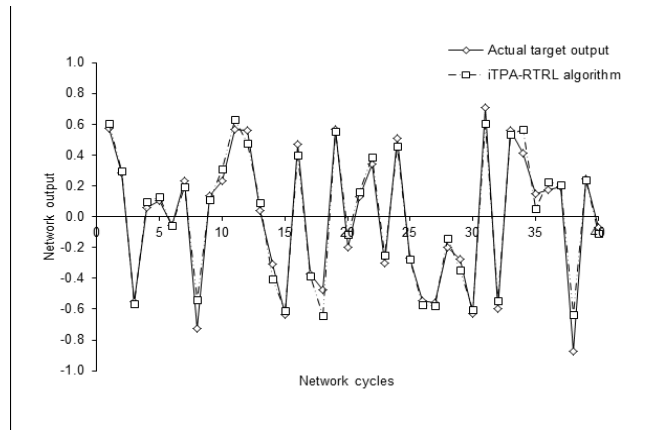

Fig. 3. Typical convergence behavior of the new iTPA-RTRL algorithm on the Henon map time series problem.

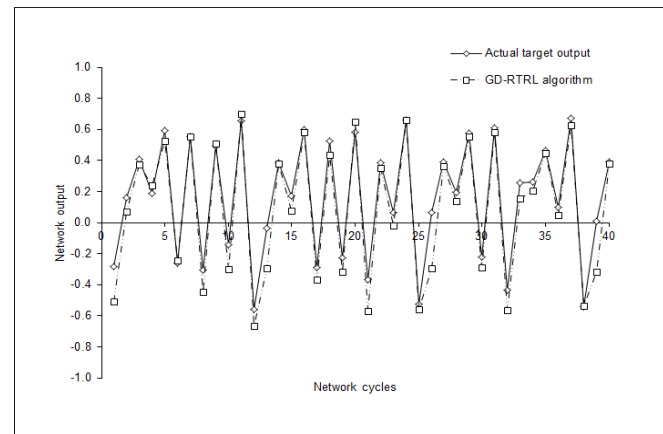

Fig. 4. Typical convergence behavior of the original GD-RTRL algorithm on the Henon map time series problem

Table 3 shows the mean square error and the percentage number of weights with low sensitivity values. It was found that the iTPA-RTRL algorithm gave improved generalization relative to the GD-RTRL algorithm. The TPA-RTRL algorithm gave the worst performance. Generalization was found to be independent of the size of the network. It was also found that the iTPA-RTRL and GD-RTRL algorithms produced networks with the smallest number of weights with low sensitivity values. The results suggest that training networks with weight regularisation is better than training without weight regularisation. Fig 5 and 6 show the fit for the iTPA-RTRL and GD-RTRL algorithms using an FRNN with 12 processing units after 50,000 time steps. Clearly the fit of the iTPA-RTRL algorithm is very good despite the type of the input data used.

TABLE III. FINAL ERROR AND % NUMBER OF WEIGHTS WITH LOW SENSITIVITY VALUES IN DIFFERENT SIZE NETWORKS FOR THE CONTINUOUS STIRRED TANK

	Units = 6		Units = 9		Units = 12	
	MSE $\times 10^2$	n %	MSE $\times 10^2$	n %	MSE $\times 10^2$	n %
iTPA-RTRL	0.037	20.87	0.035	9.97	0.036	7.05
TPA-RTRL	0.054	21.69	0.055	13.27	0.054	9.25
GD-RTRL	0.041	17.75	0.040	9.58	0.043	7.96

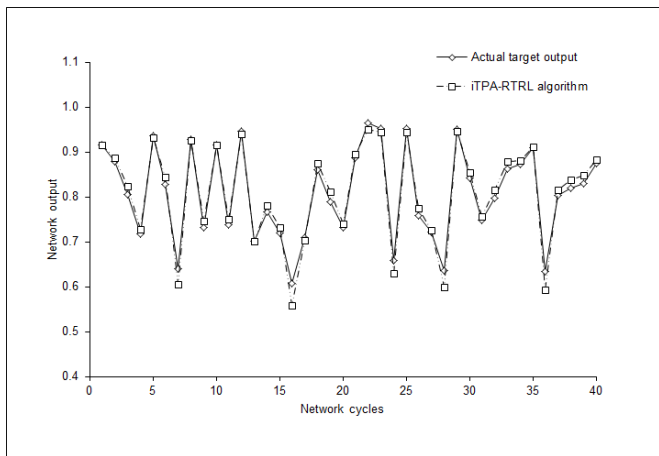

Fig. 5. Typical convergence behavior of the new iTPA-RTRL algorithm on the continuous stirred tank problem

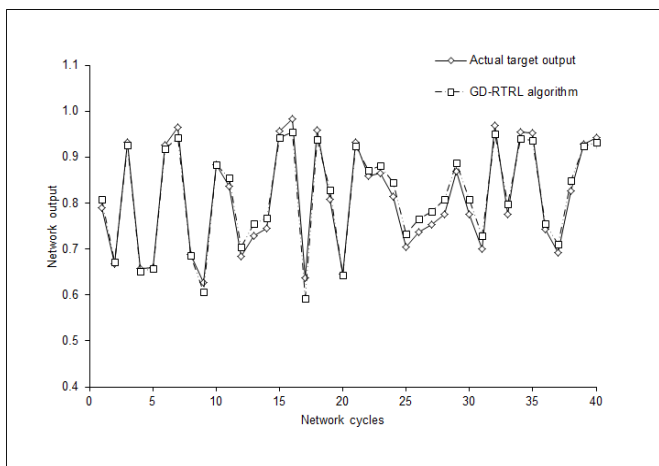

Fig. 6. Typical convergence behavior of the original GD-RTRL algorithm on the continuous stirred tank problem

*Non-linear dynamic plant.* The final test is a discrete-time nonlinear system introduced by Narendra and Parthasarathy [22]. Once again the network used was a single layer FRNN with the processing units varied according to [8, 21, 26]. The error metric used was the mean square error obtained by averaging the square error over intervals of 100 time steps. Network training was terminated after 50,000 time steps trained. Weight sensitivity values based on  $t_{ji}$  statistic were computed during the last 100 time steps of the training phase.

Table 4 shows the mean square error and percentage number of weights with low sensitivity values. It was found that the iTPA-RTRL algorithm gave good generalization performance across a range of network sizes. The GD-RTRL algorithm gave the worst performance. Generalization performance was found to deteriorate with the size of the network. This was particularly noticeable in networks trained by the TPA-RTRL algorithm. It was also found that the iTPA-RTRL algorithm produced networks with fewer redundant weights compared with the original algorithm. The results suggest that using a weight elimination procedure during training is better than not using it at all. Fig 7 and 8 show the fit for the iTPA-RTRL and GD-RTRL algorithms using an FRNN with 12 processing units after 50,000 time steps. Clearly the

fit of both algorithms is very good considering the input data used (high spectral content).

TABLE IV. FINAL ERROR AND % NUMBER OF WEIGHTS WITH LOW SENSITIVITY VALUES IN DIFFERENT SIZE NETWORKS FOR THE NON-LINEAR DYNAMIC PLANT

	Units = 6		Units = 9		Units = 12	
	MSE $\times 10^2$	n%	MSE $\times 10^2$	n%	MSE $\times 10^2$	n%
iTPA-RTRL	4.39	14.33	4.34	7.85	4.75	6.15
TPA-RTRL	4.33	15.42	4.35	9.78	4.85	7.74
GD-RTRL	4.65	13.11	4.88	7.99	4.74	6.02

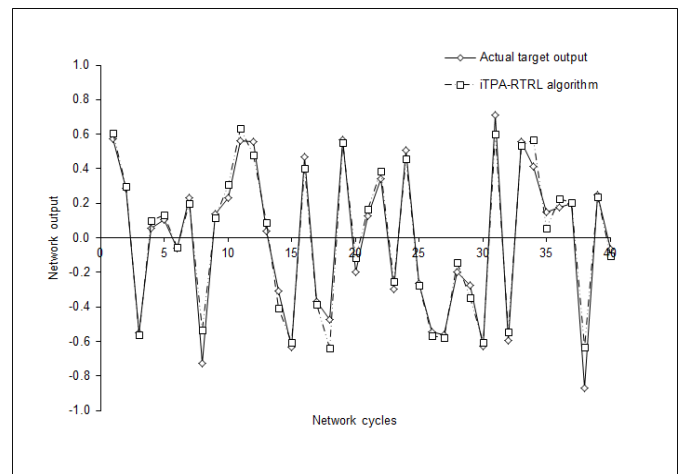

Fig. 7. Typical convergence behavior of the new iTPA-RTRL algorithm on the non-linear dynamic plant problem

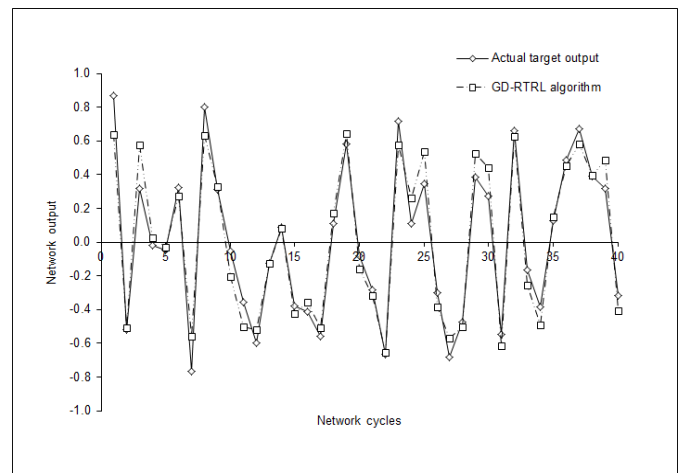

Fig. 8. Typical convergence behavior of the original GD-RTRL algorithm on the non-linear dynamic plant problem

## VI. COMPARISON OF THE DIFFERENT ALGORITHMS

In order to determine whether the difference in the results is statistically significant, we perform some hypothesis tests. The test used was a standard t-test with the sample of test errors from the iTPA-RTRL algorithm compared with the corresponding sample from the original TPA-RTRL algorithm for each dataset used in the study. A second test was carried

out by comparing these test results with the GD-RTRL algorithm on the same set of problems. For the correct application of the t-test, it was necessary to take the logarithm of the test errors (since the test errors have log-normal distribution) and remove any outliers, following the same procedure in [19]. The resulting samples were tested for normality using the Kolmogorov-Smirnov test.

TABLE V. RESULTS OF A T-TEST COMPARING THE MEAN TEST ERRORS OF THE DIFFERENT ALGORITHMS

Problem	Processing units	O	I	(a)	(b)	(c)
Henon map	9	1	1	L 3.54	L 2.33	-
Stirred tank	9	1	2	L 11.52	L 5.73	G 6.20
Non-linear plant	9	1	2	-	-	-

Note: The entries show differences that are statistically significant on a 10% level and dashes mean no significance found. Column (a): iTPA-RTRL (“L”) vs. TPA-RTRL (“T”). Column (b): iTPA-RTRL vs. GD-RTRL (“G”). Column (c): TPA-RTRL vs. GD-RTRL

The results are tabulated in Table 5. Dashes mean differences that are not significant at the 10% level i.e. the probability that the differences are purely accidental. Other entries indicate the superior algorithm (e.g. new iTPA-RTRL algorithm - L, TPA-RTRL algorithm - T, GD-RTRL algorithm - G), and the value of the t statistic. Column (a) gives a comparison between the new iTPA-RTRL algorithm and the TPA-RTRL algorithm. The results show two times L is better (Henon map and continuous stirred tank) and once no statistical difference (non-linear dynamic plant). This suggests that training using weight elimination is better than training with no weight regularisation at all. Column (b) and (c) give comparisons between the new iTPA-RTRL and original TPA-RTRL algorithms, and the GD-RTRL algorithm. The results show three times no statistical difference, twice L is better and once G is better. This suggests that the generalization performance of the new iTPA-RTRL algorithm is superior, and that training RNN using weight elimination or weight decay is better than training with none at all, which is the situation with the TPA-RTRL algorithm.

## VII. CONCLUSIONS

A new variant of the tangent plane algorithm referred to as iTPA-RTRL is proposed for online training of recurrent neural networks. This algorithm automatically adjusts the step size by approaching tangent planes to constraint surfaces. A weight elimination vector is projected onto the tangent plane with the expectation that the algorithm will prune superfluous weights from the network without causing much disturbance during network training. The iTPA-RTRL algorithm requires two parameter to set manually; the angle parameter  $\beta$  and the weight sensitivity parameter  $w_a$ . Small values of  $w_a$  which implement a weight elimination procedure are preferred in large network structures. Increasing the value of  $w_a > 1.0$  has a deleterious effect on generalization and produces slower convergence.

Comparative tests were carried out using the new iTPA-RTRL and TPA-RTRL algorithms and the GD-RTRL algorithm with weight decay. The neural network benchmark datasets used were the Henon map [23], the continuous stirred tank [24] and the non-linear dynamic plant [25].

The results show that the iTPA-RTRL algorithm was two times better (Henon map and continuous stirred tank) than the TPA-RTRL algorithm, and two times better (Henon map and continuous stirred tank) than the GD-RTRL algorithm with weight decay. It was also found that the iTPA-RTRL algorithm pruned the smallest percentage of weights from the network. This result suggests that a weight elimination strategy is an effective method for discriminating between active and inactive weights and actually results in better generalization performance.

## VIII. FUTURE WORK

This paper shows that the newly developed improved tangent plane algorithm for recurrent neural networks gives improved generalization performance relative to the gradient descent real time recurrent learning algorithm with weight decay. In situations where time varying signals are required, such as grammatical inference or process control modelling, the sequential learning ability of the improved tangent plane algorithm might be the preferred method.

## REFERENCES

- [1] Shaohua Tanb, Ah Chung Tsoi, “Recurrent neural networks: a constructive algorithm and its properties”, *Neurocomputing*, vol. 15, 1997, pp. 309 - 326
- [2] Subrahmanya, N., Yung, C. Shin, “Constructive training of recurrent neural networks using hybrid optimization”, *Neurocomputing*, vol. 73, 2010, pp. 2624 – 2631
- [3] Puma-Villanueva, W.J., Santos, E.P., Zuben, F.J., “A constructive algorithm to synthesize connected feedforward neural networks”, *Neurocomputing*, vol. 75, 2012, pp. 14 – 32
- [4] Giles, C.L., Omlin, C.W., “Pruning recurrent neural networks for improved generalization performance”, *IEEE transactions on neural networks*, 1992, vol. 5, no. 5, pp. 848
- [5] Chi-Sing Leung, Lai-Wan Chan, “Dual extended Kalman filtering in recurrent neural network,” *Neural Networks*, vol. 16, 2003, pp. 223-239
- [6] Ahmed, S.U., Shahjahan, M.D., Kazuyuki, M., “A Lempel-Ziv complexity based neural network pruning algorithm,” *Int. J. Neur. Syst.* 2011 (5), pp. 427 – 441
- [7] May, P., Zhou, E., and Lee, C.W., “A comprehensive evaluation of weight growth and weight elimination methods using the tangent plane algorithm”, *Advanced computer science and applications*, 2013, vol. 4. no. 6
- [8] P.M. Williams, “Baysian regularisation and pruning using a Laplacian prior,” *Technical report*, (312), 1994
- [9] P.O. Hoyer, “Non-negative matrix factorisation with sparseness constraints,” *Journal of machine learning research*, (5): 1457 – 1469. 2004
- [10] Jim, K., K., Giles, C.L., Horne, B.G., “Synaptic noise in dynamically driven recurrent neural networks: convergence and generalization”, Technical report, UMIACS-TR-94-89 and CS-TR-3322 Institute for advanced computer science, 1994, University of Maryland, College Park
- [11] Hirasawa, K., Kim, S., Hu, J., Han, M., and Jin, C., “Improvements of generalization ability for identifying dynamical systems by using universal learning networks”, *Neural Networks*, vol 14 2001, pp1389 - 1404
- [12] Giles, C.L, Lawrence, S, Ah Chung Tsoi, “Noisy time series prediction using recurrent neural networks and grammatical inference”, *Journal of machine learning*, (44), 2001, pp 161-183

- [13] May, P, Zhou, E., and Lee, C.W, "Learning in fully recurrent neural networks by approaching tangent planes to constraint surfaces", *Neural Networks*, vol 34, 2012, pp. 72-79.
- [14] Williams, R.J, and Zipser, D., "A learning algorithm for continually running recurrent neural networks", *Neural Computation*, 1989, vol.1, no. 2, pp.270-280.
- [15] Mozer, M. C, and Smolensky, P., "Skeletonisation: a technique for trimming the fat from a neural network via relevance assessment", *Advances in neural information processing*, 1989, (1), pp. 107-115
- [16] Karnin, E., "A simple procedure for pruning back-propagation trained neural networks", *IEEE trans on neural networks*, 1990, vol. 1, no. 2, pp. 329 – 242
- [17] B. Hassibi, and D.G. Stork, "Second order derivatives for network pruning," *Advances in neural information processing systems*, vol.5, 1993, pp. 164-171.
- [18] Y.L, LeCun, J.S., Denker, and S.A. Solla, "Optimal brain damage," *Advances in neural information processing systems*, vol.2, 1990, pp. 598-605.
- [19] L. Prechelt, "Connection pruning with static and adaptive pruning schedules," *Neurocomputing*, Volume 16, Issue 1, 1997, pp. 49-61
- [20] Mak, M.W., Ku, K.W., and Lu, Y.L., "On the improvement of the real time recurrent learning algorithm for recurrent neural networks", *Neurocomputing*, 1999, vol 24, issues 1-3, pp. 13-36.
- [21] Hernandez, E., and Arkun, T., "Stability of non-linear polynomial ARMA models and their inverse", *International journal of control*, 1996, 63, 885-906
- [22] K.S Narandra, and K. Parthasarathy, "Identification and control of dynamical systems using neural networks," *IEEE transactions on neural networks*, 1 (1), 4 1990.

# Development of a Local Entomological Database for Education and Research using Simulation (Virtual) Methods

Emad I. Khater<sup>1</sup>, Mona G. Mahmoud, Enas H.

Ghallab, Magdi G. Shehata

<sup>1</sup>Department of Entomology,  
Faculty of Science,  
Ain Shams University,  
Cairo, Egypt

Yasser M. Abd El-Latif

<sup>2</sup>Department of Mathematics,  
Faculty of Science,  
Ain Shams University,  
Cairo, Egypt

**Abstract**—Bioinformatics has been regarded as one of the rapidly-evolving fields with enormous impact on the history of life and biomedical sciences. It is an interdisciplinary science that integrates life sciences, mathematics and computer science in order to extract meaningful biological insights from large data sets of raw DNA and protein sequences. Our objective was the development of an entomogenomics database (provisionally named EntomDB) for education and research in entomology (entomology is the science of insects). This DB includes DNA/protein sequence data selected from genomes of major insect models of importance in biology and biomedical research. EntomDB will represent a customized easy, interactive and self-learning resource tool for beginner users in poor-resource settings. This will enable the users to learn basic skills in bioinformatics and genomics, needlessly to search through the numerous databases currently available on the World-Wide Web with their complex interfaces and contents. EntomDB will help students and young researchers in studying the primary structure, splicing, and translation and predict function of different genes by using simple simulation methods. It is also designed to be adaptable to work off-line, in case no internet connection is available. EntomDB is primarily designed for entomology discipline; however, it can easily be adapted for other disciplines in life and biomedical sciences. EntomDB will have important educational and developmental outcomes in promoting bioinformatics learning in the developing world and provide affordable first-level training for advanced degree and research levels.

**Keywords**— *Bioinformatics; local database; entomology*

## I. INTRODUCTION

Bioinformatics and genomics are two of the modern life sciences that are rapidly evolving and changing the history of science. Bioinformatics is defined in the broadest sense as the application of computation in biology to handle, manage and analyze large data sets in short time with high speed and accuracy. It is an interdisciplinary science that strongly links life sciences, molecular biology, mathematics and computer science.

It has been a powerful tool in the development of genomics and related sciences and a major tool for gaining new insights of biological data. Bioinformatics has become a crucial area of development and investment for major interest groups in

academia, industry and governments, with multi-billion US dollars investments worldwide in Europe, USA and Asia [1], [2], [3], [4], [5]. Bioinformatics, as quoted from Hwa Lim [6]:

"Bioinformatics, which makes biotechnology predictive, is the discipline that concerns with the study of information content and information flow in biological systems. Understandably, it first became viable only in the second half of the 1980s, after the beginning of the genome initiative and advances in computer technologies. Any earlier would have been rather premature, except for the study of living systems as information systems and modest efforts. Due in part to the avalanche of genetic data from genome and proteome projects and from the capability to collect other medical and healthcare data, bioinformatics deals primarily with these data... it is thus not surprising that many people define bioinformatics as collection, analysis, management and dissemination of biological (medical and healthcare) data"... The process can be repeated, but the point is clear. This is one reason why creation of databases is one of the most active activities in bioinformatics."

Based on these assertions, each part of Bioinformatics definitions will be perceived differently by different users [6].

This genomics revolution has been sparked by the availability of huge data of raw genome sequences and the outcome of various analyses, which necessitated/led to parallel advancements in biotechnology platforms and tools, the most important of which is bioinformatics. This intimate and mutual interrelationship between genomics and bioinformatics is so obvious, that we cannot separate the two from each other.

Genomics is the study and analysis of genomes (genome is the entire genetic material of an organism, which acts as the blueprint for this organism's functioning and life). With the sequencing of the human genome in 2001 [7], [8] (one of the most important scientific achievements in the history of science) there has been an explosion of genome sequencing projects and related sciences. The sequenced genomes include mouse, fruit flies, worms and yeast as well as microbes. Estimates show that the GenBank and molecular databases contain gene/protein sequences and related biological information of thousands of organisms from all biological taxa. These huge repositories of data are categorized into 14

categories with a total over 1000 databases (<http://www.oxfordjournals.org/nar/database/a>). All these data and databases are easily and freely accessible from the GenBank (<http://www.ncbi.nlm.nih.gov>) or as downloadable FTP files. There are 80-190 billion nucleotide bases (the measuring unit of gene sequence) in the GenBank, which doubles almost every 2 months. According to recent information at NCBI (National Center for Biotechnology Information) (last accessed March 22, 2011), the genome sequencing projects are reaching the 10000 limit at different stages: completed, in-assembly, or in-progress. There are 731 eukaryotic nuclear genomes including 71 insect genome sequencing projects, of which two are completed, 44 in assembly and 25 in-progress. The NCBI Entrez Gene contains data of >5.4 million genes of over 6200 organisms, which are accumulated and maintained through collaboration of many international partners [9].

Currently there are over 1200 bioinformatics links collected in a specific directory. This directory is a compilation of molecular biology servers, bioinformatics tools and online resources. The availability of such tools has enormously shifted science, from the laboratory-based to the information-based with fast and easy communication between different laboratories in the world [10], [11], [12].

Early practitioners in bioinformatics were self-taught to solve specific problems in their research. With the current revolution in biological research and the key role played by bioinformatics, it has become crucial to have new generations of graduates, which are equipped with a broad range of skills in basic and molecular biology, computational biology and mathematics to carry out the huge tasks set out by modern biology. A major consequence to this urgent need was that many universities have adopted educational and research programmes in bioinformatics and genomics that include a range of theoretical and practical skills to link experimental biology to computational biology [13]. Many of these training programmes can be conducted online, to overcome the obstacles of distance and resources.

According to the level of use and expertise, users of bioinformatics can be classified into three categories from the beginner to the expert [13]:

Super-users, with good knowledge and understanding of basic tools, but have no programming or (DB)-developing skills,

Power-users, with good knowledge and understanding of basic tools, underlying algorithms, with good programming and DB-developing skills,

Bioinformaticians, those that can develop, implement algorithms, develop new tools and software, simulate and model and use IT systems to manage and extract biological information from raw sequence data.

The British QAAA (Quality Assurance and Accreditation Agency) review identified the skills needed for biology graduates, which include solving problems using computers and apply electronic means as source of information and communication as well as learning quantitative and qualitative methods. Based on the level of learning and mastering these

skills, graduate students are classified into threshold or minimum standard and good standard students [13].

For the developing world, as in Egypt, for example, the need to apply such approaches of *in silico* biology (computational and bioinformatics) that applies a great deal of computer work and predictive analysis of online data is rather crucial than for the developed world. This because of the serious lack of expertise and resources to carry out basic and advanced research in genomics and bioinformatics that are essential tools in modern biology, in particular the use of biotechnology in all fields of life science and society affairs. Such approach of online and computer-based learning will produce new generations with basic understanding of genomics and bioinformatics methods and principles applied in various life science fields and services. Through such first-level learning, they will be able to move from under super-users to high levels of power-users and experts. These future graduates will be the main source of skilled experts and users that are urgently needed for academia and industry.

The urgency of the critical situation of bioinformatics in Egypt is well reflected in a specialist document of the National Specialized Councils, an offshoot from the Presidential Department in 2002/2003. This document clearly highlighted the serious gaps in Egypt in bioinformatics teaching and research, and the crucial need to develop a focused educational and research programmes in bioinformatics. This is in the light of its global importance in biotechnological applications and investments. Of the recommendations of this expert committee are:

- 1) *Development of bioinformatics education system,*
- 2) *Increasing research programmes in bioinformatics both in the laboratory and online,*
- 3) *Linking Egyptian programmes to international resources, instead of replicating them.*

This urgent need for teaching and research in bioinformatics as expressed at the highest political level in the country, the proposed project to develop a system that is easy and accessible to first-level users in Egypt was initiated to be the first in its kind in Egypt, with the potential probability to be further distributed in the Arabic region.

Therefore, constructing a local customized entomological database able to collect, organize and deal with the volume and complexity of data relevant to the important model insect species will be a great challenge in entomology field. Building a local specialized database including DNA/protein sequences relevant to the selected insect species will significantly facilitate learning basic skills in bioinformatics without the need to search within over than 1000 molecular databases currently available on the World Wide Web (www).

## II. MATERIALS AND METHODS

### A. Approach:

Insects are considered as the largest and the most widely-distributed group of animals on earth. At present, there are over 71 sequenced insect genomes that are freely accessible from the GenBank (<http://www.ncbi.nlm.nih.gov>) including the fruit fly *Drosophila melanogaster* (a major model for scientific

research), the mosquitoes *Anopheles gambiae* and *Culex pipiens* (as disease carriers for both animal and human), the locust *Locusta migratoria* and the red flour beetle *Tribolium castaneum* (as harmful and destructive pests of many economic plants) and the honey bee *Apis mellifera* and the silk worm moth *Bombyx mori* (as beneficial insects important in agriculture and industry).

The proposed database is a collection of gene sequence data obtained from major genome databases as the GenBank (<http://www.ncbi.nlm.nih.gov>) and specific insect genome databases such as the Flybase (<http://www.flybase.org>) of the fruit fly *D. melanogaster* and Anobase (<http://www.anobase.org>) (or [vectorbase.org](http://vectorbase.org)) of the mosquito *An. gambiae*. The gene sequence data and relevant information were fed into Microsoft SQL Server 2005. These data include: gene nucleotide sequence (genomic, cDNA, mRNA) in a FASTA file format; sequence identifiers (GenBank identifier, accession number, sequence length etc.); amino acid sequence of the protein encoded by this gene or a translation of the sequence in all possible reading frames and other relevant data.

### B. Architecture:

Gene sequences of small size, e.g. 200 bp (bp= base pairs; it is the measuring unit of gene nucleotide sequence) were used to test the system. To train the system, basic procedures of searching, retrieving and analyzing a given gene sequence were performed. The type of information obtained, results, speed and accuracy of the system were assessed and compared to similar functions and results when using the parent global system to perform the same procedures and queries.

### C. Identification of the intron splice junctions and mRNA translation:

Almost all eukaryotic genes contain intervening non-protein coding sequences or introns interrupting the coding regions or exons. After removal or splicing of introns, exons will be linked together in processed messenger RNAs (mRNAs) ready for translation to proteins. There are at least eight different kinds of intron splice sites or junctions that have been found in eukaryotic genes. The GU-AG-intron is the predominant type associated with eukaryotic protein-coding genes. This GU-AG type gets its name from the fact that the intron 5'-splice site or donor starts with a GU (GT) and 3'-splice site or acceptor ends with an AG. In addition, the intron sequences between the donor and acceptor sites bases have specific consensus sequence.

The splice sites or junctions of introns were identified using the method described [14]. The probability of a "GU" as a splice junction was computed from the flanking (preceding and succeeding) nucleotides. The potential splice junctions were printed in order from most to least likely, using the first character index of value 1. This method is commonly used instead of Perl indices using the first character index of value 0. Further, the programme used makes use of Perl treatment of

strings, in that stepping off the left or right end of a string is allowed; the result is simply the null string.

After identification and removal of introns, and conjoining of exons, the resultant contiguous string of nucleotides or the open reading frame (ORF) of the gene will be translated to amino acid sequence of a given protein or a polypeptide. Therefore, translation is also known as the process of converting the information from the nucleotide sequences in the mRNA to the amino acid sequence encoding for a protein or a polypeptide.

The programme outlined [14] is used for the conceptual translation of an ORF string of nucleotides to amino acids. It prints all three reading frames in the forward or sense direction, skipping nucleotides at the beginning to produce the additional frames and ignoring the nucleotides at the end that do not form a group of 3 or codon (a codon; every 3 nucleotides correspond to an amino acid). It should also be noted that the genetic code is degenerate; there are some amino acids that are encoded by more than one codon.

## III. RESULTS & DISCUSSION:

### A. The training gene set and basic processes:

Our local database, EntomDB includes information on DNA/protein sequences of different genes selected from major insect models. We have imported some biological operations to study the structure and function of each gene. At present, the local customized database includes a training set of eighteen gene sequences with all its operations successfully achieved (Fig. 1).

According to the central dogma of molecular biology (Fig. 2), the genetic material (DNA) present within the cell nucleus is firstly transcribed into mRNA (an intermediate state less stable than DNA), which is then transported into the cytoplasm to be translated into amino acids, the building unit of the proteins that will perform different cellular functions. Both biological processes of DNA transcription and RNA translation are reported by our database for each inserted gene. Splicing is an essential step of RNA transcript processing prior to translation, which leads to excision of introns, which are then removed and exons are joined together to form a contiguous gene transcript. This step takes place for most of eukaryotic mRNAs before they can be used to produce correct proteins through translation. Nearly all eukaryotic nuclear introns begin with the nucleotide sequence GT (donor site) and end with AG (acceptor site) (the GT-AG rule) (Fig. 3). At the time of splicing, the intron is composed of RNA not DNA, so the beginning of the sequence is GU not GT (Fig. 4). For mRNA translation, there are 6 possible reading frames (3 frames for each strand of the two DNA strands of a gene). The reading frame or ORF that will be translated into a contiguous string of amino acids was manually selected. This ORF starts with ATG codon of the amino acid methionine (Met or M for short) and ends with one of 3 stop codons, UAG or UAA or UGA.



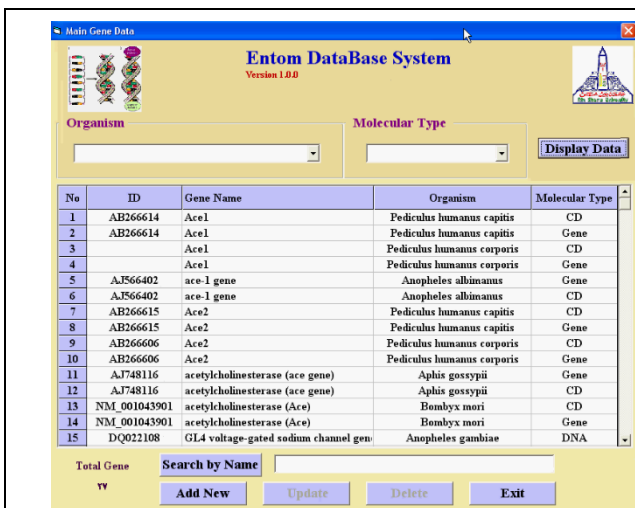

Fig. 1. A screen shot of the database interface including a number of genes from different organisms.

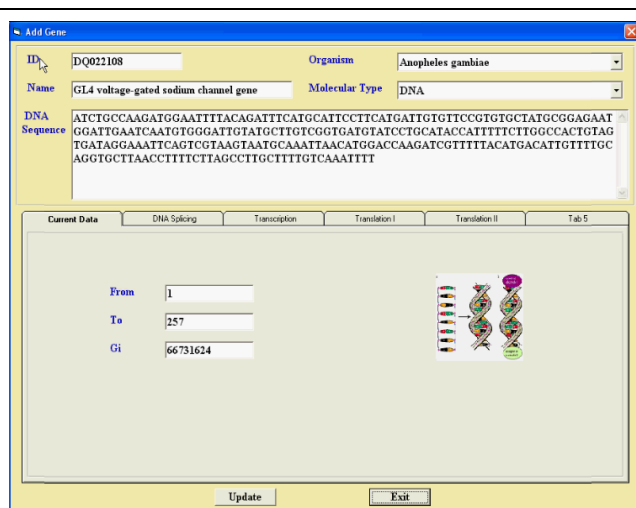

Fig. 2. A screen shot each gene showing its sequence information, Genbank ID, the source organism, molecular type.

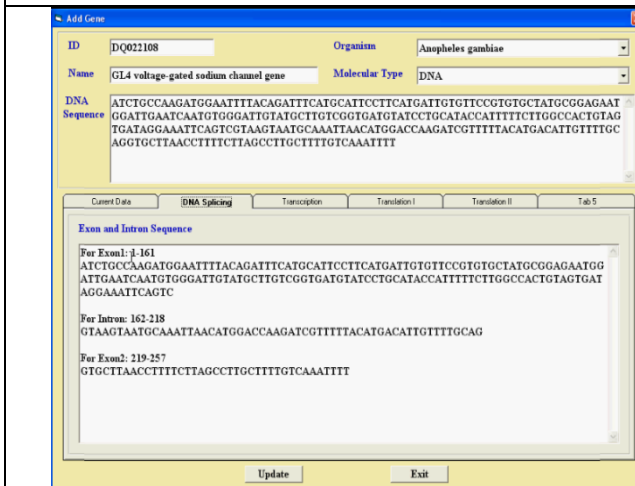

Fig. 3. A screen shot of mRNA splicing: represents the exon/intron regions within each gene.

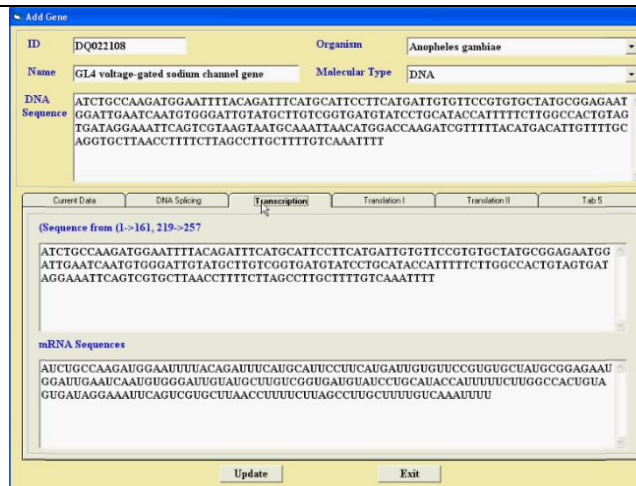
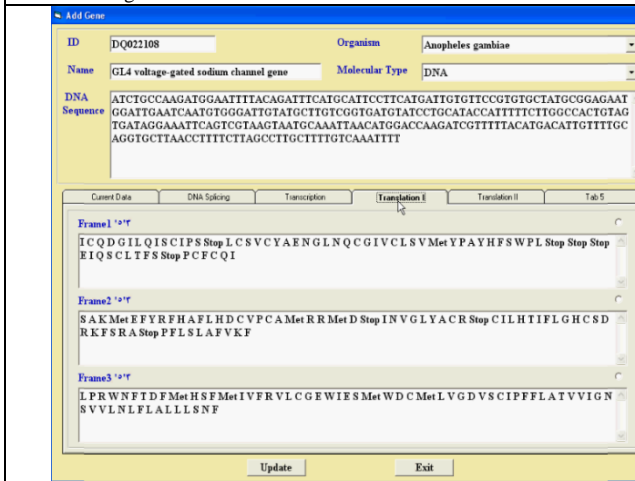
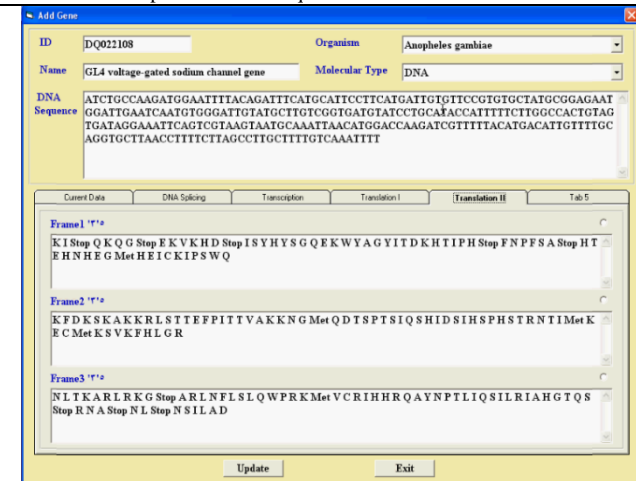

Fig. 4. A screen shot of transcription, the gene sequence is transcribed to obtain the mature spliced mRNA sequence.



(a)



(b)

Fig. 5. A screen shot of translation, the mRNA sequence is then translated into 6 frames and only one frame, the open reading frame (ORF) will be translated into a contiguous amino acid chain of a protein or a polypeptide.

#### D. Determination of the intron splice junctions:

We were able to define the intron splice sites using the GU-AG rule as shown above. No strictly followed rules appear to govern the distribution of these introns though they are generally less common in simpler eukaryotes. Introns are a very common feature in the genes of higher eukaryotes such as vertebrates and at least one intron exists in a gene. Aside from the sequences required for splicing, the length and nucleotide sequences of introns appear to be highly variable. In contrast, the position of introns within any given gene does seem to be evolutionarily-conserved, i.e., they are often in identical positions in alignments of the sequences of homologous genes.

All intron 5'-splice and 3'-splice junctions appear to be functionally equivalent to the splicing apparatus or spliceosome. In normal circumstances, splicing occurs only between the junctions of the same intron (cis-splicing). The molecular basis for differentiating between splice junctions of the same and different introns appears to be more complex and remains an important question for molecular biologists [14]. The majority of eukaryotic genes appear to be processed into a single type of spliced mRNA (monocistronic). However, some genes give rise to more than one type of mRNA sequence (policistronic) due to alternative splicing. In one extreme example of alternative splicing, one single human gene has been shown to generate up to 64 different mRNAs from the same primary transcript.

The nuclear membrane of eukaryotic cells provides a physical barrier that separates the process of transcription and translation in a way that never occurs in prokaryotes; where translation by ribosomes typically begins as soon as an RNA polymerase enzyme has begun to make an RNA copy of a gene coding region.

After the completion of the human genome project, a huge amount of DNA sequence information has been generated. The dealing with this large amount of data requires a clear need to gather, filter and evaluate this mass of information so that it can be used with greater efficiency. Bioinformatics is the science that has emerged in response to the development of genomics so it could handle, manage and analyze large data sets in short time with high speed and accuracy. Due to its importance, teaching bioinformatics at the undergraduate level in a biology laboratory program using customized, interactive and problem-based approaches has become an essential requirement in life and biomedical science curricula in the last two decades [5], [15], [16], [17], [18], [19], [20]. They all established guidelines for the contents and format of undergraduate bioinformatics courses and training programmes using customized software and tools with hyperlinks to web applications. These approaches will help increase cooperation between scientists of various departments, such as biology, mathematics and computer science, to conduct a given course. This first-level training will form the basis for advanced postgraduate and degree programs [13].

Due to the importance of incorporating bioinformatics within introductory undergraduate biology courses (curricula), many strategies have evolved. One of the applied strategies is the use of customized tools and databases to facilitate teaching,

time saving and preventing students from being overwhelmed by complex graphical user interface and outputs of international publicly available bioinformatics databases such as NCBI, ExPASy, nps@, etc. [19]. The complexity of web applications could be distracting and discouraging to many beginner students to learn bioinformatics; as they might feel "lost in cyber space" and loose insight of the main purpose of using a given tool. Further, the delay in obtaining results due to busy servers could cause frustration of both students and tutors and lose confidence in the exercise [19]. Additionally, using computers as essential tools in scientific education and research will strengthen the skills of graduates in using computers to access databases, manipulate and store specific information and communicate effectively. All these skills are essential requirements for modern graduates who are seeking good career opportunities [18].

There is a continuous and enormous development in the fields of bioinformatics and genomics and the fields employing them in the academia and business sectors. In the time being and in the future, there will be an increasing demand for graduates with good skills in bioinformatics and genomics.

For future plans and with the success of this EntomDB prototype, we will test the possibility of publishing a version with Arabic interface, which will significantly increase the base of users and attract more audience. Gene sequences of larger size will be tested with adding more functions and queries. This will further train and test the rigor of the system to handle larger body of input data and perform more complex functions. The entire genome sequence of the other selected insect models will be tested and more data and functions will be added to the system and the efficiency of access and retrieval of specific data will be tested. Hyperlinks with global tools and databases will also be inserted in the EntomDB for advanced users. The system will be tested for the possibility of off-line usage and a prototype CD of the system will be developed.

In conclusion, development of a local customized entomological database for research and education will increase the ability of undergraduate students and young scientists to master broad and sophisticated bioinformatics tools and apply them for better understanding of biological processes and systems. This database is an easy-to-use, self-learning tool to prepare the users for more specialized data analysis. Increasing the use of *in silico* "dry laboratory" bioinformatics of genome sequences will help obtain preliminary results to guide "wet laboratory" experiments, thus minimizing the time and costs.

#### REFERENCES

- [1] D. W. Mount (2001). Bioinformatics: Sequence and genome analysis, Cold Spring Harbor Laboratory Press, New York.
- [2] C. Ouzounis (2002). Biology by other means. Editorial, Bioinformatics, 18(12),1551-1552.
- [3] A. Valencia (2002). Bioinformatics and the theoretical foundation of molecular biology. Editorial, Bioinformatics, 18(13),377-378.
- [4] A. Campbell, L. Heyer (2003). Discovering genomics, proteomics and bioinformatics. Pearson Education, Benjamin Cummings, San Francisco, pp. 352.
- [5] Y. Ai, Jermiin, N. Firth (2003). Teaching bioinformatics: A student-centered and problem based approach. In: CAL-laborate, a collaborative publication on the use of Information Technology in tertiary teaching and learning for the life sciences, published by UniServe Science, The

- University of Sydney, Australia, <http://science.uniserve.edu.au/>, June, 2003, pp. 25-30.
- [6] H. A. Lim (2005). Informatics, Bioinformatics and Bioinformatics, a plenary lecture at the International Meeting on Frontiers of Physics, the Year of Physics, IMFP2005-Bioinformatics, pp.:1-18, <http://www.dtrends.com/Bioinformatics/bioinfoIMFP05.html>.
- [7] J. C. Venter, M. D. Adams, E. W. Myers, P. W. Li, R. J. Mural, G. G. Sutton, et al. (2001). The sequence of the human genome. *Science*, 291(5507), 1304-51.
- [8] E. S. Lander, L. M. Linton, B. Birren, C. Nusbaum, M. C. Zody, J. Baldwin, et al. (2001). Initial sequencing and analysis of the human genome. *Nature*, 409(6822), 860-921.
- [9] E. W. Sayers, T. Barret, D. Benson, E. Bolton, et al., (2010). Database resources of the National Center for Biotechnology Information, *Nucleic Acids Research*, Vol. 38, (Database issue), D5-D16.
- [10] M. Galperin (2006). The molecular biology database collection: 2007 update. *Nucleic Acids Research*, 35, (Database issue), D3-D4.
- [11] D. Benson, I. Karsch-Mizrachi, D.J. Lipman, J. Ostell, D. J. Wheeler (2007). Genbank. *Nucleic Acids Research*, 35 (Database issue), D3-D4.
- [12] J. A. Fox, S. McMillan, B. F. Francis Ouellette (2007). Conducting research on the web: 2007 update for the bioinformatics links directory. *Nucleic Acids Research*, 35 (Web Server issue), W3-W5.
- [13] C. Hack, G. Kendall (2005). Bioinformatics: Current practice and future challenges for life sciences education. *Biochem. Mol. Biol. Edu*, 33(2), 82-85.
- [14] D. E. Krane, M. L. Raymer (2005). *Fundamental concepts of bioinformatics*, Pearson Education, Benjamin Cummings, San Francisco, pp. 249-276.
- [15] J. Tillotson (2002). Strategies for introducing computer technologies into a biology laboratory program, *Biochem. Mol. Biol. Edu.*, 30(4), 232-234.
- [16] N. B. Centeno, J. Villa-freixa, B. Oliva (2003). Teaching structural bioinformatics at the undergraduate level, *Biochem. Mol. Biol. Edu*, 31(6), 386-391.
- [17] J. Cohen (2003). Guidelines for establishing undergraduate bioinformatics courses. *Journal of Science Education and Technology*, 12(4), 449-456.
- [18] J. Boyle (2004). Bioinformatics in undergraduate education, *Biochem. Mol. Biol. Edu*, 32 (4), 236- 238.
- [19] M. Neumann, N. Provar (2006). Using customized tools and databases for teaching bioinformatics in introductory biology courses. *Assoc. Biol. Lab. Edu. ( ABLE)*, 27, 321-328.
- [20] S. Cattle, J. Arthur (2007). BioManager: the use of a bioinformatics web application as a teaching tool in undergraduate bioinformatics training, *Briefings in Bioinformatics*, 8(6), 457-465.

# Evaluating the Impact of Critical Factors in Agile Continuous Delivery Process: A System Dynamics Approach

Olumide Akerele

School of Computing and Creative Technologies  
Leeds Metropolitan University  
Leeds, UK

Muthu Ramachandran, Mark Dixon

School of Computing and Creative Technologies  
Leeds Metropolitan University  
Leeds, UK

**Abstract**—Continuous Delivery is aimed at the frequent delivery of good quality software in a speedy, reliable and efficient fashion – with strong emphasis on automation and team collaboration. However, even with this new paradigm, repeatability of project outcome is still not guaranteed: project performance varies due to the various interacting and inter-related factors in the Continuous Delivery 'system'. This paper presents results from the investigation of various factors, in particular agile practices, on the quality of the developed software in the Continuous Delivery process. Results show that customer involvement and the cognitive ability of the QA have the most significant individual effects on the quality of software in continuous delivery.

**Keywords**—Agile software development; Continuous Delivery; Delivery Pipeline; System Dynamics

## I. INTRODUCTION

The Agile Manifesto places a high importance on the need for the frequent delivery of working software: "Our highest priority is to satisfy the customer through early and continuous delivery of valuable software" [1]. This subtle principle indicates that not all developed software is actually made available to the customer for use where it actually adds value to the customer's business. As Humble et al points out:

*"It's hard enough for software developers to write code that works on their machine. But even when that's done, there's a long journey from there to software that's producing value - since software only produces value when it's in production"* [2].

Software delivery is inhibited by a number of post-development issues: Configuration management problems, insufficient testing in production-like environment and poor collaboration among the various 'silos' in software projects are the major problems that cause software rejection at this Stage [2]. A practical example of such problem is the lateness by the operations team to realize they can't support a version of developed software due to the incompatibility of the software architecture with their available infrastructure. This is strictly owed to the lack of involvement and collaboration of the operations team in the development process, thus, resulting in delivery failure. Such post-development problems are the motivation for the *Continuous Delivery* (CD) initiative [2][4][10].

Tests automation, strong team collaboration, effective configuration management, deployment automation and good team culture [2][10] are the major practices advocated in CD to boost the effectiveness of a frequent delivery process . However, these factors are not a surety to a smooth CD process; while there have been overwhelming testimonies of success with these practices ,most notably by Flickr and IMVU – with up to 50 deployments a day [4], there have also been numerous instances of failures [2][19]. This shouldn't be surprising: project outcomes in software projects is faced by many limiting factors [5][6].

Various interacting and interconnected factors are present in software projects and these are accountable for the inconsistencies in the quality of software project results [7]. According to Brooks:

*"no one thing seems to cause the difficulty (in software projects)...but the accumulation of simultaneous and interacting factors... "* [7].

The primary goal of this work is to investigate the dynamic causal relationships of the variables within the CD 'system' and develop a *System Dynamics* (SD) [8] model to evaluate the impact of these pertinent factors on the quality of software projects adopting CD. This can be used as a tool to evaluate various managerial decisions and introduce reliability, predictability and risk aversion in the CD process. Vensim [9], free SD software is used for this research work.

### A. Problem

Continuous integration, tests automation, good culture and strong collaboration have been identified as the "pre-requisites" for a successful CD process [2][3][4][10][19]. However, software projects are daunted with several interrelated problems which make the project outcomes unreliable [5][6] – even with the adoption of the aforementioned "CD success pre-requisites" [2]. The success of software delivery is impacted by a host of non-exhaustive factors that interact in a continuous manner – creating revolving loops within software projects [5].

Refactoring of an automated acceptance test suite, as an example, is hypothesized to have a causal and dynamic effect on CD process: As the acceptance test automation script increases linearly with the project progress, the test suite complexity, brittleness, as well as coupling increases –

gradually introducing *test smell* into the automated acceptance test suite [11]. This is worsened by the presence of *schedule pressure*; developers take short cuts by ignoring the test coding standards and ideals in order to meet up with the estimated work [6]. The *test smell* effect has a negative ripple effect on the maintenance effort of writing automated acceptance tests [10]. However, after refactoring the test suite, there is a significant reduction in the test suite maintenance effort due to the improved design of the test scripts [2][10]. Refactoring, of course, comes at a cost of extra effort [12].

Such causal effects of various practices are the determinants of the failure and success of CD and there is a wide gap in academic research within this context [18]. Without the managerial proactiveness of the effects of various practices at various times in software projects, software delivery will continue to be uncontrollable, leading to many unpleasant surprises. A rigorous study of these variables, their dynamic effects and their impact on the quality of the developed software is vital to ensure repeatability and predictability of an efficient CD process.

### B. Literature Review

CD is a relatively new paradigm; this explains the reason for the paucity of research work done in this field. At the time of writing this paper, there isn't any research work categorically done on CD. However, some works have been done within considerably similar context: Kajko-Mattson [12] developed a preliminary process model incorporating the two parts of release management: the vendor and user side. Lahtela et al [3] presented the challenges in the delivery of software by performing a full case study. The authors identified 7 different challenges encountered in the release of software. Van Der Hoek et al [13] identified the problems of releasing software from a component-based software engineering approach. The authors developed a tool to solve the identified problems. Krishnan [14] developed an economic model to optimize the delivery cycle of delivering good quality software. These works adopt a big-bang traditional waterfall approach to delivery and not a repetitive delivery process – as is the case in an agile development. This casts a major doubt on the relevance of their findings to agile software projects. More so, these works are empirical based and not simulation based which indicates to a high degree that there is limitation on the control over the identified factors. Though these works give an

insight into some of the problems with delivering software, these problems are wholly generic and highly aggregated.

Abdel-Ahmed [5] was the first researcher to leverage SD in software process simulations. He investigated the effect of various management policies on development cycle time, quality and effort were presented. However, his work was based on the waterfall methodology approach which confines the applicability of the results to waterfall projects. The actual delivery process in software projects is also beyond the scope of his work. Melis et al [16] developed a SD model to investigate the impact of Test Driven Development (TDD) and Paired Programming (PP) on the cycle time, effort and quality of software projects. Cao [21] investigated the dynamics of agile software development and the impact of agile practices on cycle time and customer satisfaction using SD. With credit to the impact of the work done by these authors in agile software development, their works do not consider any post-development activities relevant to software delivery. Furthermore, there is complete exemption of the impact of schedule pressure experienced by software project teams.

The authors of the paper assert that the successful conclusion of this research work is going to be a pioneering development in the field of CD and will create further insights in which new research interests can evolve.

## II. RESEARCH SCOPE

This research aims to develop a SD model that delivery practitioners can adopt to have control over the delivery risk factors, particularly cost overrun and schedule flaws. Achieving this aim involves full investigation to determine the pertinent factors impacting the outcome of the CD practices described in section 1; the causal effects of agile practices on these advocated CD practices within the *delivery pipeline* [17] are also considered.

Fig.1 below presents an overview of the generic flow process of CD. The entire process line is known as the *delivery pipeline, deployment pipeline or build pipeline* [17]. The complexity of the pipeline created by teams will vary depending on the level of available resources, project risks involved and criticality of the developed software [35]. This research work is based on a standard 4-stage deployment pipeline as represented in Fig. 1.

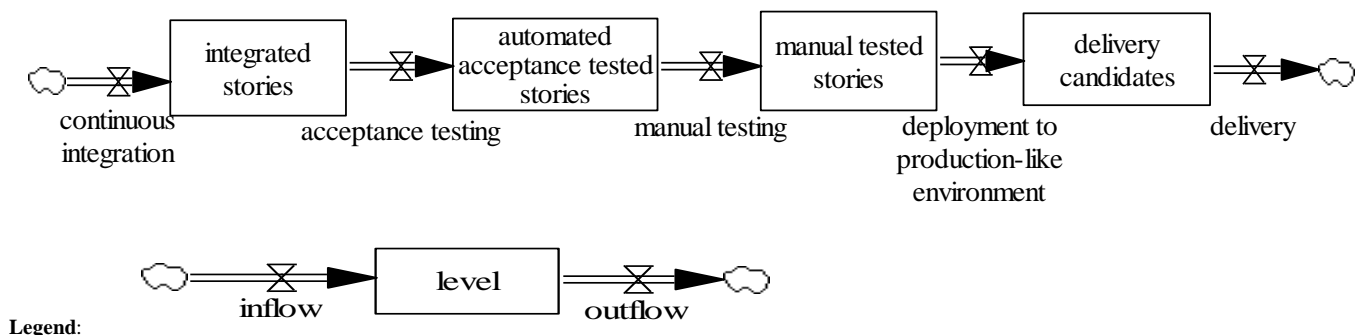

**Level:** Entity that builds or diminishes over a specified period of time; **Inflow/Outflow:** Rate of change in level

Fig. 1. Generic SD Continuous Delivery Flow Process

Mathematically, the legend above is exemplified by:

$$level(t) = level(t-dt) + inflow * (dt) \quad (1)$$

Fig.1 above shows each activity and their corresponding artifacts. The success of each initial stage is a criteria for the commencement of the succeeding stage. Our work lies in this pipeline to determine the relevant factors affecting the efficiency of this 'journey' for frequent software delivery.

#### A. Research Goal

The goal of this work is to develop a SD model to act as a tool for the delivery pipeline to ensure a repetitive, predictable and risk-free CD activity for software projects. The model will ensure a fully controllable delivery environment and help management anticipate the results of their deliberate actions.

#### B. Research Questions

This research work is aimed at answering the following major Research Questions (RQ):

**RQ1:** What are the key factors (environmental, human and technological) in software projects that impacting the success of CD? What are the agile practices that have an impact on the quality of software projects in the CD process?

**RQ2:** What are the dynamic and causal effects of each of these factors on the software quality in CD?

**RQ3:** What is the impact of the agile practices such as on-site customer, TDD, PP and Pair Testing on software quality in CD? What is the impact of the ability of the Quality Assurance (QA) tester on the quality of the software

#### C. Research Benefits

A number of benefits would be achievable from the success of this research work: Firstly, it will help to maintain a total control of the available resources to achieve a stable, repeatable and predictable CD process. The lack of such tool has created a huge gap in the industry and made delivery stability a difficult task. The stability that is realizable with this tool will help organizations striving to achieve CMMI levels 4 and 5 [22] accreditation.

This model may also be used as a risk management tool of the delivery process. Since the impact of potential technological and strategic decisions on outcomes such as project completion dates and number of deliverable features is possible via simulations, potential risks can be anticipated and proactively planned against or avoided completely. Several software organizations depend mainly on SD models as their major risk management tools [5].

This model will act as an invaluable tool to project managers, release managers and senior management of software development organizations interested in the frequent release of their software to customers.

In addition, the model can serve as a process improvement tool by helping to determine points for optimization of important variables like acceptance rate, build time, required effort, and etcetera.

### III. METHODOLOGY

This section describes how the objectives of the research work are planned to be achieved.

#### A. Data Sources

- Interview: Primarily, semi-structured interviews will be conducted with experienced agile consultants, project managers and developers to elicit the major active variables to achieve the objectives of this research work. A formal approach will be adopted to narrow down these factors to the most relevant active factors.
- Questionnaire/Survey: This will be developed and sent to practitioners within the CD field who will give their responses based on the valuable experience in the area. The responses will then be analyzed systematically.
- Literature review: Keywords such as "continuous delivery (modeling)", "release management (simulation)" and "software system dynamics" will be used to search for related work in digital libraries. Significant findings from related work will not only help in identifying some factors but also help in the quantification of the impact the factors have on other variables in the project. The quantification of this impact will be vital in the calibration of the SD model for simulations.
- Author's discretionary assumption: Where necessary, author's assumptions are used in the development of the model. Such assumptions will be sanctioned and perhaps, moderated by experienced agile practitioners via interviews and questionnaire.

#### B. Simulation

Simulations provide the computerized prototype of an actual system run over a specified period of time. They are useful in software projects to improve project understanding and knowledge base of project stakeholders.

Simulations offer a more realistic and cost-effective approach to realizing the objectives of this work as opposed to the 'rigidity' offered by empirical methods. The flexibility provided by simulation techniques to alter the variables for system behavior analysis will be impractical to achieve if the conventional empirical methods are adopted [5][15].

SD, a continuous simulation technique, provides the full functionalities to achieve the goals and objectives of this research work, hence, its adoption for this work. SD facilitates the visualization of the complex inter-relationship between variables in a software project system and runs simulations to study how complex project systems behave over time [6]. A system dynamic model has a non-linear mathematical structure of first order differential equations expressed as:

$$y'(t) = f(y, m) \quad (2),$$

Where  $y$  represents vector of levels,  $f$  is a non-linear function and  $m$  is a set of parameters.





Results showed the tdd group passed roughly 18% more tests than the control group that adopted the waterfall approach. The results in the work are however may have been confounded by the effects of PP.

A more relevant experiment was carried out on by Yenduri [27]. A two 9-person groups of senior undergraduate students to evaluate the impact of tdd on software quality and productivity; one group used the test first approach and the other using the test-last approach. Results showed 55% improvement in the acceptance test pass rate of the tdd group. The task developed however was described as a "small" project which implies results could vary with larger projects. Also, the size of the subjects is relatively small.

A survey was conducted by the authors directed at experienced project managers and developers with over 5yrs experience in tdd usage to determine the impact of tdd on acceptance tests success. Analysis of the responses gave values ranging from 30% to 60% improvement, with the mean of approximately 54%. The authors assumed a modest value of 50% and this value was further supported by two interviewees. One of the interviewees (I1)said:

*"The high level of granularity of functionality testing during TDD, when done effectively, guarantees the behavioural requirement of the system is fulfilled, severely limiting the causes of failures during functional testing to environmental factors or inaccuracy in the requirement elicitation. Conveniently, we achieve 50% better success during acceptance testing than when we used to adopt the test-last approach... "*

Baring other factors, the authors make a bold assumption that a full adoption of TDD should guarantee 100% success of acceptance tests. Hence, we estimate the success rate of acceptance tests pass rate without TDD to be 67% so that a full adoption of TDD will yield 100% success in our model. The estimated acceptance pass rate of the test –last approach is represented by the *average non-TDD pass rate* in the model. This value is quite close to values of test-last adopters (75%) in Williams' work [25].

*The planned degree of tdd* in the model represents the planned level of tdd adoption in the development of the software features for the project. No literature exists on the average level of tdd adoption. However, the standard degree of unit test coverage in the industry ranges from 80-90%. [28].Some platform providers maintain a strict level of unit test coverage before allowing promotion of software unto their platform. Sales force, a leading PaaS provider, insists on minimum unit test coverage of 75% before allowing promotion of customer's software unto their staging environment [29]. In our project case study, the planned level of tdd adoption is 100% for the project i.e. all features were planned to be developed by tdd approach.

For ease of analysis, we assume that the test suite offers complete coverage; implying all behavioral defects in the system are detected during development when tdd is fully adopted. This follows a similar assumption made by Williams et al in the development of their economic model [30].

The actual degree of tdd adoption is affected by schedule pressure [6][23]. Developers tend to "cut corners" when the team is behind schedule to try and catch up . When a team is behind schedule, the procedural steps f adopting tdd are easily bypassed to increase development speed. The *actual degree of tdd* is the effective percentage of features developed using the tdd approach in the project throughout the project. There is no published work on the estimated impact of schedule pressure on the degree of tdd adoption prompting the authors to derive simplistic mathematical model to estimate the impact of schedule pressure on the planned degree of tdd adoption. Effective and simple mathematical models can be developed by researchers when reliable data is not available for model parameterization. Forrester advised:

*"A mathematical model should be based on the best information that is readily available, but the design of a model should not be postponed until all pertinent parameters have been accurately measured. That day will never come. Values should be estimated where necessary.... "* [31]

As the schedule pressure develops, the team responds to falling behind in schedule by working extra hours and cutting their slack time to try and meet up with the lost work [32]. This makes the initial effect of SP very minute, hence, the initial flatness in the curve. However, as the pressure mounts, the "threshold" is exceeded and the team responds by cutting corners and reducing their adoption of TDD steps, instead, following the test last approach. It then gets to a maximum point where a increase in SP doesn't have an effect anymore. This forms the tail end/flat end of the other extreme end of the graph. This relationship is built in the variable *lookup of SP for tdd*.

*tdd factor*, the variable representing the impact of tdd on the estimated pass rate of the automated acceptance tests has the formula :  $average\ non\ TDD\ pass\ rate + (actual\ degree\ of\ tdd * tdd\ impact * average\ non\ TDD\ pass\ rate)$

where  $actual\ degree\ of\ TDD = IF\ THEN\ ELSE(Time=11, 0, planned\ degree\ of\ tdd * lookup\ of\ SP\ for\ tdd(schedule\ pressure)), TDD\ impact = 0.5\ and\ average\ non\ TDD\ pass\ rate=0.67.$

## V. MODEL VALIDATON

The model is validated in two folds, following the approach described by Richardson et el [20]: structural phase and behavioral phase. *Structural validation* is the examination of the structure of the entire model. This involves the studying of the inter-relationship and parameterization of the variables to ensure they are credible enough to produce replicate real-life scenarios. Experienced project managers, consultants and developers were sought for this process, with critical feedback used to rework the model in an iterative manner until the structure is approved by the reviewers. The model was also presented at two conferences and valuable feedback was incorporated to rework the model.

*Behavioural validation* aims to verify the model actually produces results that are similar to real-life project outputs. The model will be validated against data of output variables from a completed software project with similar characteristics

that successfully implemented CD. Coherence in the results between the simulation outputs and actual completed project outputs prove the model is capable of producing real-life project results, hence, validating the model. Also Success at this stage is a critical prerequisite before the model could be subjected to *sensitivity analysis* to answer the remaining research questions outlined.

A. Project Data

Data was sourced from a complete project that adopted CD and agile practices from a sales software vendor. The developed software is part of a comprehensive software suite used for enhancing sales of products by manufacturers.

The project case study used for this project was the software development project for their sales modeling solution. Data from the project is presented in the table 1.

Table 2 presents the data used to simulate the pressure experienced by the team. The pressure influences the adoption of major practices in the model and consequently the outcome of the project [5][6]. Fig. 5 below shows the simulated graphical representation of the SP experienced by the team. Schedule pressure is determined across each iteration in the project by the formula:

$$(Actual\ Work\ Left - Estimated\ Work\ Left) / Estimated\ Work\ Left \quad (3).$$

TABLE I. GENERAL PROJECT INFORMATION

Programming Language	Java
Project Duration	220 working days
Development Duration	203 working days
Iteration duration	2weeks
Team Size	5
Team Velocity	50
Agile Methodology Used	XP/Scrum
Number of Stories	199
Version Control System	Subversion
CI Server	Go
Configuration Management Tool	Chef
Unit Test Framework	JUnit
Automated Acceptance Testing Framework	BDD
Automated Acceptance Testing Tool	JBehave
Team Experience Mix	Average of 9years software projects experience
Working hours/day	7.5

TABLE II. PROJECT DATA USED FOR SCHEDULE PRESSURE SIMULATION

Iteration #	Estimated No of Tasks Committed	Actual No of Tasks Committed	Actual # User Stories Completed	Actual Value of Work Completed (Points)	Production Code Size (LOC)
1	30	20	6	62	450
2	40	28	7	55	695
3	40	46	11	60	1123
4	40	44	11	51	1095
5	40	41	10	49	960
6	40	43	10	58	1145
7	40	38	9	62	967
8	40	34	8	41	888
9	40	27	6	47	620
10	40	25	7	50	540
11	20	0	0	59	0
12	40	53	14	61	1322
13	40	55	13	65	1485
14	40	48	12	64	1055
15	40	46	11	60	912
16	40	41	10	58	993
17	40	46	12	66	1211
18	15.6	53	15	69	1368
19	0	56.96	17	63	1420
<b>Total</b>	<b>705.6</b>	<b>744.96</b>	<b>199</b>	<b>1099</b>	<b>18249</b>

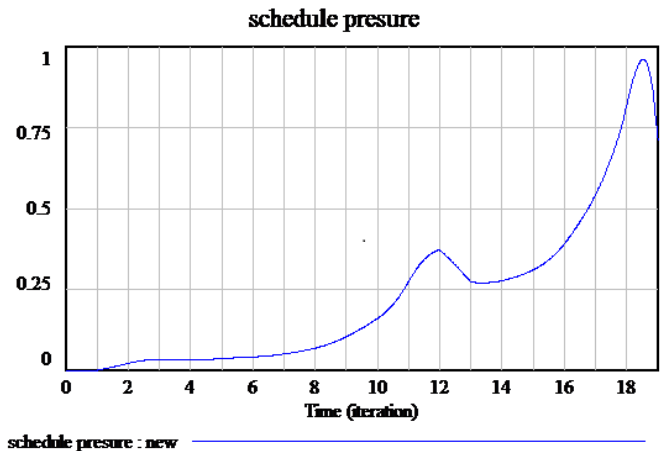

Fig. 3. Project Schedule Pressure

B. Simulation Results

The table below shows the extracted results from the simulation model. "AA" denotes "automated acceptance" in table 3.

TABLE III. RESULTS COMPARISON OF ACTUAL PROJECT OUTCOME AND SIMULATED PROJECT OUTCOME

Iteration	Actual # of Passing AA test cases	Actual AA Pass Rate	Simulated # of Passing AA Test Cases	Simulated AA Pass Rate	Actual # Passing UA test cases	Actual UA Test pass rate	Simulated # passing UA test cases	Simulated UAT pass rate
1	31	83.78	33.83	91.44	23	74.19	21.37	68.94
2	40	80	44.30	88.61	26	68.4	26.58	69.96
3	62	89.85	60.14	87.17	36	75	34.51	71.90
4	55	82.08	59.77	89.22	39	82.9	34.95	74.39
5	58	90.62	56.75	88.68	40	81.63	37.58	76.70
6	63	90	62.84	89.78	50	87.71	45.15	79.22
7	57	95	52.29	87.15	41	75.92	43.99	81.47
8	44	83.01	46.71	88.14	48	87.27	45.77	83.23
9	33	84.61	34.54	88.57	39	81.25	40.46	84.31
10	42	91.30	39.50	85.89	40	90.9	36.93	83.95
11	0	0	0	56.20	0	0	0	68.34
12	46	63.01	53.51	73.31	35	59.32	39.38	66.76
13	56	80	52.24	74.6	38	71.69	37.97	71.64
14	47	75.80	46.48	74.98	41	68.33	43.43	73.33
15	38	69.09	39.67	72.13	37	75.51	34.51	70.44
16	43	79.62	38.64	71.56	42	76.36	37.73	68.60
17	36	70.58	35.64	69.89	31	63.26	33.19	67.75
18	50	76.92	46.58	71.66	35	64.81	36.69	67.95
19	49	69.01	51.85	73.04	51	82.25	42.25	68.15

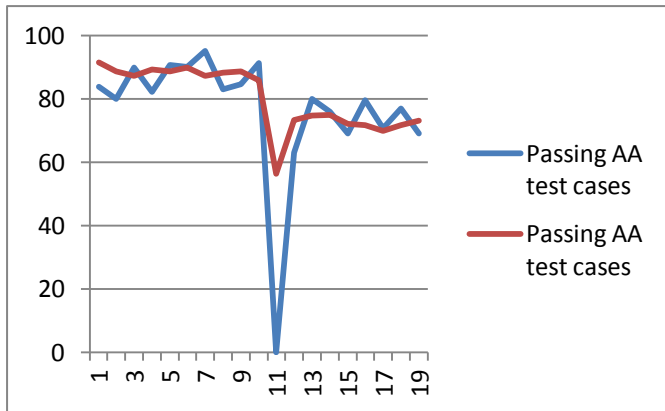

Fig. 4. Graphical Comparison of Actual and Simulated Automated Acceptance test (AAT) Pass Rate

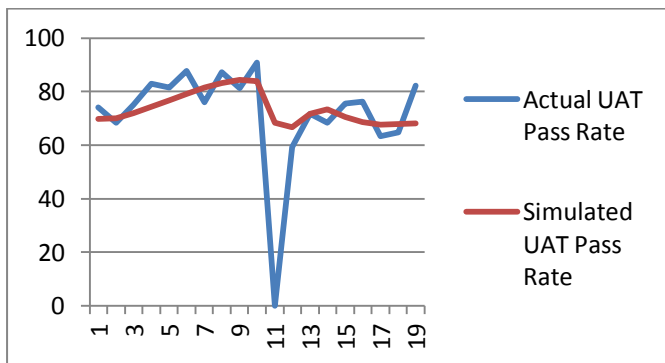

Fig. 5. Graphical Comparison of Actual and Simulated User Acceptance Test Pass Rate

The data provided in table 3 is used to examine the validity of the model by comparing the actual project outcome with the outcome produced by the developed simulation model. The actual automated acceptance test pass rate and simulated automated acceptance test pass rate represents the actual number of passing automated acceptance and user acceptance test cases expressed as a percentage of the total number of automated acceptance and user acceptance test cases and simulated number of passing automated acceptance and user acceptance test cases expressed as a percentage of the total number of automated acceptance and user acceptance test cases respectively.

Noticeably, the results from the model highly correlate with the actual project outcome. There were two main points of significant discrepancy in the values of the results for AAT results: The 1st, 2nd and 12th iteration. In the first and second iteration, the team recorded a low number of automated acceptance test cases due to the relatively few number of stories delivered which significantly reduced the total sample for that iteration. Hence, the high impact on the % variation between the simulated and actual results. It is plausible to believe that the actual pass ratios for these iterations with low test cases are exaggerated. In the 12th iteration, the team had significantly more actual failing tests due to the impact of major refactoring on the passing test suite which occurred in the 11th iteration. It has been reported that that software project teams generally experience problems of failing tests after major redesign due to the coupling among various components of the software [33]. The 11th iteration is not recognized as a non-productive iteration by the simulation

model as the actual project progress was inhibited due to the management decision to carry out major refactoring. This behaviour is not built into the simulation model as this is a manual decision made solely by the discretion of the team.

The major point of disparity in the simulated and actual pass rate in the UAT scenario is apparent in the 19th iteration. A possible argument for this is that testers tend to overlook many possible scenarios when a project is seemingly coming to closure and build assumptions into the system to get the project over with; in extreme cases, testers actually pass failing tests and are not really ready to find faults to avoid project extension and look forward celebrating project completion. This phenomenon was further attested by an interviewee (I2). This phenomenon may explain the considerable disparity in the passing test rates in the final iteration than that projected by the simulation model.

### C. Model Experimentation

Experiments are performed to carry out sensitivity analysis on the model to determine the impact of various policies on the quality of the developed software by altering the planned level of adoption of the major influencing agile practices. The major practices of interest are: PP, PT, customer involvement and TDD. The impact of the ability of the QA (cognitive ability and domain savvy) is also investigated. Schedule pressure plays a prominent role in the actual level of adoption of the practices. The project data used for the model validation is used and the level of adoption of each practice is altered. Table 4 below shows the various scenarios typifying various managerial policies regarding agile practices adoption.

TABLE IV. SCENARIOS FOR AAT MODEL SUB-SECTION

	PP	TDD	Customer involvement
Scenario 1	0%	0%	0%
Scenario 2	100%	0%	0%
Scenario 3	0%	100%	0%
Scenario 4	0%	0%	100%
Scenario 5	100%	100%	0%
Scenario 6	100%	0%	100%
Scenario 7	0%	100%	100%
Scenario 8	100%	100%	100%

TABLE V. SIMULATED AUTOMATED ACCEPTANCE TEST PASS RATE

Iteration #	Scenario #							
	1	2	3	4	5	6	7	8
1	22.7	25.9	34.1	56.9	38.9	64.9	85.3	97.4
2	2m1.9	25,3	32.9	54.9	37.9	63.2	82.3	94.8
3	21.6	24.9	32.3	54.0	37.3	62.4	80.8	93.4
4	22.1	25.5	33.2	55.4	38.1	63.7	83.0	95.4
5	22.0	25.3	32.9	55.0	37.9	63.4	82.4	94.9
6	22.3	25.6	33.4	55.8	38.3	64.1	83.6	95.9
7	21.6	24.9	32.4	54.1	37.3	62.3	81.0	93.2
8	21.9	25.2	32.8	54.9	37.6	63.0	82.0	94.1
9	22.1	25.3	33.0	55.3	37.8	63.3	82.5	94.5
10	21.8	24.7	32.1	54.6	36.5	61.9	80.4	91.2
11	21.4	23.5	21.4	53.6	23.5	58.7	53.6	58.7
12	22.3	22.5	29.2	55.8	29.4	25.2	73.0	73.5
13	21.7	22.4	29.3	54.2	30.3	56.0	73.3	75.8
14	21.7	22.5	29.4	54.3	30.5	56.2	73.6	76.3
15	21.4	21.8	28.5	53.6	29.1	54.7	71.3	72.8
16	21.8	21.9	28.5	54.6	28.7	54.9	71.3	71.7
17	21.5	21.5	27.9	53.7	27.9	53.7	69.8	69.8
18	22.0	22.0	28.6	55.1	28.6	55.1	71.6	71.6
19	22.4	22.4	29.2	56.1	29.2	56.1	73.0	73
Average	21.9	23.84	30.5	54.8	30.4	59.67	76.5	83.6

AAT pass multiplier

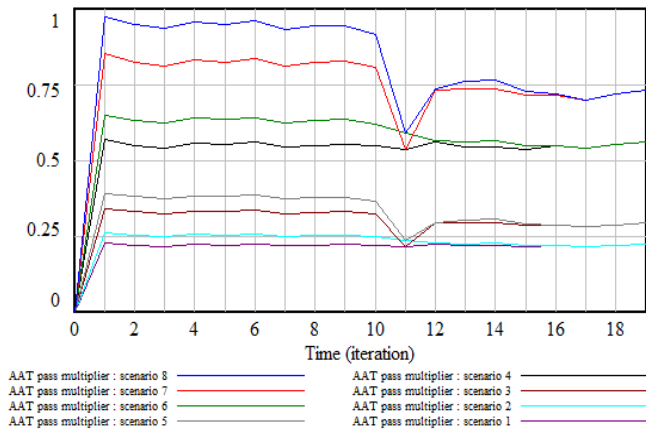

Fig. 6. Graph for Automated Acceptance Test Rate for Various Scenarios

Table 5 and Fig. 6 show the relative impact of applying various managerial policies on the quality of the software with the values rounded off to the nearest 1 decimal point. Table 1 above shows the impact of various management policies on the AAT pass rates. Clearly, scenario 8 (adoption of all practices) provides the most outstanding results until iteration 5 when it levels up with scenario 7 (TDD and customer involvement).

While scenario 4's performance (customer involvement) is not the best, it provides the most stable pass ratios all through the project irrespective of the schedule pressure. Unsurprisingly, scenario 1 had the poorest results having not adopting any of the practices.

TABLE VI. SCENARIOS FOR UAT MODEL SUB-SECTION

	PT	QA Cognitive Ability	QA Domain Knowledge
Scenario 1	0%	low	low
Scenario 2	100%	low	low
Scenario 3	0%	high	low
Scenario 4	0%	low	high
Scenario 5	100%	high	low
Scenario 6	100%	low	high
Scenario 7	0%	high	high
Scenario 8	100%	high	high

TABLE VII. SIMULATED UAT PASS RATE

Iteration #	Scenario #							
	1	2	3	4	5	6	7	8
1	50.6	57.0	58.3	53.9	68.3	61.9	61.5	69.5
2	51.3	57.8	59.1	54.7	69.3	62.7	62.4	70.5
3	52.7	59.2	60.6	56.1	71	64.3	64	72.5
4	54.5	61.3	62.7	58	73.5	66.5	66.2	75
5	56.2	63.2	64.7	59.8	75.8	68.6	68.3	77.3
6	58.1	65.2	66.8	61.8	78.2	70.8	70.5	79.9
7	59.7	67.1	68.6	63.5	80.4	72.8	72.5	82.1
8	61	68.5	70.1	64.9	82	74.3	74	83.9
9	61.7	69.2	70.9	65.6	82.8	75	74.8	85
10	61.6	68.4	70.3	65.3	81.2	73.9	74	85.3
11	59.4	59.4	66.7	62.5	66.7	62.5	69.9	69.9
12	56.6	58.9	61.7	58.8	65.3	61.6	63.9	68.1
13	58.8	61.9	64.9	61.4	69.9	65.3	67.5	73.3
14	59.3	62.5	65.5	61.9	70.6	66	68.1	74.1
15	58.8	61.5	64.4	61.2	68.8	64.6	66.9	72
16	58.2	60.5	63.5	60.5	67.1	63.4	65.7	70
17	58	60.1	63	60	67.1	63.4	65.7	70
18	58.2	60.3	63.2	60.3	66.6	63	65.4	69.2
19	58.4	60.5	63.4	60.5	66.8	63.2	65.6	69.5
Average	57.5	62.23	64.65	60.5	72.1	66.5	67.7	74.5

UAT pass multiplier

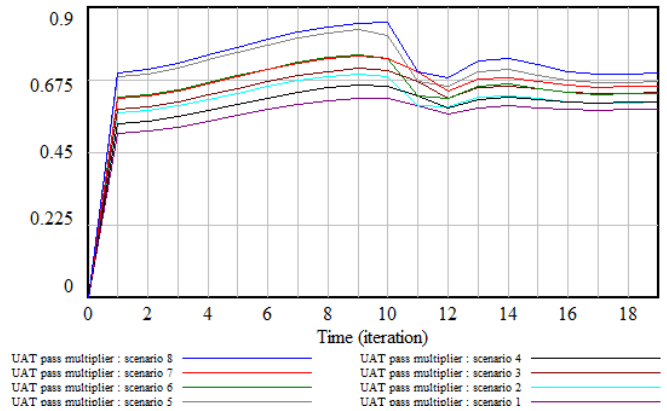

Fig. 7. Graph for User Acceptance Testing Rate for Various Scenarios

Table 6 shows the various scenarios of factors affecting the quality of user acceptance testing. The results for the *UAT pass multiplier* with various scenarios are presented in table 7 and Fig.7. Various PT adoption policies were simulated as well as determining the impact of management hiring options of the pertinent to the ability of the QA tester. These factors help improve the sad path test coverage and discover defects that are only usually discoverable by the system end user [34][36]. PT in the context of this paper is the practice of developers pairing with the QA alone or with the QA and onsite customer in writing and coding the test cases to run behavioral examples of system features authored by the customer[34].

As such, PT is not considered to have significant impact on the AAT pass ratio since the test examples written by the customers are unequivocally defined and does not necessarily need the exploratory testing skill input of a second tester/developer. The impact of SP is clearly seen to reduce the pass ratio in some scenarios while it remains relatively inactive in some scenarios. The cognitive ability of the QA is noticeable to be most significant on the UAT pass rate in the project followed closely by PT. The adoption of PT and having a QA with high cognitive ability with commendable domain savviness yield 17% improvement in the UAT pass rate to a project with poor QA Ability without a pair tester. However, it remains to be known if the savings made by deploying a second tester and hiring a QA with immense domain savvy and cognitive ability are more than the cost of their introduction

#### D. Limitation of the Study

The calibration of the model was based on data from peer-reviewed literature, surveys and interviews. Bias of any of the sources could inhibit the validity of the model.

Furthermore, the sample size of the actual test cases per iteration produced by the team is relatively small. This being middle sized project, it may imply that this model is only applicable to middle-large sized projects with numerous test case developed due to high number of features; the model may yield different results for small projects.

Most importantly, these effectiveness of the various factors are valid under the conditions experienced by the project team, most notable the schedule pressure experienced. Intuitively, without the effects of schedule pressure process improvement practices, the adoption of these factors will yield better results.

## VI. CONCLUSIONS AND FUTURE WORK

This paper reports a developed SD model that acts as a decision making and process improvement pool to software development teams practicing CD. The goal of the model is to improve the effectiveness of the CD process and help managers optimize their development process. The impacts of practices such as PP, TDD, PT, customer involvement on the quality of the software were investigated. The authors also investigated the impact of the QA ability on the quality of software. The impact on SP experienced by teams is also substantiated in this study. Validating the model against data from a completed middle sized project, customer involvement proves to have the most significant impact on the quality of

onsite AAT while the cognitive ability of the QA has the most impact on the quality of UAT.

The authors are addressing the limitations of this work and currently working on evaluating this model in an uninfluenced and "ideal" environment by simulating an exploratory project case study to fully evaluate the impact of various managerial policies on the CD process.

Furthermore, it is not enough to determine the qualitative impact of these various factors on the quality of the software project. This work points attention for possible concerns to address questions like: "what are the trade-offs of these practices and the optimal level of adoption of these practices on the CD performance metrics?"; what is the economic effectiveness of the adoption of the agile practices on the CD process?"; what is the extra resource requirement necessary to adopt these practices?"; "is the extra cost necessary to incorporate these practices better devoted to other value-adding tasks such as development or QA?"; "do the benefits(quality improvement) of the adoption of these practices outweigh their associated costs?"

#### REFERENCES

- [1] Beck, Kent; et al. (2001). *Manifesto for Agile Software Development*. Agile Alliance. Retrieved 14 Jan 2012.
- [2] Humble, J. and Farley, D. *Continuous Delivery: Reliable Software Releases Through Build, Test, and Deployment Automation*. Addison Wesley, 2010.
- [3] Lahtela.A and Jantti.M, *Challenges and problems in release management process: A case study*, in 2011 IEEE 2nd International Conference on Software Engineering and Service Science (ICSESS), 2011, pp. 10 –13.
- [4] Fitz, T. *Continuous Deployment at IMVU: Doing the impossible fifty times a day*.2009. Published on 2<sup>nd</sup> October, 2009, Date accessed 2<sup>nd</sup> Jan, 2013. <http://timothyfitz.com/2009/02/10/continuous-deployment-at-imvu-doing-the-impossible-fifty-times-a-day/>
- [5] Abdel-Hamid, T. and Madnick, S. *Software Project Dynamics: An Integrated Approach*. Prentice Hall, 1991.
- [6] Madachy, R.J. *Software Process Dynamics*. Wiley-IEEE Press, 2008.
- [7] Brooks, Jr., F.P. *The Mythical Man Month and Other Essays on Software Engineering*. Addison Wesley, 1995.
- [8] Ogata, K. *System Dynamics*. Prentice Hall, 2003.
- [9] Ventana Systems Inc, 2012, <http://vensim.com/>
- [10] Gruver, G., Young, M., and Fulghum, P. *A Practical Approach to Large-Scale Agile Development: How HP Transformed LaserJet FutureSmart Firmware*. Addison Wesley, 2012.
- [11] Borg, R. and Kropp, M. *Automated Acceptance Test refactoring*. Proceedings of the 4th Workshop on Refactoring Tools, ACM (2011), 15–21.
- [12] M. Kajko-Mattsson and F. Yulong, *Outlining a Model of A Release Management Process*, J. Integr. Des. Process Sci., vol. 9, no. 4, pp. 13–25, Oct. 2005.
- [13] A. van der Hoek and A. L. Wolf, *Software release management for component-based software*, Softw. Pract. Exper., vol. 33, no. 1, pp. 77–98, Jan. 2003.
- [14] M. S. Krishnan, *Software release management: a business perspective*, in Proceedings of the 1994 conference of the Centre for Advanced Studies on Collaborative research, 1994, p. 36.
- [15] Madachy, R.J. *System dynamics modeling of an inspection-based process*, Proceedings of the 18th International Conference on Software Engineering, 1996, (1996), 376 –386.
- [16] Melis, M., Turnu, I., Cau, A., and Concas, G. *Evaluating the impact of test-first programming and pair programming through software process simulation*. Software Process: Improvement and Practice 11, 4 (2006), 345–360.

- [17] Humble, J., Read, C., and North, D. *The deployment production line*. Agile Conference, 2006, (2006), 6 pp. –118.
- [18] Mantle, M.W. and Lichty, R. *Managing the Unmanageable: Rules, Tools, and Insights for Managing Software People and Teams*. Addison-Wesley Professional, 2012.
- [19] L. Klosterboer, *Implementing ITIL Change and Release Management*, 1st ed. IBM Press, 2008
- [20] G. P. R. and A. L. P. III, *Introduction to System Dynamics Modeling*. Pegasus Communications, 1981.
- [21] Cao, L., Ramesh, B., and Abdel-Hamid, T., *Modeling dynamics in agile software development*. ACM Trans. Manage. Inf. Syst. 1, 1 (2010), 5:1–5:26.
- [22] Inst, C.M.U.S.E. *The Capability Maturity Model: Guidelines for Improving the Software Process*. Addison Wesley, 1995
- [23] K. Beck, *Test-driven development: by example*. Boston: Addison-Wesley, 2003.
- [24] Y. Rafique and V. B. Mistic, “The Effects of Test-Driven Development on External Quality and Productivity: A Meta-Analysis,” *IEEE Transactions on Software Engineering*, vol. 39, no. 6, pp. 835–856, Jun. 2013.
- [25] B. George, “An initial investigation of test driven development in industry,” in *ACM Symposium on Applied Computing*, 2003, pp. 1135–1139.
- [26] R. C. Martin, *Agile software development: principles, patterns, and practices*. Upper Saddle River, N.J.: Prentice Hall, 2003.
- [27] S. Yenduri and L. Perkins, “Impact of Using Test-Driven Development: A Case Study,” *Software Eng. Research and Practice*, pp. 126-129, 2006.]
- [28] Cornett, S., "Code Coverage Analysis," Bullseye Testing Technology <http://www.bullseye.com/coverage.html> , accessed 20th February 2014.
- [29] Salesforce, *Force.com Apex Code Developer's Guide*, <http://www.salesforce.com/us/developer/docs/apexcode/>, date accessed 10th January 2013]
- [30] L. W. H. Erdogmus, “The Economics of Software Development by Pair Programmers.”
- [31] Forrester, J.W, *Industrial Dynamics*. Cambridge, MA: The M.I.T.Press,1961
- [32] B. W. Boehm, *Software engineering economics*. Englewood Cliffs, N.J.: Prentice-Hall, 1981.
- [33] [M. Fowler and K. Beck, *Refactoring: improving the design of existing code*. Boston: Addison-Wesley, 2012.
- [34] J. Russell and R. Cohn, *Pair Testing*. Book on Demand, 2012.
- [35] O. Akerele, M. Ramachandran, and M. Dixon, “System Dynamics Modeling of Agile Continuous Delivery Process,” 2013, pp. 60–63.
- [36] O. Akerele, M. Ramachandran, and M. Dixon, “Testing in the Cloud: Strategies, Risks and Benefits,” in *Software Engineering Frameworks for the Cloud Computing Paradigm*, Z. Mahmood and S. Saeed, Eds. Springer London, 2013, pp. 165–185.



# Extending Access Management to maintain audit logs in cloud computing

Ajay Prasad

University of Petroleum and Energy Studies  
Dehradun, India

Prasun Chakrabarti

Sir PadampatSinghania University  
Udaipur, India

**Abstract**—considering the most often talked about security risks in cloud computing, like, security and compliance, viability, lack of transparency, reliability and performance issues. Bringing strong auditability in cloud services can reduce these risks to a great extent. Also, auditing, both internally and externally is generally required and sometimes unavoidable looking into the present day competition in the business arena. Auditing in web based and cloud based usage environments focuses mainly on cost of a service which determines the overall expenditure of the user organization. However, the expenditure can be controlled by a collaborative approach between the provider company and the user organization by constantly monitoring the end user access and usage of subscribed cloud services. Though, many cloud providers will claim of having a robust auditable feature, the generic verifiability with sustainable long term recording of usage logs do not exist at all. Certain access management models can be perfectly extended to maintain audit logs for long terms. However, maintaining long term logs certainly has storage implications, especially with larger organizations. The storage implications need to be studied.

**Keywords**— Cloud Computing; Access Management; Audit logs

## I. INTRODUCTION

In most of the business audits the primary focus is on the bills of several activities that the employees or management incurs while performing their tasks. For example, the employee CTC and the formulations of overtime duties are considered while auditing. It goes even further as part of auditors to ascertain whether the employees' CTC and other costs are at par with their roles and tasks done for the company. The auditors also ensure that the facilities, equipment etc. provided to the employees are properly utilized and are not used for vested purposes as well as in malpractices. In similar fashion, on incorporating cloud computing, major tasks of an organization will shift onto cloud computing. Thus, the usage pattern of the cloud services by the employees will affect the overall billing of the cloud services to a great extent. Not only that, Gartner [1] emphasizes the difficulty of auditing for security. The major difficulty would be of tedious procedures and arrangements that needs to be made by the service providers to address an auditing demand. Looking at this, the service providers would be quite reluctant (though not openly) to support the auditing demands in totality. Gartner [1] suggests to have an internal audits done by professional services or IT consulting firms for cloud usage. The issue is not that simple though. The parameters of audit of usage and security should not be through a one sided records keeping. Hence, "audit yourself" as suggested by Gartner [1] may be very less

comprehensive and may not address all the aspects of usage of cloud. When the organizations will start relying more and more on cloud services, the aspects of cost will come into play more and more. Apart from all these, the fact of mal-practices and threats are also an issue which needs a constant monitoring of usage of services by the employees of the organizations.

### A. Audit of usage

Major parts of the audit of usage involves:

- a) Duration of usage Vs task assigned to the employees.
- b) Services used Vs task assigned to the employees.
- c) Uploads and downloads to and fro from cloud Vs

Compliance.

The services used by the employee is related to the roles assigned to him her. The roles are managed by the management which can be formulated through the policies of the management. The overall policies and roles are/can be managed by an almost automated access management coordinating with the cloud provider. Financial audits, operational audits and compliance audits as in [2] are also necessary and applicable on cloud usage. The [2] also describes the roles of internal and external auditors in general businesses. The [3] emphasizes the importance of auditing at scheduled intervals mutually agreed between providers and users based on mutual agreements. While putting on important points of risks in cloud computing [4] puts forth 2 points namely, investigative support and long term viability of usage in clouds. Both these points are more or less related to long term audit ability in cloud scenarios.

## II. AUDITABILITY AND ACCESS MANAGEMENT

Currently many methodologies of access controls are used namely Discretionary Access Control (DAC) [5] where the access is granted based on discretion of the user of the resource; the Mandatory Access Control (MAC) [6] is mostly designed to grant access only through the mandatory system enforcement policies and not that of users. However, MAC doesn't discriminate over the various types of resources available to the user once he complies the mandatory entry requirements. This can lead into authorization issues. The Identity based Access Control (IBAC) [7] grants access through access control lists (ACL) [8], which is a list based on the users' identity. The Role based Access Control (RBAC) [9] provides access to a resource based on the user's role in the organization or system. The Lattice Based Access Control (LBAC) [10] maintains an ordered set of security labels combined with a set of categories. Authors of [11] notes that

the effectiveness of all above access mechanisms are not sufficient for maintaining fine grained access control policies in today's collaborative environments including clouds. [11] goes further to propose Attribute Based Access Control model (ABAC). The model consists of two aspects i) a policy model and ii) an architectural model. The policy in policy model is applied to the web service access control through architectural model. The ABAC model can be used to have a structured log maintained for audit purposes and having fine grained policy frameworks. The aspect of maintaining long term logs can be realized without losing too much space.

Policies → access → policy based audit logs

A typical scenario of maintaining ABAC based audit logs is shown in figure 1.

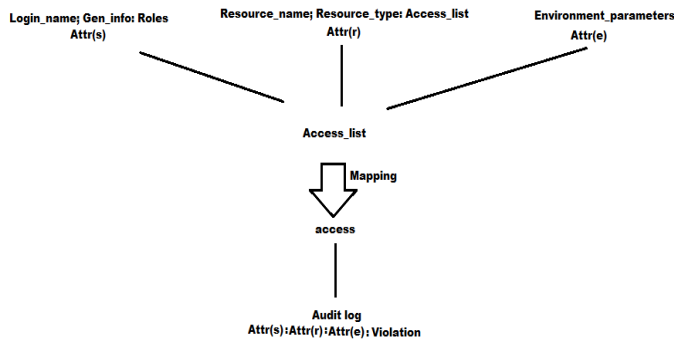

Fig. 1. Attribute Based Access Control

Thus, audit logs for each request can be maintained in a structured and precise fashion. Also, we can have automated analytics for the auditors using the ABAC audit logs. The audit log can be formalized based on the ABAC model as follows:

$Attr(e); Attr(s); Attr(r); Access(s, r, e); Matched\_Violation$

The time stamp is assumed to be integral part of access. Matched violation, is the factor or measure of violation (if any) that has occurred due the access. For example, in most of the cases the user tries to access the resource off time or during the time the resource is under secret editing. Although, the access may not be granted to the resource but, the move by an employee to access it is in fact a violation. The measurement of violation factor can be established by the one to one mapping of all possible violations with number sequences with attached weight age.

$$Violation\_Set = \{ V_1, V_2, V_3, \dots, V_n \}$$

$$Offence\_weightage = \{ W_1, W_2, W_3, \dots, W_n \}$$

Table I shows an example set of violation types and corresponding offence weight age based on the seriousness of the violation.

TABLE I. EXAMPLE RESOURCE VIOLATIONS

Violation	Offence Weightage
Accessing Resource/service not ready (offline access confidential resource)	0.3
Login Failure on R	0.01
Resource/service not ready (non-confidential)	0.1
Accessing Resource/service not allowed	0.2
Editing Resource/service finalized (edit offline)	0.8

We propose another access model i.e. Bitwise Attribute Based Access Control (BABAC), where, the methodology of maintaining fine grained policies and roles is in bitwise fashion. Also, the mapping of policies and roles onto access is bitwise, which is more compact form than the ABAC model. This can lead to save more space in log maintenance. The user roles are maintained as states and the mapping is just done by 'AND'ing the resulting policies and obtaining the access to a set of fine grained services/resources. The figure 2 depicts the access in BABAC model of mapping.

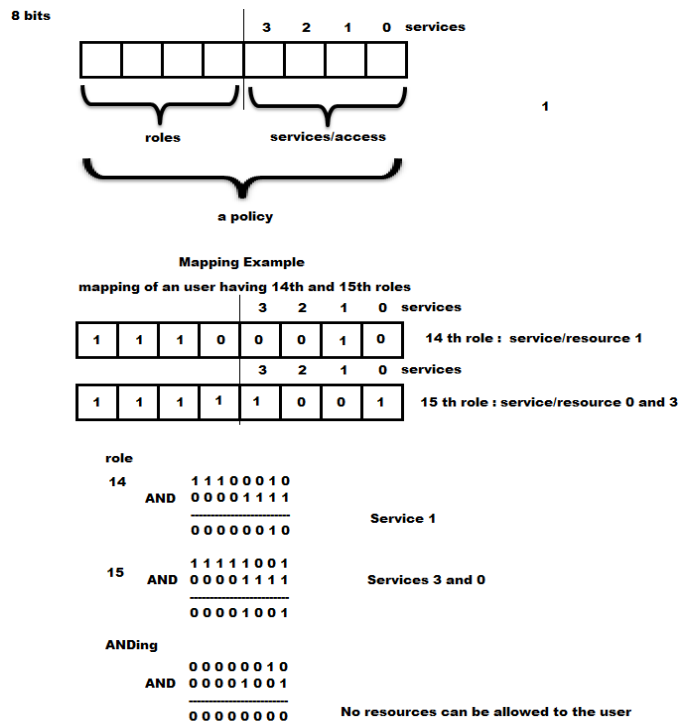

Fig. 2. Mapping in BABAC

The process of mapping is simple, however, maintaining these kind of policies can be little complex, however, one can make automated system consoles which can form these Bitwise policies with very less effort as in case of ABAC. In case of ABAC the Granularity and scaling can be done resource-wise whereas, in case of BABAC the scaling is restricted to an allowable bit size. In fact, methods can be devised to come out of these constraints as well. The audit log can be formalized based on the BABAC model as follows:

*States\_word(s, r, e); Access\_word(s, r, e); Matched\_Violation*

### III. SIMULATION AND RESULTS

A simulation in cloud environment was made to study the storage requirements of various methods discussed above. The simulation was carried out for 3 aspects of (long term) log maintenance while monitoring:

- a) Generic monitoring.
- b) Generic monitoring with ABAC logs;
- c) Generic monitoring with BABAC logs;

Cloudsim tool [12] was used to simulate for the above factors. The simulation was made for 10 to 20 users with subjects and resources scaling from 10 each to 20 each. Although this might not be a real scenario but its more than enough to get good ideas about the storage implications of the long term log keeping for auditing purposes.

To understand the study of the logs we have to go along the three most important parts of the ABAC logs and BABAC logs, namely:

- a) Subject Pattern
- b) Resource Pattern
- c) Environment Pattern

#### A. In case of ABAC:

Typically, subject pattern involves login name, general information and state/role. The criteria for the state/role can be in a range (from no role to all roles). An organization can have as large as 50 roles on a particular application. Studies can't be made on all aspects of role. However, a typical 10-20 role subject pattern is studied in our simulation. That is, a user might not have any roles as well as at the same time a user can have 20 roles. The subject pattern is shown in figure 3a.

Resource pattern can depend upon number of atomically usable resources leased in cloud by the organization. It can be a database, it can be a file, it can be an application. It can be parts of application; it can be an OS or other platforms. Every resource can have access lists (typically ranging from 10-20) is classified by resource type, name and access list. Access list can be the set of roles that are allowed access on a particular resource. Thus, a resource pattern can be as shown in figure 3b.

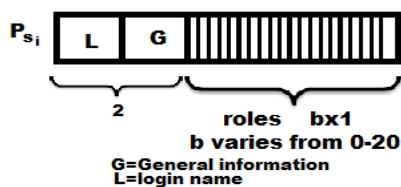

Fig. 3. a) Subject pattern (ABAC)

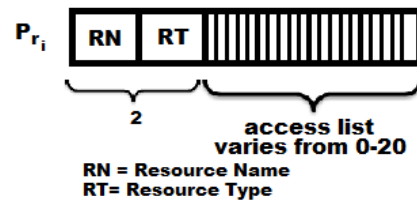

Fig. 3. b) Resource pattern (ABAC)

However, mostly the resource pattern will be owing to access list in the same manner as roles in subject pattern. The environment pattern can mostly contain time ranges. In some cases they can be holding specifics but, in our case we will be filling it as constant. Hence, the log space can be calculated as:

$$Log_i = P_{s_i} + P_{r_i} + P_e + S_v$$

Where,  $P_{s_i}$ = Size of subject pattern for ith log.  $P_{r_i}$ = Size of resource Pattern for ith log.  $P_e$ = Size of environment pattern (constant) and  $S_v$ = Size of violation information.

#### B. In case of BABAC:

In BABAC model the roles are made in bitwise fashion. Hence, scaling factors may arise. However, for 0-20 roles 4 bit is required which can be scaled to 128 roles on 8 bit. However, the user attributes remains the same.

The 128 roles bit can contain environmental constraints also. As shown in figure 4a) the login name and general information parts are same as in case of ABAC. However, the roles are now bitwise represented and given a space of 2 bytes (a word).

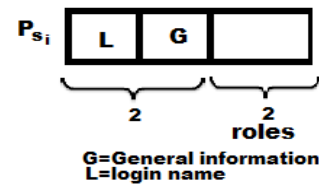

Fig. 4. a) State Pattern (BABAC)

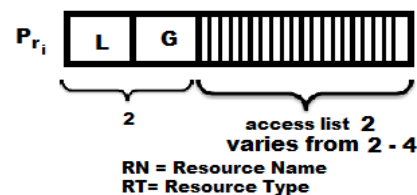

Fig. 4. b) Resource Pattern (BABAC)

The resource pattern will hold the resource name and resource type as in ABAC but the access list can be fixed to 16 bits (2 bytes) (see figure 4b).

However with 0-20 accesses will make us add 1 more word (after 16 accesses). In BABAC the environment pattern is part of the states in the subject pattern only. Thus, the overall log space can be calculated as:

$$Log_i = P_{s_i} + P_{r_i} + S_v$$

Where,  $P_{s_i}$ = Size of subject pattern.  $P_{r_i}$ = Size of resource Pattern for ith log.  $S_v$ = Size of violation information.

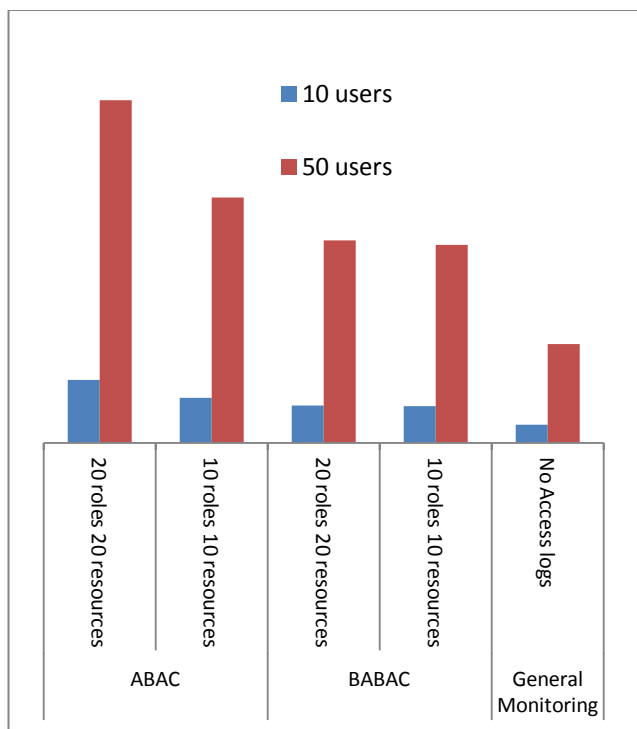

Fig. 5. Storage implications in various methodologies

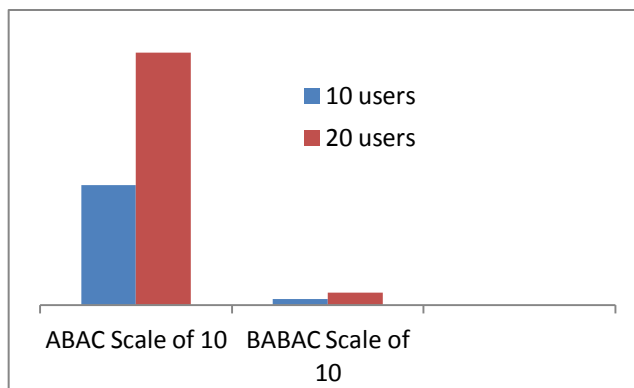

Fig. 6. Storage implications while scaling from 10-20 roles and resources

Various simulations were made to assess the storage implications, like, a) space required for 10-50 users in one year. b) change in space required if roles and access lists are scaled. The results were as expected. Considering the BABAC binary format its space requirements is much less than ABAC. However, ABAC is much simple to maintain in cases of huge number of roles and resources. As expected the storage requirements might be much more as revealing in figure 5, where the generic logs are requiring much lesser space than ABAC and CABAC logs. Figure 6 reveals the scaling factor, if

roles and access lists (resources) are added, then logs sizes will get affected, as well as number of logs will also increase resulting in space requirements. Scaling BABAC looks much more efficient than ABAC. The change in case of BABAC is almost negligible. However, the overall results show that in any case ABAC and BABAC both are suitable and can be used with some costs pertaining storage.

#### IV. CONCLUSION

The need for long term logs maintenance in cloud will facilitate both internal and external auditing. A more formal approach would be to extend the access management to provide long term log maintenance, say, for years. These logs can then be made readable through automated systems to the auditors for assessments. Among the various access management systems, the ABAC was found more suitable to the needs of long term log keeping. However, our proposed model BABAC (based on the principles of ABAC) can be more efficient in terms of space. Thus, overall long term monitoring can utilize ABAC or BABAC to facilitate the auditable cloud computing environments.

#### REFERENCES

- [1] Daryl Plummer, "The Business Landscape of Cloud Computing," Gartner, at <http://www.ft.com/cms/5e231aca-a42b-11e1-a701-00144feabdc0.pdf>, retrieved Dec 20, 2013.
- [2] Rick Hayes Roger Dassen Arnold Schilder Philip Wallage, "PRINCIPLES OF AUDITING- An Introduction to International Standards on Auditing" Prentice Hall FT, second edition, 2005
- [3] Guiding Principles on Cloud Computing in Law Enforcement, IACP, Jan 31 2013.
- [4] Cloud Computing in Law Enforcement: Survey Results and Guiding Principles, <http://www.policechiefmagazine.org/magazine/index.cfm>, retrieved 20 Jan 2014.
- [5] National Computer Security Center (NCSC), "Glossary of Computer Security Terms" (NCSC-TG-004), October 21, 1988, <http://csrc.nist.gov/secpubs/rainbow/tg004.txt>
- [6] D.E. Bell and L.J. LaPadula, "Secure Computer Systems: Mathematical Foundations and Model", Mitre Corp. Report No. M74-244, Bedford, MA, 1975
- [7] Identity-based Access Control, Technical Brief, ProCurve Networking by HP, [www.moonblinkwifi.com](http://www.moonblinkwifi.com), retrieved 16 Feb 2014
- [8] Internet Security Glossary, Version 2 RFC 4949 <http://datatracker.ietf.org/doc/rfc4949/>, retrieved Feb 2014.
- [9] Ravi S. Sandhu et al., "Role-Based Access Control Models", IEEE Computer, February 1996, pp. 38-47
- [10] Ravi S. Sandhu, "Lattice-Based Access Control Models", IEEE Computer, November 1993, pp. 9-19
- [11] E Yuan, and J Tong. "Attribute Based Access Control (ABAC) for Web Services", In proceedings of the IEEE Conference on Web Services (ICWS'05), Orlando Florida, USA. July 2005
- [12] Calheiros, R. N., Ranjan, R., Beloglazov, A., De Rose, C. A. F. and Buyya, R., CloudSim: a toolkit for modeling and simulation of cloud computing environments and evaluation of resource provisioning algorithms. Software: Practice and Experience, 41: 23 – 50. doi: 10.1002/spe.995 2011.

# LPA Beamformer for Tracking Nonstationary Accelerated Near-Field Sources

Amira S. Ashour

Dept of Electronics & Electrical Communications Eng.,  
Faculty of Engineering, Tanta Univ., Egypt. Dept of Computer Science,  
Computer & IT College, Taif Univ., KSA.

**Abstract**—In this paper, a computationally very efficient algorithm for direction of arrival (DOA) as well as range parameter estimation is proposed for near-field narrowband nonstationary accelerated moving sources. The proposed algorithm based on the local polynomial approximation (LPA) beamformer, which proves its efficiency with far-field applications. The LPA estimates the instantaneous values of the direction of arrival, angular velocity, acceleration as well as the range parameters of near-field sources using weighted least squares approach which based on Taylor series. The performance efficiency of the LPA beamformer to estimate the DOAs of near-field sources is evaluated and compared with the Recursive Expectation-Maximization (REM) method. The comparison is done using standard deviation of DOA estimation error as well as for range versus signal to noise ratio (SNR). The simulation results show that LPA beamformer outperform REM1 in signal-to-noise ratio requirements.

**Keywords**—Near-field; range and DOA estimation, moving source tracking; LPA beamformer; REM (Recursive Expectation Maximization)

## I. INTRODUCTION

Direction-of-arrival (DOA) estimation for source localization has been widely applied in the field of radar, sonar, seismology, oceanography and communication. Various algorithms [1], [2] were proposed to deal with the problem of DOA estimation for far-field scenarios. While, near fields are important because they are operationally complex and structurally rich. Away from the antenna, in the far zone, things become predictable; the fields take simple form, and approach plane waves. There is not much to know about the behavior of the antenna aside from the radiation pattern. However, when the sources are located close to the array (i.e. near-field), the wave front emitted from these sources become spherical instead of planar at each sensor position. Therefore, the far-field estimation algorithms are no longer be applicable as the inherent curvature of the waveforms should be taken into account. Therefore, advanced localization algorithms for estimating DOA and range have been derived for near-field stationary source localization, including the modified MUSIC [3], weighted linear prediction (LP) [4], and second-order statistics (SOS) [5, 6]. On the contrary, for localizing a near-field moving sources of constant velocity, a Stationary Passive Synthetic Aperture Array method was used [7]. Also, the Maximum Likelihood (ML) approach was efficient in case of little sample numbers, but required high computational cost [8]. Therefore, several techniques as Recursive Expectation

Maximization (REM) was studied to reduce the ML complexity. The EM prevents the computational complexity by switching the multidimensional search problem to less dimensional parallel search problems. In [9], the Expectation-maximization (EM) based recursive algorithm was applied with moving sources in the near-field.

Simultaneously, several applications require tracking of accelerated moving sources as the additional use of some kinematic parameters (i.e. acceleration, etc.) to improve the tracking performance and overcomes some of the problems of crossing targets. Consequently, [10, 11] have been proposed for the accelerated moving sources in the far-field using the LPA beamformer to localize accelerated moving sources. The LPA proved its perfect performance in different scenarios of fast moving accelerated sources and low SNR. As a result, in this paper the LPA beamformer algorithm is proposed to the scenario of near-field accelerated sources situation. It estimates the time-varying parameters (DOA, angular velocity, acceleration and range) of a near-field moving accelerated sources. The performance of the LPA beamformer is compared with that of the REM1 method using different signal to noise ratios (SNR).

This paper is organized as follows. The problem and data model are formulated in Section II. In Section III, introduce the near-field accelerated sources' parameter estimation algorithm based on the LPA algorithm. In Section IV, the performance analysis and simulation results will presented. Finally, Section V concludes the paper.

## II. PROBLEM FORMULATION

Foremost, a description of the radiation zone concept and the time-varying near-field signal model is introduced before establishing the LPA beamformer approach for tracking accelerated time-varying DOA and range parameters of the near-field sources.

### A. Radiation Zone

Radiation zones are defined to simplify the complex mathematical equations for radiating sources. Generally, the radiation zones are divided into the far-field zone and near-field zone. The wavelength ( $\lambda$ ) emitted by the source defines the boundary of the two zones. If the distance of the signal emitted by the source to antenna array is large i.e.  $r \gg \lambda$ , then the far-field assumption is valid. In this case, the incoming waves towards the array are approximately planar. Moreover, if the signal emitted by the source is very close to an array, i.e.

$r \ll \lambda$ , then the source is in the near-field region. Therefore, in indoor environments the near-field representation is more suitable with spherical wave fronts than using far-field.

**B. Time-varying near-field signal model**

It is assumed that the source signals are collected by  $n = 2M + 1$  sensors with  $d$  distance between its adjacent antennas in a uniform linear array (ULA). As  $Q$  narrowband near-field signals from time-varying directions  $\theta(t) = [\theta_1(t), \dots, \theta_Q(t)]$ , arrive at the array, the vector  $r(t) = [r_1(t), \dots, r_Q(t)]$  will represent the unknown range parameters of the moving sources. Therefore, the parameter vector to be estimated is  $\Theta(t) = [\theta^T(t), r^T(t)]^T$ . Thus, the signal model for the data observed at the output of the sensors at time instant  $t$  is,

$$x(t) = \mathbf{A}(\Theta(t))\mathbf{s}(t) + \mathbf{e}(t) \tag{1}$$

The steering matrix which consists of  $Q$  steering vectors  $[\mathbf{a}(\Theta_i(t)), i = 1, \dots, Q]$  is,

$$\mathbf{A}(\Theta(t)) = [\mathbf{a}(\Theta_1(t)), \mathbf{a}(\Theta_2(t)), \dots, \mathbf{a}(\Theta_Q(t))] \tag{2}$$

The steering vector is a function of the unknown parameter vector,  $\Theta_i(t) = [\theta_i^T(t), r_i^T(t)]^T$ . Also,  $\mathbf{s}(t)$  is the vector of the received signals given by  $\mathbf{s}(t) = [\mathbf{s}_1(t), \dots, \mathbf{s}_Q(t)]$  and the noise vector is  $\mathbf{e}(t) = [\mathbf{e}_1(t), \mathbf{e}_2(t), \dots, \mathbf{e}_n(t)]$

Similar to [12], the output signal from the  $m^{th}$  element for a given snapshot  $t$  is given by

$$x_m(t) = \sum_{q=1}^Q e^{j\tau_{mq}} \mathbf{s}_q(t) + \mathbf{e}_m(t) \tag{3}$$

Where,  $\mathbf{s}_q(t)$  is the signal from the  $q^{th}$  incident source,  $\mathbf{e}_m(t)$  is the noise at the  $m^{th}$  element, and  $\tau_{mq}$  is the phase shift associated with a propagation time delay between the element at the center of the array and the sensor  $m$  of the  $q^{th}$  source. This phase shift is given by (4) as a function of the source signal parameters, angle of arrival  $\theta_q$ , range  $r_q$ , and the wavelength  $\lambda$ .

$$\tau_{mq} = \frac{2\pi}{\lambda} \left\{ \left( \sqrt{(r_q^2) + (md)^2} - 2r_q md \sin \theta_q \right) - r_q \right\} \tag{4}$$

The  $(2M+1) \times 1$  output vector can be written as (5), where the reference point is the element at the center of the array.

$$x(t) = \begin{bmatrix} x_{-M}(t) \\ \vdots \\ x_0(t) \\ \vdots \\ x_M(t) \end{bmatrix} = \mathbf{A}(\theta, r)\mathbf{s}(t) + \mathbf{e}(t) \tag{5}$$

Where,  $\mathbf{A}(\theta, r) = [\mathbf{a}(\theta_1, r_1), \mathbf{a}(\theta_2, r_2), \dots, \mathbf{a}(\theta_Q, r_Q)]$  is the  $(2M+1) \times Q$  matrix. As the corresponding array response vector  $\mathbf{a}(\theta_q, r_q)$  is given by

$$\mathbf{a}(\Theta) = \mathbf{a}(\theta_q, r_q) = \begin{bmatrix} e^{j\tau_{-Mq}} \\ \vdots \\ e^{j\tau_{-q}} \\ \vdots \\ e^{j\tau_{Mq}} \end{bmatrix} \tag{6}$$

Approximating  $\tau_{mq}$  using the second order Taylor expansion, yields to the following expression for the signal model in (3).

$$x_m(t) = \sum_{q=1}^Q e^{j(\xi_q m + \psi_q m^2)} \mathbf{s}_q(t) + \mathbf{e}_m(t) \tag{7}$$

The parameters  $\xi_q$  and  $\psi_q$  are functions of the DOA and the range; respectively, and can be expressed as

$$\xi_q = \left( \frac{-2\pi d}{\lambda} \sin \theta_q \right), \quad \psi_q = \left( \frac{\pi d^2}{\lambda r_q} \cos^2(\theta_q) \right) \tag{8}$$

Therefore, the problem addressed in this paper is the estimate of the DOA's and their parameters (angle, angular velocity and acceleration) as well as the range of incident sources given the observation array data  $x(t)$ . The LPA beamformer is used to determine the time-varying near-field DOA, range and their parameters under the following assumptions:

- 1) The source signals are uncorrelated
- 2) The additive noise is a zero-mean spatially white independent from the source signals
- 3) The distance  $d \leq \lambda_q, \lambda_q$  is the shortest wavelength of all signals

**III. LPA ALGORITHM FOR NEAR-FIELD SOURCES' PARAMETER ESTIMATION**

The LPA beamformer is developed as proposed for accelerated moving near-field sources tracking as its performance advantages with the accelerated moving sources introduced in [10]. It is assumed that the parameters of interest are described by a polynomial model shown in [13]. Using the weighted least squares approach to formulate the LPA beamformer for a single source assumption, which can be extended to the multiple source case. The following LPA based function will be minimized as in [10, 13] to be,

$$G(t, \Theta) = \frac{1}{\sum_k \omega_h(kT)} \sum_k \omega_h(kT) \|x(t+kT) - \mathbf{a}(\Theta, kT)s(t+kT)\|^2 \quad (9)$$

Where,  $\|\cdot\|$  stands for the norm. The summation interval in (9) is determined by the window function  $\omega_h(kT)$  which can be given by

$$\omega_h(kT) = \left(\frac{T}{h}\right) \omega\left(\frac{kT}{h}\right) \quad (10)$$

The scaling parameter  $h$  determines the window length, and  $\omega(v)$  is a real symmetric function [ $\omega(v) = \omega(-v)$ ] and satisfies the conventional properties,

$$\omega(v) \geq 0, \quad \omega(0) = \max_v \omega(v), \quad \int_{-\infty}^{\infty} \omega(v) dv = 1 \quad (11)$$

The source motion within the observation interval using Taylor series is,

$$\begin{aligned} \theta(t+kT) &= \theta(t) + \theta^{(1)}(t)(kT) + \frac{\theta^{(2)}(t)}{2}(kT)^2 + \frac{\theta^{(3)}(t)}{6}(kT)^3 + \dots \\ &= c_0 + c_1 kT + c_2 (kT)^2 + c_3 (kT)^3 + \dots \end{aligned} \quad (12)$$

Here,  $T$  is the sampling interval.

Assuming that the observation window is sufficiently short and, therefore, the fourth and later terms in (12) are negligible, therefore

$$\theta(t+kT) = c_0 + c_1 kT + c_2 (kT)^2 \quad (13)$$

Where,

$$c_0 = \theta(t), c_1 = \theta^{(1)}(t), c_2 = \frac{1}{2} \theta^{(2)}(t) \quad (14)$$

being the instantaneous source DOA, angular velocity, and acceleration, respectively. So, the problem is to estimate the vector  $\mathbf{c} = (c_0, c_1, c_2)^T$  for the nonstationary sources.

Similarly, the range model will be,

$$r(t+kT) = r_0 + r_1 kT + r_2 (kT)^2 \quad (15)$$

Both the DOAs and the ranges can be shown together in the vector,  $\Theta(t) = [\theta^T(t), r^T(t)]^T = [\Theta_1^T, \dots, \Theta_Q^T]^T$ , where  $\Theta_q = [c_{0q}, c_{1q}, c_{2q}, r_{0q}, r_{1q}, r_{2q}]^T$ . As  $\mathbf{a}(\Theta)$  depends on the time  $kT$  and the vectors  $\mathbf{c}$  and  $r$ .

Let us minimize (9) with respect to the unknown deterministic waveform  $s(t+kT)$  to get the following,

$$\frac{\partial G}{\partial s^*(t+kT)} = \frac{-\omega_h(kT)}{\sum_k \omega_h(kT)} \mathbf{a}^H(\Theta, kT) \{x(t+kT) - \mathbf{a}(\Theta, kT)s(t+kT)\} = 0 \quad (16)$$

The estimate of the waveform  $s(t+kT)$  is obtained as:

$$\hat{s}(t+kT) = \frac{\mathbf{a}^H(\Theta, kT)x(t+kT)}{n} \quad (17)$$

Recalling that the number of sensors is  $n = 2M + 1$ , the property  $\mathbf{a}^H(\Theta, kT)\mathbf{a}(\Theta, kT) = n$  is exploited. Inserting (17) into (9) to obtain  $G(t, \Theta)$  as,

$$G(t, \Theta) = \frac{1}{\sum_k \omega_h(kT)} \sum_k \omega_h(kT) \left\{ x^H(t+kT)x(t+kT) - \frac{|\mathbf{a}^H(\Theta, kT)x(t+kT)|^2}{n} \right\} \quad (18)$$

Then, minimize (18) over the vector parameter  $\Theta$  to obtain the DOA as well as the range parameters. This is equivalent to the maximization of

$$P(t, \Theta) = \frac{1}{n \sum_k \omega_h(kT)} \sum_k \omega_h(kT) |\mathbf{a}^H(\Theta, kT)x(t+kT)|^2 \quad (19)$$

where,  $|\cdot|$  stands for the absolute value and the function in (19) is known as the LPA beamformer function which includes the near-field accelerated moving source parameters. Here, the maximization of the LPA function requires search over  $c_0, c_1, c_2, r_0, r_1$  and  $r_2$ .

The steps of the proposed algorithm for near-field parameter estimation is straight forward from that in far-field accelerated sources [10], and can be summarized as follows:

Step1: take initial values of DOA  $c^0$  and range  $r^0$  parameters.

Step2: calculate the source motion within the observation interval using Taylor series for the DOAs and range by (13) and (15).

Step3: calculate the LPA beamformer function for DOAs and range in (19).

Step4: Update the parameters.

The same properties of the proposed LPA beamformer with far-field is still applicable in the near-field case, which are:

- The LPA beamformer is convenient for slowly as well as rapidly moving sources.
- The window width selection is important for accurate parameter estimation.
- Adding the acceleration term decreases the MSE.

#### IV. SIMULATION RESULTS

A half wavelength of the incoming signals is used for the spacing between the adjacent elements in the ULA. Uncorrelated near-field narrowband moving sources are assumed with array of  $n = 9$  sensors. Also, a rectangular window with  $N = 50$  snapshots is considered for the LPA beamformer. The following scenarios are used to clarify the LPA beamformer performance in the near-field accelerated moving sources and to compare it with that of REM1 in [9].

Case 1,2: (LPA output for single and double sources)



Figure 1 shows the LPA beamformer output for near-field single source case in pairs, where the time-varying DOA parameters are  $[\theta(k), \theta^{(1)}(k), \theta^{(2)}(k)] = [4^\circ, -1^\circ k, 1^\circ k^2]$ .

Similarly, Fig. 2 illustrates two sources scenario in pairs, where the time-varying DOA parameters of the two sources are  $[\theta_1(k), \theta_1^{(1)}(k), \theta_1^{(2)}(k)] = [4^\circ, -2^\circ k, -2^\circ k^2]$  &  $[\theta_2(k), \theta_2^{(1)}(k), \theta_2^{(2)}(k)] = [16^\circ, 2^\circ k, 2^\circ k^2]$ .

It is clear that, the LPA can identify correctly the source location, as the peak in each figure indicates the source location as shown in the figures pairs. The estimates of the DOAs have been obtained from the main maximum of the beamformer function (19). The source acceleration is considered as a factor to improve the source localization in nonstationary situations than using the angle and angular velocity only as in [13].

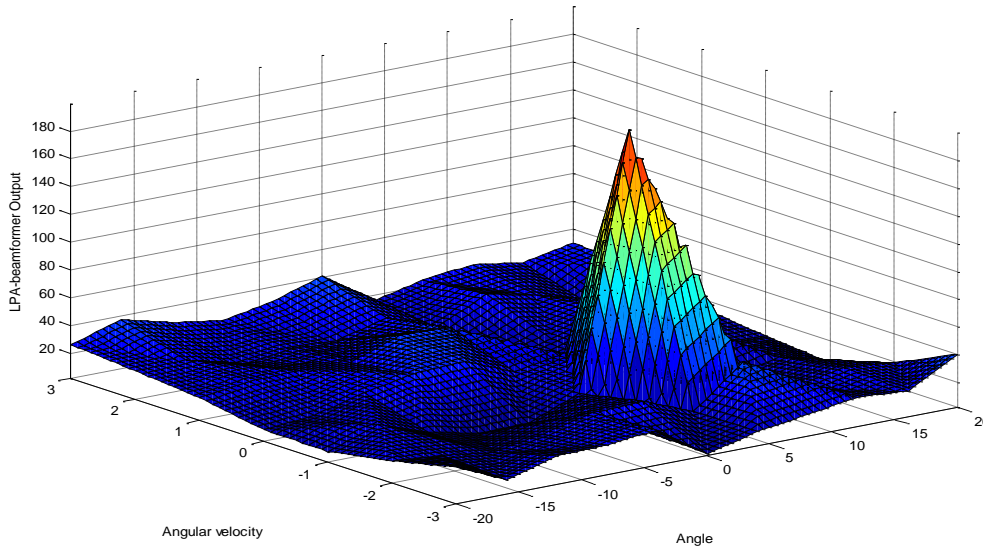

Fig. 1. (a): The output of the LPA beamformer for the single source case, at 5dB for  $(c_0, c_1)$  pair, where the source DOA parameters are:

$$[\theta(k), \theta^{(1)}(k), \theta^{(2)}(k)] = [4^\circ, -1^\circ k, 1^\circ k^2]$$

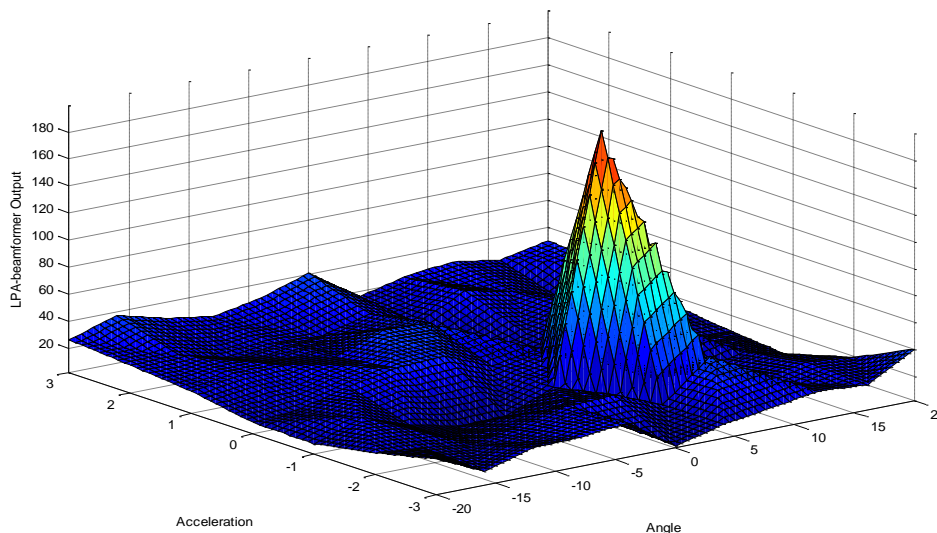

Fig. 1. (b): The output of the LPA beamformer for the single source case, at 5dB for  $(c_0, c_2)$  pair, where the source DOA parameters are:

$$[\theta(k), \theta^{(1)}(k), \theta^{(2)}(k)] = [4^\circ, -1^\circ k, 1^\circ k^2]$$

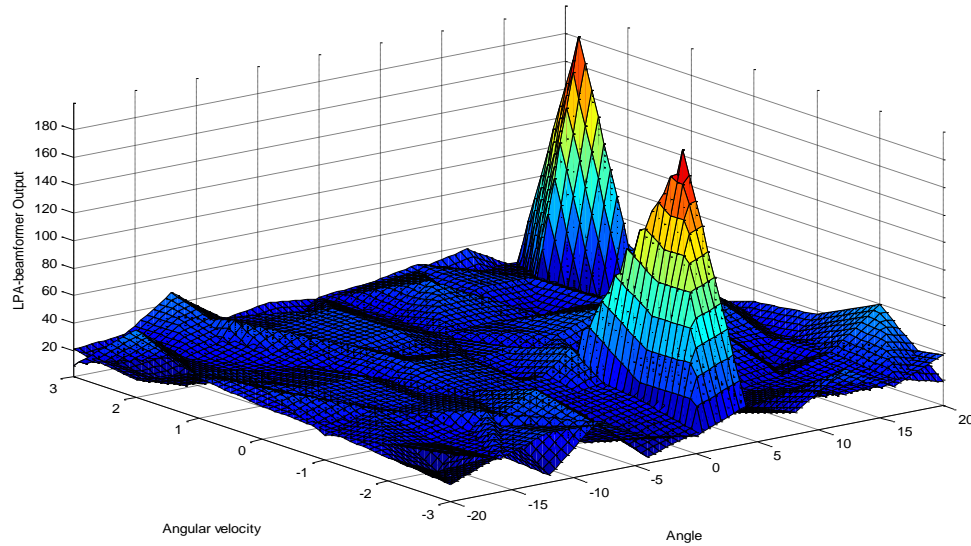

Fig. 2. (a): The output of the LPA beamformer for 2 sources senario, at 5dB for  $(c_0, c_1)$  pair. The DOA parameters of the two sources are:

$$[\theta_1(k), \theta_1^{(1)}(k), \theta_1^{(2)}(k)] = [4^\circ, -2^\circ k, -2^\circ k^2] \text{ and}$$

$$[\theta_2(k), \theta_2^{(1)}(k), \theta_2^{(2)}(k)] = [16^\circ, 2^\circ k, 2^\circ k^2].$$

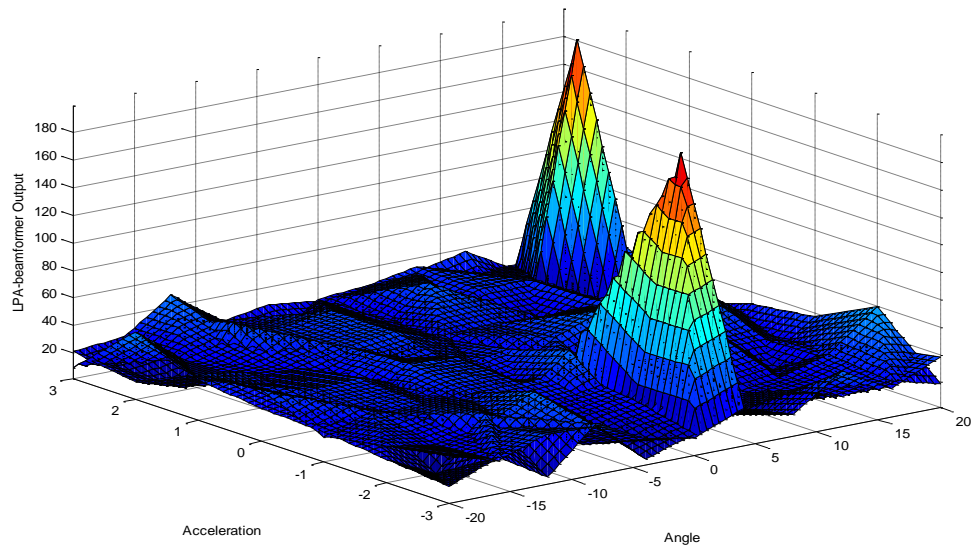

Fig. 2. (b): The output of the LPA beamformer for 2 sources case, at 5dB for  $(c_0, c_2)$  pair. The DOA parameters of the two sources are:

$$[\theta_1(k), \theta_1^{(1)}(k), \theta_1^{(2)}(k)] = [4^\circ, -2^\circ k, -2^\circ k^2] \text{ and}$$

$$[\theta_2(k), \theta_2^{(1)}(k), \theta_2^{(2)}(k)] = [16^\circ, 2^\circ k, 2^\circ k^2].$$

**Case 3: (Performance comparison for single source case)**

Consider single near-field narrowband accelerated source located at  $(r_1, \theta_1) = (1.5\lambda, 4^\circ)$ . Figure 3 (a, b) shows the standard deviation for DOA and range; respectively, versus SNR for both the LPA beamformer and the REM1 method. The time-varying DOA and range parameter vectors are

$[\theta_1(k), \theta_1^{(1)}(k), \theta_1^{(2)}(k)] = [4, -2^\circ k, 2^\circ k^2]$  and  
 $[r_1(k), r_1^{(1)}(k), r_1^{(2)}(k)] = [1.5\lambda, (1\lambda)k, (1\lambda)k^2]$ ; respectively. It is observed that the proposed method has lower error compared to the REM1 method in the rapidly moving sources scenarios. Both algorithms assume the motion model in (13) and the range model (15).

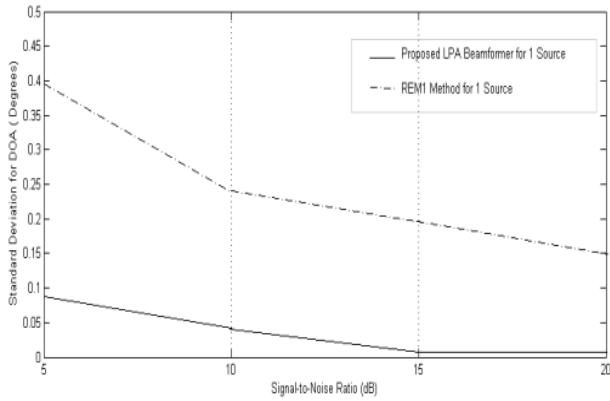

Fig. 3. (a): Compares the standard deviation for DOA angle estimation error versus SNR for a single source that has  $(r_1, \theta_1) = (1.5\lambda, 4^\circ)$  for the LPA and the REM1 method.

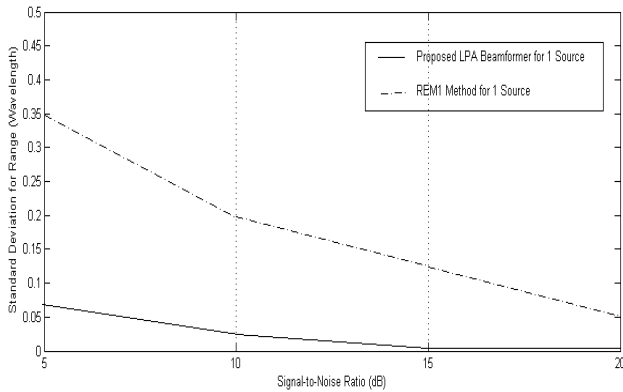

Fig. 3. (b): Compares the standard deviation for range estimation error versus SNR for a single source that has  $(r_1, \theta_1) = (1.5\lambda, 4^\circ)$  for the LPA algorithm and the REM1 method.

**Case 4 : ( Performance comparison for Two sources case )**

Assume two near-field uncorrelated narrowband moving sources located at  $(r_1, \theta_1) = (2\lambda, 4^\circ)$  and  $(r_2, \theta_2) = (4\lambda, 16^\circ)$ . The time-varying DOA parameters for the two sources is  $[\theta_1(k), \theta_1^{(1)}(k), \theta_1^{(2)}(k)] = [4, -2^\circ k, 2^\circ k^2]$   
 $[\theta_2(k), \theta_2^{(1)}(k), \theta_2^{(2)}(k)] = [16, 2^\circ k, -2^\circ k^2]$ .

While the range parameters for the two sources are:

$$[r_1(k), r_1^{(1)}(k), r_1^{(2)}(k)] = [2\lambda, (1\lambda)k, (1\lambda)k^2],$$

$$[r_2(k), r_2^{(1)}(k), r_2^{(2)}(k)] = [4\lambda, (2\lambda)k, (2\lambda)k^2].$$

It is clear from Fig. 4 that the proposed LPA beamformer is superior to the REM1 method.

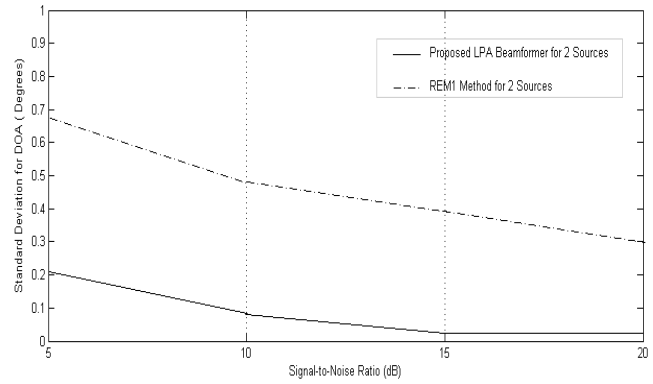

Fig. 4. (a): Compares the standard deviation for DOA angle estimation error versus SNR for 2 sources located at  $(r_1, \theta_1) = (2\lambda, 4^\circ)$  and  $(r_2, \theta_2) = (4\lambda, 16^\circ)$  for the proposed algorithm and the REM1 method.

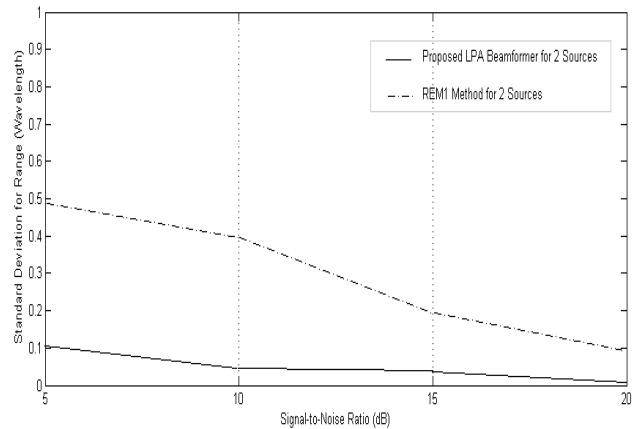

Fig. 4. (b): Compares the standard deviation for range estimation error versus SNR for 2 sources located at  $(r_1, \theta_1) = (2\lambda, 4^\circ)$  and  $(r_2, \theta_2) = (4\lambda, 16^\circ)$  for the proposed algorithm and the REM1 method.

**V. CONCLUSION**

The proposed method represented more accurately the near-field scenarios, typical of indoor environments. Where, in this paper an efficient nonparametric approach based on LPA beamformer for DOA and range parameters estimation for near-field moving source tracking is proposed. By exploiting the acceleration of the moving source, the standard deviation of the angle as well as range estimation using LPA beamformer is less than compared to the REM1. The simulations show that, this proposed nonparametric technique has superior performance over the REM1 method. These advantages appropriate the proposed algorithm for rapidly moving sources. The simulation verifies the effectiveness of the LPA beamformer with the near-field scenarios.

**REFERENCES**

[1] R. Schmidt, "Multiple emitter location and signal parameter estimation," IEEE Trans. Antennas Propagation, Vol. 34, No. 3, pp. 276–280, 1986.  
 [2] R. Roy and T. Kailath, "ESPRIT-estimation of signal parameters via rotational invariance techniques," IEEE Trans. Acoustic, Speech and Signal Process, Vol. 37, No. 7, pp. 984–995, 1989.

- [3] Y. Huang and M. Barkat, "Near-field multiple source localization by passive sensor array," *IEEE Transactions on Antennas and Propagation*, Vol. 39, pp. 968-975, 1991.
- [4] E. Grosicki, K. Abed-Meraim and Y. Hua, "A weighted linear prediction method for near-field source localization," *IEEE Trans. Signal Processing*, Vol. 53, pp. 3651-3660, 2005.
- [5] R. Boyer and J. Picheral, "Second-order near-field localization with automatic paring operation," *ICASSP*, pp. 2569-2572, 2008.
- [6] X. Qian, L. Hong, "A Novel Near-Field Source Localization Algorithm," 2nd International Conference on Signal Processing Systems (ICSPS), Vol.2, pp.188-191, 2010.
- [7] Z. Wang, F. Tian, Y. Yang and L. Xu, "Moving Source Localization in Near-field by a Stationary Passive Synthetic Aperture Array," *APSIPA ASC*, 2011.
- [8] N. Kabaoglu, H.A. Cirpan, S. Paker, "Unconditional Maximum Likelihood Approach for Localization of Near-Field Sources in 3D Space," Fourth IEEE International Symp. on Signal Processing and Information Technology, pp. 233-237, 2004.
- [9] S. Cekli, E. Cekli, N. Kabaoglu and H.A. Cirpan, "EM-Based Recursive Tracking Algorithm for Near-Field Moving Sources," *IEEE Intelligent Vehicles Symposium Conference*. pp. 381-385, 2007.
- [10] H.M. Elkamchouchi, M.E. Nasr, A.S. Ashour, "Modified LPA beamformer for localizing and tracking rapidly accelerated moving sources," *NRSC B4*, pp. 1-8, 2004.
- [11] H.M. Elkamchouchi, M.E. Nasr, A.S. Ashour, "Nonparametric approach for direction-of-arrival estimation of accelerated moving sources using cubic array," *Alexandria Engineering JournalAEJ*, 2005.
- [12] N. Kabaoglu, H.A. Cirpan, S. Paker, "EM Based Stochastic Maximum Likelihood Approach for Localization of Near-Field Sources in 3-D," *Frequenz, Journal of Telecommunications*, 2004, Vol. 58, pp. 178-184, 2004.
- [13] V. Katkovnik and A .B. Gershman, "Performance Study of the Local Polynomial Approximation Based Beamforming in the Presence of Moving Sources," *IEEE Trans. on Antennas and Propagation*, Vol.50, pp. 1151-1157, 2002.

#### AUTHORS PROFILES

**Amira Ashour**, B.Sc in electrical engineering, 1997. The M.Sc in "Enhancement of Electromagnetic Non-Destructive Evaluation Performance Using Advanced Signal Processing Techniques," Faculty of Engineering, Egypt, 2000. She has been awarded the Ph.D degree in Electronic and Communication Engineering in the field of Smart Antenna, Faculty of Engineering, Tanta University, Egypt, 2005. She is now the head of the Computer Science Department, College of Computers and Information Technology, Taif University, Kingdom of Saudi Arabia. She has papers in the field of smart antenna, adaptive antenna arrays and signal processing.

# Survey of Error Correction Mechanisms for Video Streaming over the Internet

Jafar Ababneh<sup>1</sup> and Omar Almomani<sup>2</sup>

Department of Network and Computer Information System  
The World Islamic Sciences & Education University, Jordan

**Abstract**—This overview is targeted at determining state-of-the-art on Error control mechanisms for video streaming over the Internet. The aims of error control mechanisms are to provide and protect the data from errors caused by packet loss due to congestion and link failure. The error control classified into two categories: Error correction coding and Error detection coding. Error control mechanisms for video applications can be classified into four types: forward error correction (FEC), retransmission, error resilience, and error concealment. In this paper, we provide a survey on the existing error control mechanisms, representative error mechanisms systems. We describe the challenges and solutions of each error control mechanisms. Finally we show the Factors effect in the video quality through transmission over Internet.

**Keywords**—Forward Error Correction (FEC; Retransmission; Error Resilience; Error Concealment; video quality; Video Streaming over the Internet; networking quality of service

## I. INTRODUCTION

In a video communication system, the video is first compressed and then segmented into fixed or variable length packets and multiplexed with other types of data. Unless a dedicated link that can provide a guaranteed quality of service (QoS) is available between the source and the destination, data bits or packets may be lost or corrupted, due to either traffic congestion or link failure.

A number of different types of losses may occur, depending on the particular network under consideration. For example, wired packet networks such as the Internet are afflicted by packet loss, where congestion may cause an entire packet to be discarded (lost).

Packet loss can have a destructive effect on the reconstructed video which makes the presentation displeasing to human eyes. Therefore, the video transmission system designs with error control and congestion control [1] to minimize the packet loss in the Internet. Nevertheless the packet loss is inevitable in the Internet[1-3]. The error control mechanisms have been proposed in order to enhance the video quality in presence of packet loss.

All error correcting mechanisms are based on the same basic principle: redundancy is added to information in order to correct any errors that may occur in the process of transmission[4]. The error control coding classified into two

categories as shown in Fig., 1 : Error correction and Error detection. Error correction is the means whereby errors which may be introduced into digital data as a result of transmission through a communication channel can be corrected based upon received data. Error correcting codes, such as parity, LDPC<sup>1</sup>, Reed-Solomon[5], and Hamming codes[6] used by FEC to correct the error. Parity coding and Reed-Solomon coding are often recommended in (IETF)<sup>2</sup> and Real-Time Transport Protocol (RTP),[7]. Error detection is the means whereby errors can be detected based upon received information without correction. Since the packet loss causes a degradation of visual quality, error control mechanisms can be employed to overcome this problem. Error control mechanisms for video applications can be classified into four types[1,8],forward error correction (FEC), retransmission, error resilience, and error concealment. As show in “Fig. 2.”.

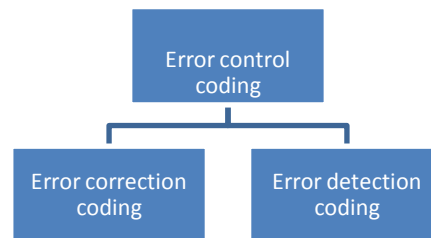

Fig. 1. Error Control Coding

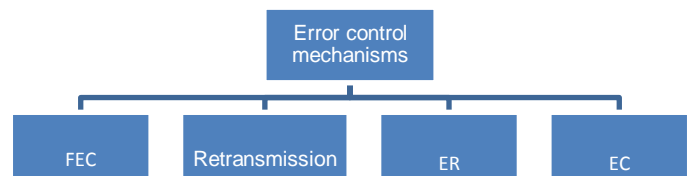

Fig. 2. Error Control Mechanisms

The basic idea of FEC is to add redundant packets on compressed source packet to enable error detection and correction. Redundant packets are transmitted so that the original message can be reconstructed in case the packets are lost.

Retransmission mechanisms based on the receiver notifies the sender which packets were received or lost and the sender

<sup>1</sup> Low Density Parity Check Codes

<sup>2</sup> www.ietf.org, Internet Engineering Task Force

have to resend lost packets. ARQ is example of retransmission.

Error-resilient schemes are performed at both the source and the receiver side. Error-resilient deals with packet loss on the compression layer like the error concealment. These schemes try to prevent error propagation or limit the scope of the damage caused by packet losses on the compression layer by adding redundancy data at the source coding.

Error Concealment is Receiver-based error, which means this method attempts to recover the lost information by estimation and interpolation without relying on additional information from the encoder. Fig.,3., shows error control mechanisms architecture.

This paper is organized as follows: In Section 2, we present comprehensive overview of FEC. Section 3 explained the Retransmission mechanisms. Section 4, error resilient mechanisms is explained, in section 5, we explain the error concealment mechanisms. Section 6, presents review of all mechanisms, and in section 7, conclusion is presented.

## II. FORWARD ERROR CORRECTION

The aim of FEC is to add specialized redundancy that can be used to recover data from errors. A number of forward error correction techniques have been developed to repair losses of data during transmission[9-14].The basic idea of FEC is to add redundant packets on compressed source packet to enable error detection and correction. Redundant packets are transmitted so that the original message can be reconstructed in case the packets are lost. If there are K data packets, FEC will add N - K redundant packets and the FEC overhead is N/K[11]. If the losses are less than a threshold, then the transmitted data can be perfectly recovered loss data at the received.

However, if the losses are greater than the threshold, then only a portion of the data can be recovered. Fig.,4., shows the simple FEC mechanism.

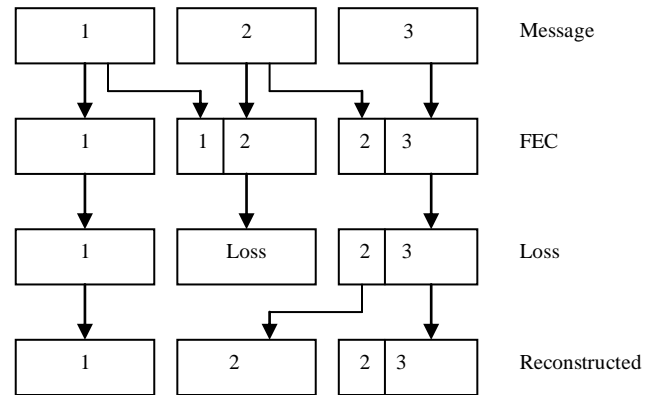

Fig. 3. the simple FEC mechanism

FEC schemes can be classified into three categories: as show in fig.,5.

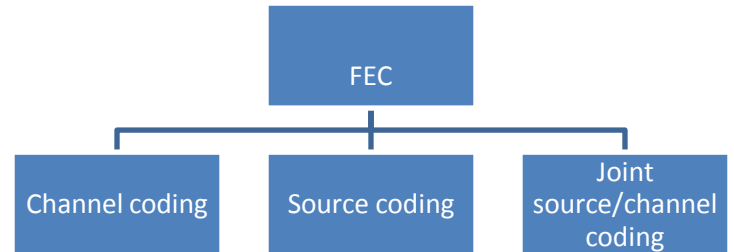

Fig. 4. FEC Categories

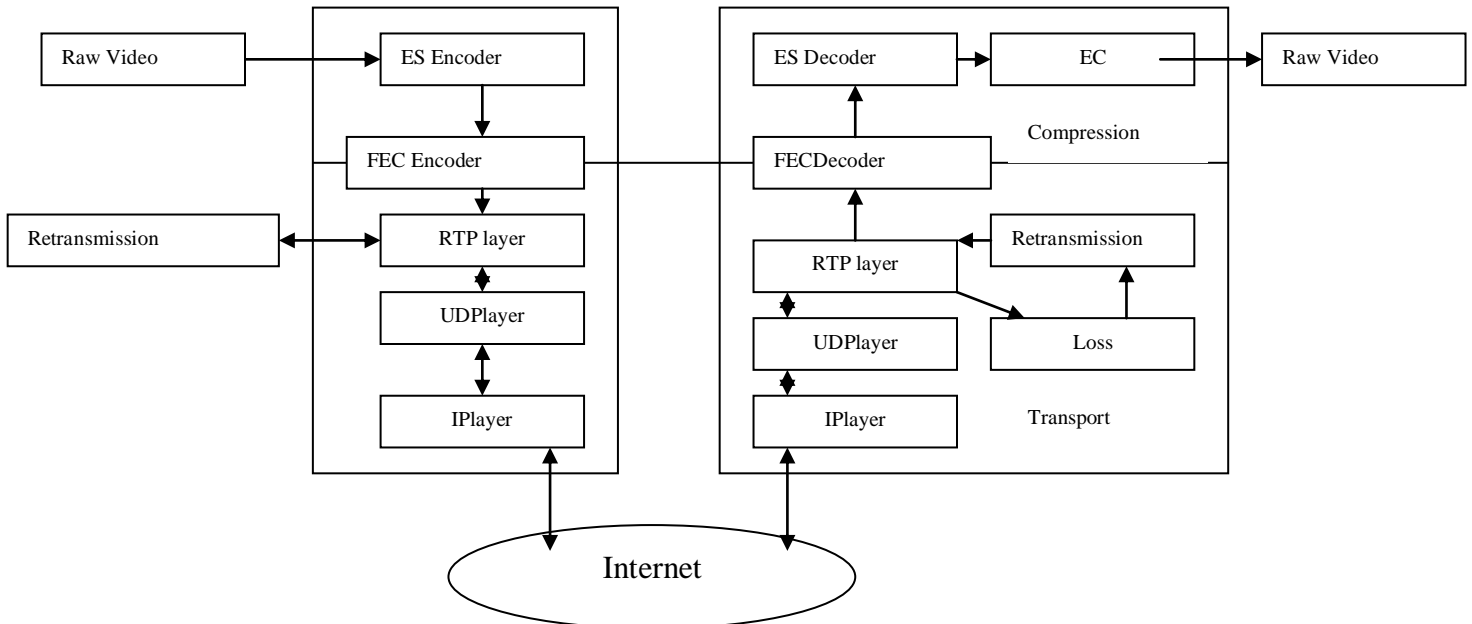

Fig. 5. Error control mechanisms architecture [1].

### A. Channel Coding Based FEC

Channel coding is often used in digital communication systems to protect the data from errors. There are two main types of channel codes, namely block codes and convolution codes[15]. Block codes are based strictly on finite field arithmetic and abstract algebra. They can be used to either detect or correct errors. The most commonly used block codes are Hamming codes, BCH codes, and Reed Solomon codes. Convolutional codes are used channel codes in practical communication systems. These codes are used for real time error correction. The main decoding strategy for convolutional codes is based on the widely used Viterbi algorithm. For more information about codes see [16].

Channel coding used in terms of block codes for Internet applications. Specifically, a video stream is first chopped into segments, each of which is packetized into  $k$  packets; then for each segment, a block code is applied to the  $k$  packets to generate a  $n$ -packet block [1], where  $n > k$ . Due to its ability to recover from any  $k$  out of  $n$  packets regardless of which packets are lost[17]. There are some disadvantages for channel coding:

- a) It increases the transmission rate.
- b) It increases delay.
- c) It is not adaptive to varying loss characteristics.

### B. Source Coding Based FEC

Source coding-based FEC (SFEC) is a variant of FEC for Internet video [17]. Like channel coding, SFEC also adds redundant information to recover from loss. For example, the  $n$ th packet contains the  $n$ th group of blocks (GOB) and redundant information about the  $(n - 1)$ th GOB, which is a compressed version of the  $(n - 1)$ th GOB with larger quantize. The redundant information added by SFEC is more compressed versions of the raw video. As a result, when there is packet loss, channel coding could achieve perfect recovery while SFEC recovers the video with reduced quality. One advantage of SFEC over channel coding is lower delay.

### C. Joint Source/Channel Coding

Joint source/channel coding is an approach to optimal rate allocation between source coding and channel coding. Joint source/channel coding is used to perform the following responsibilities:

- Finding an optimal rate allocation between source coding and channel coding for a given channel loss characteristic.
- Designing a source coding scheme (including specifying the quantizer) to achieve its target rate.
- Designing/choosing channel codes to match the channel loss characteristic and achieve the required robustness.

## III. RETRANSMISSION

Retransmission mechanism do not consider as a method to recover lost packets in real-time video since a retransmitted packet may miss its playout time like automatic repeat request (ARQ)[18].

Retransmission requires a back-channel between receiver and sender. So the receiver notifies the sender which packets were received or lost and the sender re-sends lost packets. Retransmission efficiently uses bandwidth and easily adapts to changing channel conditions. Because the Retransmission mechanism requires a back-channel, it isn't suitable to use for broadcast, multicast, and unicast without back-channel. Retransmission always involves additional transmission delay and thus has been widely known ineffective for interactive real-time video applications.

In many applications the extra delay incurred from using retransmission is acceptable, e.g. FTP, telnet. In these cases, when guaranteed delivery is required (and a backchannel is available) then feedback-based retransmits provide a powerful solution to channel losses. On the other hand, when a back channel is not available or the extra delay is not acceptable, then retransmission is not an appropriate solution. If the one-way trip time is short with respect to the maximum allowable delay, a retransmission-based approach is called delay constrained retransmission. Where packets are only retransmitted if they can arrive by their time deadline, or priority-based retransmission, where more important packets are retransmitted before less important packets.

## IV. ERROR RESILIENT

Error-resilient mechanism is developed to mitigate the effect of packet losses or to prevent and limit the distortion error propagation from compression perspective by adding redundancy at the source coding level. The error-resilient composed of resynchronization marking, data partitioning, data recovery like reversible variable-length coding (RVLC) [19-20] for wireless video. These tools are targeted at error-prone environment like wireless channel and may not be suitable to Internet environment. For video transmission over the Internet, the limit of a packet already provides a synchronization point in the variable-length coded bit-stream at the receiver side.

Packet loss may cause the loss of all the motion data and its associated shape/texture data, mechanisms such as resynchronization marking, data partitioning, and data recovery may not be useful for Internet video communications. Therefore, in the packet-switched networks, error resilient source coding may use the optimal mode selection[21- 22] for each packet or multiple description coding (MDC)[23-24]. These are the techniques used for robust Internet video transmission.

### A. Optimal Mode Selection

There are two coding modes for black, Inter-mode. With this mode, loss of packet may degrade video quality over a large number of frames. Intra-mode can effectively stop error propagation at the cost of compression efficiency. Inter-mode can achieve compression efficiency at the risk of error propagation. Therefore, the aim of optimal mode selection method is to find the trade-off between coding efficiency and error robustness, since different prediction modes typically result in different levels of coding efficiency and robustness. Many research have been done about the optimal mode selection[19, 21, 22].



Optimal mode selection based on rate distortion (R-D) aim to minimize the quantization distortion between the original block and reconstructed block according to bit budget [25-26]. The R-D optimized mode selection consider as a classical approach. The classical R-D optimized mode selection cannot achieve global optimality under the error-prone environment since it does not consider the network congestion status and the receiver behavior. To overcome this problem the end-to-end approach has been proposed [22], which consider the source behavior , path characteristic and receiver behavior.

### B. Multiple Description Coding

Multiple Description Coding (MDC)[2, 27] is another way to achieve trade-off between compression efficiency and error robustness.

Fig. 6.shows, the structure of multiple description coding. A raw video sequence is compressed into multiple streams (descriptions). Each description can provide good visual quality even if only one description is received while if more one description is received that will improved the visual quality (Highest). When lose happened multiple description decoder will borrow the corresponding frame from another description. MDC has two important features. First, robustness: even if one description received and other lost, it can give good visual quality. Each description can be decoded independently.

Second, if receiver received more than one description, it can combine all description received together and provide better visual quality.

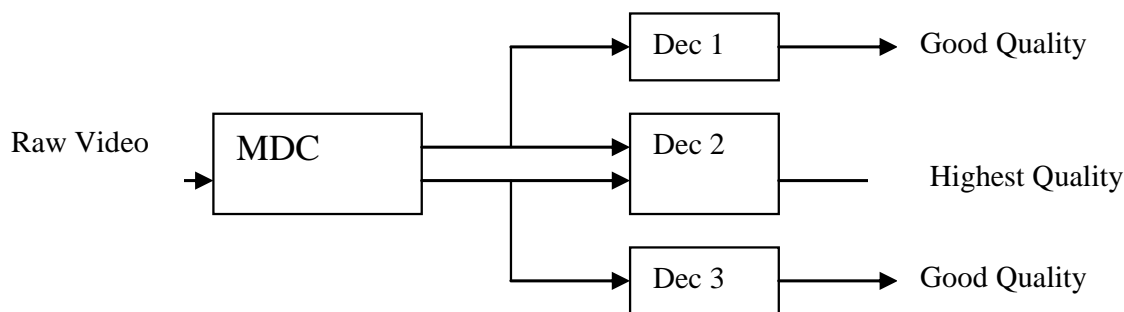

Fig. 6. The structure of multiple description coding [2]

## V. ERROR CONCEALMENT

Error concealment is a post-processing technique executed only by decoders/receivers. Unlike the error resilient, that is applied to avoid the packet loss before it happened (this call preventive approach). Error concealment is applied by the receiver to handle the packet loss that already occurred[8] (this is called reactive approach).Error concealment is used to conceal the lost data and make the presentation less displeasing to human eyes. The error concealment has been useful to use for video and audio streaming over Internet [28].

There are two basic approaches for error concealment to handling the packet loss. Spatial and temporal domain interpolation[1, 17, 28, 29]. In the spatial interpolation, missing data values are reconstructed using neighboring spatial information, whereas in temporal interpolation, the lost data is reconstructed from previous frame. Spatial interpolation is used to reconstruct the missing data in intra-coded frames (I-frame), while temporal interpolation is used to reconstruct the missing data in inter-coded frames (B-frame).

Several error concealment schemes have been proposed to be applicable to Internet video application [1]. In first scheme, the receiver replaces the whole frame with the previous reconstructed frame. Second scheme, the receiver replaces a corrupted block with the block at the same location from the previous frame.

Third scheme, the receiver replaces the corrupted block with the block from the previous frame pointed by a motion

vector. Motion vectors are used to compress video by storing the changes to an image from one frame to the next.

## VI. ERROR MECHANISMS: REVIEW

The current Internet Architecture does not meet with the needs of new applications like video streaming, which require high data throughput (bandwidth) and have low-latency requirements, current Internet transmits all packets with equal importance However. Video streaming over Internet is requiring number of requirements, such as minimum bandwidth, delay and loss.

When we transported video over Internet, we have to take the congestion and error control in our consideration. This survey aims to introduce the error control mechanisms that are used to protect the data from errors caused by packet loss due to congestion and link failure. Since the packet loss is inevitable in the Internet[1, 3]several Error control mechanisms have been proposed for video applications to reduce the packet loss. These mechanisms can be classified into four types: forward error correction (FEC), retransmission, error resilience, and error concealment as shown in table 1.

The basic idea of FEC[1, 8] is to use the channel coding or joint source/channel coding to add redundancy packets on compressed source packet to enable error detection and correction. Redundant packets are transmitted so that the original message can be reconstructed in case the packets are lost. If there are K data packets, FEC will add N - K redundant packets and the FEC overhead is N/K.

TABLE I. ERROR CONTROL MECHANISMS COMPARISON

\*FEC: Forward Error Control  
\*ER: Error Resilient

Criteria	FEC*	Retransmission	ER*	EC*
Layer	Transport & Compression	Transport	Compression	Compression
Performed Place	Source & Receiver	Source & Receiver	Source & Receiver	Receiver
Error Techniques	Channel coding, Source coding and Joint source/channel coding	Back channel (Retransmitted)	Optimal mode selection and Multiple Description coding	Spatial Interpolation, Temporal interpolation.
Coding	Channel coding	Channel coding	Source coding	Source coding

\*EC: Error Concealment

Many researchers have been done in applying FEC packet, which is almost achieved by erasure codes [30, 31], the most common erasure codes are RS (Reed-Solomon). Other erasure codes have been considered is Tornado code[10].

Retransmission[1] mechanisms based on the receiver notifies the sender which packets were received or lost and the sender have to resend lost packets. Retransmission requires back channel; hence it is easy to adapt changing channel conditions, but make it unsuitable to broadcast. Retransmission requires large transmission delay, so retransmission error controls mechanism unsuitable to be real-time application.

Error Concealment[8, 28] is Receiver-based error, which means this method attempts to recover the lost information by estimation and interpolation without relying on additional information from the encoder. Error concealment offers a feasible technique for coping with packet loss from the compression perspective. Error concealment has two approaches, spatial and temporal interpolation.

Error-resilient[32],[33]schemes deal with packet loss on the compression layer like the error concealment. These schemes try to prevent error propagation or limit the scope of the damage caused by packet losses on the compression layer by adding redundancy data at the source coding, this technique is composed of resynchronization marking, data partitioning and data recovery.

Many study have been done the error resilient source coding problem by using the optimal mode selection with (R-D)[19, 34].Error-resilient[32],[33]schemes deal with packet loss on the compression layer like the error concealment. These schemes try to prevent error propagation or limit the scope of the damage caused by packet losses on the compression layer by adding redundancy data at the source coding, this technique is composed of resynchronization marking, data partitioning and data recovery.

Many study have done the error resilient source coding problem by using the optimal mode selection with (R-D)[19, 34].

There are three factors effect in the video quality [1] fig. 7.show these factors. To achieve good performance of video streaming it is necessary to take into consideration the path characteristics, receiver behavior and source behavior[1,21].

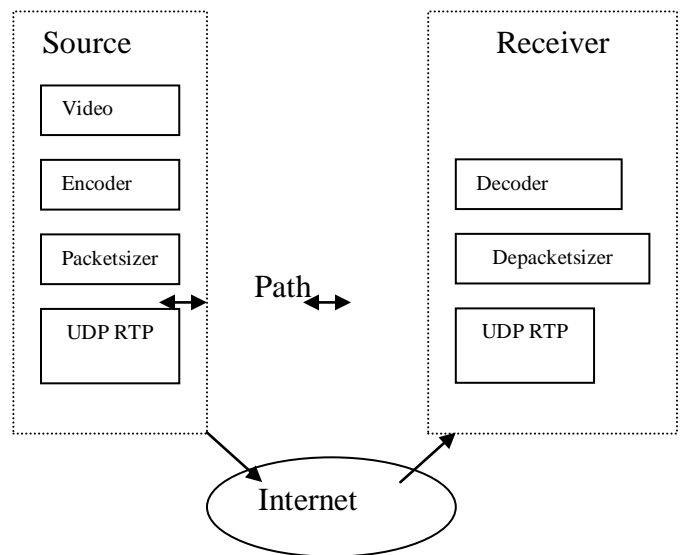

Fig. 7. Factors effect in the video quality

VII. CONCLUSION AND FUTURE WORK

In this paper, we have described the error control mechanisms for video application, which can reduce the packet loss in order to provide good video quality.

Existing error control mechanisms can be classified into four types, namely, forward error correction (FEC), retransmission, error resilience, and error concealment. The

first two are in channel coding and the latter two are in source coding.

FEC is to add redundant bits on compressed source bits to enable error detection and correction. Advantage of FEC is its small transmission delay, but the FEC is ineffective if there are more than N-K consecutive packets lost. FEC schemes can be classified into three categories: a) Channel coding, b) Source coding-based FEC; and c) joint source/channel coding.

In the retransmission the receiver notifies the sender which packets were received / lost and the sender re-sends lost packets. Retransmission includes delay-constrained retransmission so it is ineffective for interactive real-time video applications. Error-resilient coding schemes are developed to mitigate the effect of packet losses or to prevent error propagation from compression perspective. The error-resilient composed of resynchronization marking, data partitioning and data recovery. Error resilient source coding may use the optimal mode selection for each packet or multiple description coding (MDC).

Error concealment is a post-processing technique executed only by decoders / receivers. The error concealment mechanism performs some forms of Spatial / temporal interpolation to estimate the lost information from the correctly received data.

Any researcher working in the error control mechanisms to provide good video quality has to concentrate in of the following factors source coding, receiver coding and channel (path) to achieve good performance.

#### ACKNOWLEDGMENT

The authors are grateful to the World Islamic Sciences and Education University, Amman-Jordan, for supporting this research article.

#### REFERENCES

- [1] D. Wu., Y. T. Hou., and Y.-Q. Zhang., "Transporting Real-Time Video over the Internet: Challenges and Approaches," *Proceedings of the IEEE*, vol. 88, pp. 1855-1877, Dec 2000.
- [2] Y. Wang, A. R. Reibman, and S. Lin, "Multiple Description Coding for Video Delivery," *Proceedings of the IEEE*, vol. 93, pp. 57-70, 2005.
- [3] D. Wu., Y. T. Hou., W. Zhu., Y.-Q. Zhang., and J. M. Peha., "Streaming Video over the Internet: Approaches and Directions," *Circuits and Systems for Video Technology, IEEE Transactions on*, vol. 11, pp. 282-300, Mar 2001.
- [4] Robert.H and Morelos-Zaragoza, *The Art of Error Correcting Coding*. England: John Wiley & Sons Ltd., 2006.
- [5] S. Wicker and V. Bhargava, *Reed-Solomon Codes and Their Applications*: John Wiley & Sons, Inc. New York, NY, USA, 1999.
- [6] T. Moon, *Error Correction Coding: Mathematical Methods and Algorithms*: Wiley-Interscience, 2005.
- [7] H. Schulzrinne, S. Casner, R. Frederick, and V. Jacobson, "RTP: A Transport Protocol for Real-Time Applications," RFC 1889, The Internet Engineering Task Force, January 1996. <http://www.ietf.org/rfc/rfc1889.txt>.
- [8] Y. Wang and Q.-F. Zhu, "Error Control and Concealment for Video Communication: A Review," *Proceedings of the IEEE*, vol. 86, pp. 974 - 997, May 1998.
- [9] A. Nafaa, T. Taleb, and L. Murphy, "Forward Error Correction Strategies for Media Streaming over Wireless Networks," *Communications Magazine, IEEE*, vol. 46, pp. 72-79, 2008.
- [10] Q. Zhao, C. Li, X. Zhang, and D. A.-L. Liu, Dongtao, "A New FEC Scheme for Real-time Transmission of High Definition Video over IP Network," presented at Intelligent Pervasive Computing, 2007. IPC. The 2007 International Conference on, 2007.
- [11] S.-R. Kang and D. Loguinov, "Modeling Best-Effort and FEC Streaming of Scalable Video in Lossy Network Channels," *Networking, IEEE/ACM Transactions on*, vol. 15, pp. 187-200, 2007.
- [12] C. S.-H.G., Xing Zheng, Qian Zhang, Wen-Wu Zhu, and Ya-Qin Zhang, "Video Loss Recovery with FEC and Stream Replication," *Multimedia, IEEE Transactions on*, vol. 8, pp. 370-381, 2006.
- [13] R. Malik, A. Munjal, and S. Chakraverty, "Offline Adaptive Forward Error Correction (AFEC) for Reliable Multicast," presented at Networking, Sensing and Control, 2006. ICNSC '06. Proceedings of the 2006 IEEE International Conference on, 2006.
- [14] X. Yu, J. W. Modestino, and I. V. Bajic, "Performance Analysis of the Efficacy of Packet-level FEC in Improving Video Transport over Networks," presented at Image Processing, 2005. ICIP 2005. IEEE International Conference on, 2005.
- [15] Philip A. Chou and M. v. d. Schaar, *Multimedia Over IP and Wireless Networks Compression, Networking and Systems*. United States of America: Elsevier Inc., 2007, pp. 196-216.
- [16] T. K. Moon, *Error Correction Coding Mathematical Methods and Algorithms*. New Jersey.: Wiley & Sons, Inc., 2005.
- [17] K. R. Rao, Zoran S. Bojkovic, and D. A. Milovanovic, *Introduction To Multimedia Communications Applications, Middleware, Networking*. New Jersey.: John Wiley & Sons, Inc., 2006.
- [18] E. Weldon Jr, "An Improved Selective-Repeat ARQ Strategy," *Communications, IEEE Transactions on [legacy, pre-1988]*, vol. 30, pp. 480-486, 1982.
- [19] G. Cote, S. Shirani, and F. Kossentini, "Optimal Mode Selection and Synchronization for Robust Video Communications over Error-Prone Networks," *Selected Areas in Communications, IEEE Journal on*, vol. 18, pp. 952-965, 2000.
- [20] B. Girod and N. Farber, "Feedback-based Error Control for Mobile Video Transmission," *Proceedings of the IEEE*, vol. 87, pp. 1707-1723, 1999.
- [21] R. Zhang, S. L. Regunathan, and K. Rose, "Video Coding with Optimal inter/intra-Mode Switching for Packet Loss Resilience," *Selected Areas in Communications, IEEE Journal on*, vol. 18, pp. 966-976, 2000.
- [22] D. Wu, Y. T. Hou, B. Li, W. Zhu, Y.-Q. Zhang, and H. J. Chao, "An End-to-End Approach for Optimal Mode Selection in Internet Video Communication: Theory and Application," *Selected Areas in Communications, IEEE Journal on*, vol. 18, pp. 977-995, 2000.
- [23] M. Pereira, M. Antonini, and M. Barlaud, "Multiple description coding for Internet video streaming," presented at Image Processing, 2003. ICIP 2003. Proceedings. 2003 International Conference on, 2003.
- [24] S. Che-Chun, Y. J. J., and C. H. H., "H.264/AVC-Based Multiple Description Coding Scheme," presented at Image Processing, 2007. ICIP 2007. IEEE International Conference on, 2007.
- [25] A. Ortega and K. Ramchandran, "Rate-Distortion Methods for Image and Video Compression," *Signal Processing Magazine, IEEE*, vol. 15, pp. 23-50, 1998.
- [26] T. Wiegand, M. Lightstone, D. Mukherjee, T. G. Campbell, and S. K. Mitra, "Rate-Distortion Optimized Mode Selection for Very Low Bit Rate Video Coding and the Emerging H.263 Standard," *Circuits and Systems for Video Technology, IEEE Transactions on*, vol. 6, pp. 182-190, 1996.
- [27] A. El Essaili, S. Khan, W. Kellerer, and E. A.-S. Steinbach, Eckehard, "Multiple Description Video Transcoding," presented at Image Processing, 2007. ICIP 2007. IEEE International Conference on, 2007.
- [28] B. W. Wah, X. Su, and D. Lin, "A Survey of Error-Concealment Schemes for Real-Time Audio and Video Transmissions over the Internet," presented at Proceedings. IEEE International Symposium on Multimedia Software Engineering., 2000.
- [29] W. Kung, C. Kim, and C. Kuo, "Spatial and Temporal Error Concealment Techniques for Video Transmission over Noisy Channels," *IEEE Trans. Circuits Syst. Video Technol*, vol. 16, pp. 789-802, 2006.

- [30] R. Zhang, S. Regunathan, and K. Rose, "End-to-end Distortion Estimation for RD-Based Robust Delivery of Pre-compressed Video," *Signals, Systems and Computers, 2001. Conference Record of the Thirty-Fifth Asilomar Conference on*, vol. 1, 2001.
- [31] M. Gallant and F. Kossentini, "Rate-Distortion Optimized Layered Coding with Unequal Error Protection for Robust Internet Video," *Circuits and Systems for Video Technology, IEEE Transactions on*, vol. 11, pp. 357-372, 2001.
- [32] J. Villasenor, Y. Zhang, and J. Wen, "Robust Video Coding Algorithms and Systems," *Proceedings of the IEEE*, vol. 87, pp. 1724-1733, 1999.
- [33] Y. Wang, S. Wenger, J. Wen, and A. K. Katsaggelos, "Error Resilient Video Coding Techniques," *Signal Processing Magazine, IEEE*, vol. 17, pp. 61-82, 2000.
- [34] D. Wu, Y. Li, B. Zhang, and H. Chao, "An End-to-End Approach for Optimal Mode Selection in Internet Video Communication: Theory and Application," *Selected Areas in Communications, IEEE Journal on*, vol. 18, pp. 977-995, 2000.

#### AUTHORS PROFILES



Dr. Jafar Ababneh is currently an assistant professor at the World Islamic Sciences and Education (WISE), he is a head of the departments of computer information systems and network systems in the school of information technology beside assistance dean of information technology faculty. He received his PhD degree from Arab Academy for Banking & Financial Sciences (Jordan) in 2009. He received his M.Sc degree in computer engineering from University of the Yarmouk (Jordan) in 2005. He earned his B.Sc in Telecommunication engineering from University of Mu'ta (Jordan) in 1991.

He has authored more than 20 search papers, book chapters, and books in reputed international refereed journal and international conference proceedings. His field research lies in development and performance evaluation of multi-queue nodes queuing systems for congestion avoidance at network routers using discrete and continuous time, also his research interests includes computer networks design and architecture, wire and wireless communication, artificial intelligence and expert system, knowledge base systems, security systems, data mining and information.

# Variational Formulation of the Template-Based Quasi-Conformal Shape-from-Motion from Laparoscopic Images

Abed Malti

{abed.malti@gmail.com}

ALCoV-ISIT,

UMR 6284 CNRS / Université d'Auvergne

28 Place Henri Dunant

Clermont-Ferrand, France

**Abstract**—One of the current limits of laparoscopy is the absence of a 3D sensing facility for standard monocular laparoscopes. Significant progress has been made to acquire 3D from a single camera using Visual SLAM (Simultaneous Localization And Mapping), however most of the current approaches rely on the assumption that the observed tissue is rigid or undergoes periodic deformations. In laparoscopic surgery, these assumptions do not apply due to the unpredictable and elastic deformation of the tissues.

We propose a new sequential 3D reconstruction method adapted to reconstructing organs in the abdominal cavity. We draw on recent computer vision methods exploiting a known 3D view of the environment at rest position called a *template*. However, no such method has ever been attempted in-vivo. State-of-the-art methods assume that the environment can be modeled as an isometric developable surface: one which deforms isometrically to a plane. While this assumption holds for paper and cloth-like surfaces, it certainly does not fit human organs and tissue in general. Our method tackles these limits: it uses a non-developable template and copes with natural 3D deformations by introducing quasi-conformal prior. Our method adopts a new two-phase approach. First the 3D template is reconstructed in-vivo using RSfM (Rigid Shape-from-Motion) while the surgeon is exploring – but not deforming – structures in the abdominal cavity. Second, the surgeon manipulates and deforms the environment. Here, the 3D template is quasi-conformally deformed to match the 2D image data provided by the monocular laparoscope. This second phase only relies on a single image. Therefore it copes with both sequential processing and self-recovery from tracking failures.

The proposed approach has been validated using: (i) in-vivo animal data with ground-truth, and (ii) in-vivo laparoscopic videos of a real patient's uterus. Our experimental results illustrate the ability of our method to reconstruct natural 3D deformations typical in real surgery.

**Index Terms**—Laparoscopy, monocular 3D reconstruction, extensible surface.

## I. INTRODUCTION

Over the last few years significant efforts have been made toward developing systems for computer aided laparoscopy. The main goal is to assist the surgeon during the intervention in order to improve their perception of the intra-operative environment as described by [1]. 3D sensing can aid laparoscopy

by providing different view points of the abdominal cavity and is one of the major possible improvements to the current technology.

Various methods for intra-operative 3D sensing have been recently proposed. they can be classified as active and passive. The active approach consists of techniques that acquire depth information by emitting calibrated wave beams (visible like structured light or invisible like infra-red). [2], [3] have proposed an approach based on the detection of a laser beam line is described. This approach requires the insertion of two monocular endoscopes: one for projecting the laser beam and one for observing the projected laser beam. [4] have proposed a prototype of ToF (Time-of-Flight) endoscope for which [5] has set up an incremental algorithm for 3D reconstruction which has shown promising results for the use of ToF endoscopes. Active approaches require one to modify the endoscope's hardware and may alter the surgeon's view. The passive approaches use only 'regular' images from the laparoscopes: both stereo and monocular endoscopes are concerned. [6], [7], [8] have proposed a set of methods based on disparity map computation for stereo-laparoscopy. A Visual SLAM method for dense surface reconstruction using a stereo-laparoscope has been proposed by [9]. In the context of monocular laparoscopy, very few methods were attempted: Visual SLAM with soft deformations by [10], and RSfM by [11]. The accuracy of reconstructed 3D shapes for these methods depends on the ability of the state model to account for complex phenomena occurring in the environment such as the use of surgery tools which may introduce unpredictable deformations. Errors may accumulate through navigation and produce artifacts in the reconstructed 3D shape. Some further developments have been made in the specific context of periodic deformations. Recently, [12] and [13] have proposed a method for 3D reconstruction of the beating heart and deforming liver under cyclic respiration respectively. The cyclic deformation was modeled as a linear combination of basis shapes. These methods cannot be used in laparoscopy where the cyclic deformation assumption does not hold.

The computer vision community has recently established

interesting techniques in template-based monocular 3D reconstruction of deformable surfaces. Template-based methods provide a dense geometric description of the surface rather than just a sparse or partially dense description as in the previously cited methods. This allows one to render the surface from a new viewpoint, recover self-occluded parts, and opens applications based on Augmented Reality. We propose a novel approach to DSfM (Deformable SfM) that is well-adapted to the laparoscopic setting. Specifically, we extend recent 2D-template-based deformable methods for developable (paper-like) surfaces proposed by [14], [15], [16]. These methods reconstruct a 3D surface from sparse feature matches between the known template and a single view. Existing methods were designed for inextensible-developable surfaces. However, inextensibility is not a property generally satisfied by living tissue, and so these methods cannot be applied in laparoscopy. Our contribution is to extend these works to handle the reconstruction of tissues and organs in the abdominal cavity. Our work is based on introducing a deformable prior which handles elastic deformations. It is based on the assumption that for such surfaces, deformations tend to locally preserve angles and tolerate minor changes in area. This type of deformation is called quasi-conformal, and generalizes isometric deformations by allowing local isotropic stretching to happen. While classical NRSfM (Non-Rigid SfM) methods reconstruct soft or cyclic deformations our method reconstructs complex and unpredictable deformations. Moreover the fact that our method is based on the usage of a monocular single view prevents the reconstruction from accumulating errors like sequential NRSfM methods.

This paper extends our previous work, [17], in several directions: (i) we provide a variational formulation of the quasi-conformal 3D reconstruction approach, (ii) we propose a new initialization step specifically designed for extensible surfaces using SOCP (Second Order Cone Programming), (iii) we provide results with 3D reconstruction of in-vivo organs with comparison to ground-truth 3D data, and (iv) all the results are compared to template-based isometric 3D reconstruction from a single view.

**Paper organization.** Section II presents the related work. Section III describes our 3D reconstruction system. Section IV presents the 3D template reconstruction. Section V gives a geometric characterization of smooth surfaces. Section VI gives our variational formulation of the 3D reconstruction of quasi-conformal surfaces. Section VII presents a discretization of the variational problem. Finally section VIII reports experimental results and section IX concludes. Our notation will be introduced throughout the paper.

## II. RELATED WORK

In the absence of priors, the problem of template-based monocular 3D shape recovery is ill-posed because there is an infinite number of 3D surfaces that can project to the same image data. It is then of critical importance to constrain the problem to have a unique consistent solution or at least a small set of plausible solutions. Over the years, different types

of constraints have been proposed which can be categorized in statistical and physical constraints. Statistical constraints often model the deformation as a linear combination of basis vectors which can be learned offline or online. These have been used either for human face reconstruction in the works by [18], [19], [20] or for generic shapes in the works by [21], [22], [23]. Non-linear learning methods were applied in human tracking by [24], [25] and then extended for more generic surfaces by [26]. NRSfM methods also rely on learned linear models to constrain the relative motion of 3D points. Early approaches proposed by [27] used known basis vectors, but the idea was extended to simultaneously recover shape and deformation modes from image sequences as shown in [28], [29].

Early approaches in physics-based modeling involve minimizing the sum of an internal energy representing the physical behavior of the surface and an external energy derived from image data as proposed by [30]. Many variations have been proposed, such as balloon forces as used by [31], deformable quadrics and thin-plates under tension as proposed by [32]. In works by [33], physical constraints are used as priors within a coarse-to-fine shape basis statistical model. Recently, an important physical prior, the isometry constraint, has been introduced by [14], [15] within a robust framework. It imposes that any surface geodesic distance is preserved after deformation.

In our work, we propose a reconstruction method which handles extensible, complex and unpredictable deformation. We propose to introduce a quasi-conformal constraint to model the deformation of the abdominal cavity organs as being locally isotropic with low tolerance to changes in local areas. While this models quite well the environment, a direct consequence is that the template cannot be taken as flat anymore, as was assumed by most previous methods. Our method thus reconstructs a 3D template shape using classical RSfM by taking advantage of the exploration phase where the surgeon navigates with the laparoscope inside the abdominal cavity. The reconstructed model is deformed afterwards at the surgery phase to fit the different shapes taken by the tissues, thereby providing 3D shape at run-time from a single image. Our algorithm is here dubbed DSfM (Deformable SfM). The technical part consists of three major improvements over state-of-the-art: (i) dealing with quasi-conformal instead of isometric surfaces, (ii) using a 3D instead of a flat 2D template and (iii) creating a custom 3D template using RSfM. This paper introduces template-based 3D reconstruction methods to 3D vision in laparoscopy.

## III. OVERVIEW OF DSfM

As depicted in figure 1, our DSfM system has two main phases:

- 1) **3D template reconstruction.** In this phase the 3D structure of the environment is recovered, by assuming that the scene remains approximately rigid as the surgeon

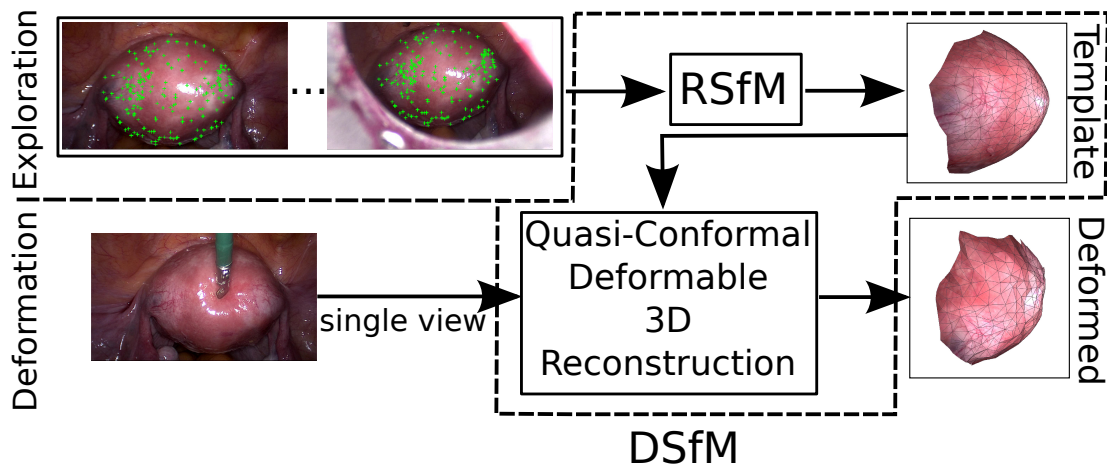

Fig. 1. Principle of our DSfM (Deformable Shape-from-Motion) approach. In the first phase the surgeon explores the abdominal cavity without deforming it; RSfM (Rigid Shape-from-Motion) is used to find the 3D shape called the 3D template. In the second phase, the 3D template is used to infer the 3D shape deformed as observed from only a single laparoscopic view. This makes the approach resistant to registration and tracking errors and well-adapted to live sequential processing.

explores it with the laparoscope. Using a camera self-calibrating RSfM algorithm ([34]), a 3D point cloud representing the organ's shape is reconstructed. The 3D point cloud is then meshed to provide a dense 3D surface, parameterized on the 2D plane via conformal flattening as ([35], [36]). Because this step takes thirty seconds in general, it has no major impact on surgery workflow.

- 2) **Deformable 3D shape reconstruction.** The surgeon is free to proceed and manipulate the target surface, and consequently induces non-rigid deformations with the surgery tools. Here, the template reconstructed in phase 1 is used to perform 3D reconstruction from raw laparoscopic images. The 3D shape is computed by conformally deforming the template such that its 2D projection in the laparoscopic image minimizes the template-to-image registration error.

#### IV. 3D TEMPLATE RECONSTRUCTION

At this stage, the surgeon explores the environment without manipulating it with tools. It is thus assumed that in this phase the environment remains approximately rigid. We capture the exploratory video and we track a set of feature points with the KLT tracker ([37]). Since in the exploration phase the laparoscope is moving around the area of interest, we can have a set of frames where features which were not visible either because of specularities or because of occlusion become visible and then trackable. Note that a feature does not need to be tracked over the whole image set gathered in the exploration phase. We use RSfM to get the camera's intrinsic parameters and a 3D sparse point cloud from the tracked points. Specifically, we use the so-called stratified approach; we first compute a projective reconstruction from detected and tracked interest points. Then we self-calibrate the camera by upgrading the projective to a metric reconstruction. Details and variants of the stratified approach can be found in the literature in [34], [38], [39].

For the projective reconstruction, we combine the fundamental matrices estimated between consecutive views from the point tracks. We finally launch bundle adjustment to finely tune the reconstruction. This process outputs  $N$  3D points  $(x_j, y_j, z_j)$ ,  $j = 1, \dots, N$ . We then reconstruct a dense 3D surface from the point cloud. Assuming that the surface is smooth and well represented by the point cloud, this can be achieved well by Moving Least Squares ([40]). The surface is bounded by a manually marked region of interest in one of the images, and texture mapped using that image. The surface is triangulated to form a mesh with  $N_f$  faces  $\mathcal{F}$  and  $N_v$  vertices  $\mathcal{V}$ . Finally, we map the mesh to the 2D plane via a conformal transform ([35], [36]). The results of applying this method on an in-vivo video sequence from laparoscopy on a uterus is shown in figure 2. The 3D template mesh was reconstructed using a real in-vivo sequence acquired by a Karl Storz HD laparoscope during a hysterectomy surgery. In the exploratory phase, where the operator navigated the laparoscope over the uterus, 300 frames of  $1280 \times 720$  pixels resolution were captured over 12 seconds. 300 correspondences were tracked over the sequence, and the corresponding point cloud was used to reconstruct a dense surface via Moving Least Squares (MLS) surface reconstruction ([40]). The resulting 3D mesh has 500 faces and 285 vertices. Note that the number of frames for template reconstruction does not have any bounded values as far as a decent 3D point cloud representing the 3D shape is obtained. Finally, a quasi-conformal transform is applied to flatten the 3D surface. In the next section, we introduce some basic concepts of differential geometry which will be used in our formulation.



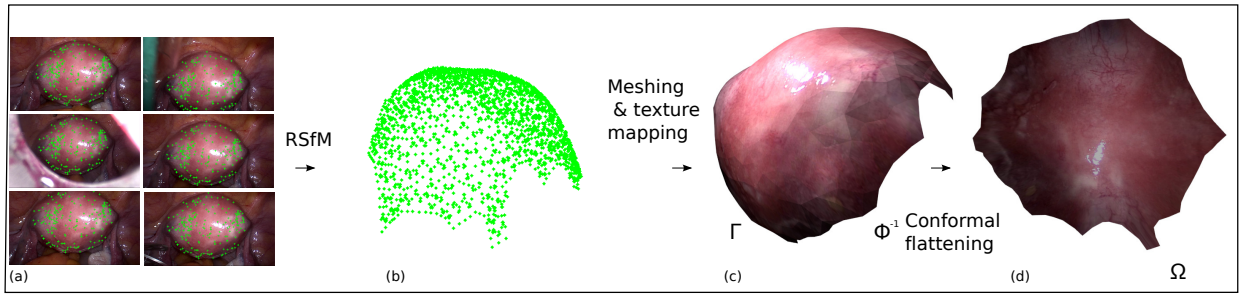

Fig. 2. 3D template reconstruction during the exploration phase using RSfM. (a): feature points are tracked through the video frames. (b): a sparse point cloud is extracted. (c): the 3D points are meshed and texture-mapped. (d): the resulting surface is conformally flattened.

## V. CHARACTERIZATION OF SMOOTH SURFACES

### A. Parameterization of Smooth Surfaces

A smooth surface  $\Gamma$  can be parameterized by a continuous  $\mathcal{C}^2$ -function  $\Phi$  of two variables  $\mathbf{q} = (u, v) \in \Omega$ :

$$\begin{aligned} \Phi : \Omega \subset \mathbb{R}^2 &\rightarrow \mathbb{R}^3 \\ (u, v) &\mapsto \mathbf{Q} = \begin{pmatrix} \Phi_x(u, v) \\ \Phi_y(u, v) \\ \Phi_z(u, v) \end{pmatrix} \end{aligned} \quad (1)$$

We do not make a distinction between the surface  $\Gamma$  and the mapping  $\Phi$  unless needed. The Jacobian matrix of  $\Phi$ , denoted  $\mathbf{J}_\Phi$ , is given by:

$$\mathbf{J}_\Phi = \begin{pmatrix} \frac{\partial \Phi_x}{\partial u} & \frac{\partial \Phi_x}{\partial v} \\ \frac{\partial \Phi_y}{\partial u} & \frac{\partial \Phi_y}{\partial v} \\ \frac{\partial \Phi_z}{\partial u} & \frac{\partial \Phi_z}{\partial v} \end{pmatrix} \quad (2)$$

It is a  $3 \times 2$  matrix which at each  $\mathbf{q} = (u, v) \in \Omega$  maps its neighborhood to the tangent plane of  $\Gamma$  at  $\Phi(u, v)$ . The first fundamental form  $\mathbf{I}_\Phi$  is defined as:

$$\mathbf{I}_\Phi = \mathbf{J}_\Phi^\top \mathbf{J}_\Phi \quad (3)$$

It is a  $2 \times 2$  matrix which locally maps distances from  $\Omega$  to  $\Gamma$ . The second fundamental form  $\mathbf{II}_\Phi$  characterizes the curvature at different locations on the surface. It is a second order form on the tangent plane defined as a  $2 \times 2$  matrix:

$$\mathbf{II}_\Phi = \begin{pmatrix} \Phi_{uu} \cdot \mathbf{N} & \Phi_{uv} \cdot \mathbf{N} \\ \Phi_{uv} \cdot \mathbf{N} & \Phi_{vv} \cdot \mathbf{N} \end{pmatrix} \quad (4)$$

where the dot stands for the scalar product.  $\mathbf{N}(u, v)$  is the vector normal to the surface at point  $\Phi(u, v)$  and:

$$\Phi_{uu} = \frac{\partial^2 \Phi}{\partial u^2}, \quad \Phi_{uv} = \frac{\partial^2 \Phi}{\partial u \partial v} \quad \text{and} \quad \Phi_{vv} = \frac{\partial^2 \Phi}{\partial v^2} \quad (5)$$

are 3-vectors.

### B. Classical Surface Mapping

We may distinguish between three classic mappings which do not change the surface topology: isometric, conformal, and equi-areal. If  $\Gamma$  is an isometric surface, then  $\mathbf{I}_\Phi$  is the identity. If  $\Gamma$  is conformal, *i.e.* angle preserving, then  $\mathbf{I}_\Phi$  is of the form:

$$\mathbf{I}_\Phi = \begin{pmatrix} \varphi & 0 \\ 0 & \varphi \end{pmatrix} \quad (6)$$

where  $\varphi : \Omega \rightarrow \mathbb{R}$  controls the amount of local isotropic scaling. If  $\Gamma$  is equi-areal, *i.e.* area preserving, then:

$$\det(\mathbf{I}_\Phi) = 1 \quad (7)$$

### C. Surface Deformation Measurements

When the surface is deformed from  $\Gamma$  to  $\Gamma'$  without changing its topology, the parameter space  $\Omega$  does not change while the surface function varies. Such a variation changes some geometric properties of the surface like the length of the geodesics, the area and the curvature. It is known from differential geometry that the first and second fundamental forms can be used to measure these deformations ([41]). For instance, given two surfaces  $\Gamma$  and  $\Gamma'$ , the Frobenius norm of the difference between the first fundamental forms of the two corresponding surface functions  $\Phi$  and  $\Phi'$ :

$$\mathcal{E}_e[\Phi'] = \int_{\Omega} \|\mathbf{I}_\Phi - \mathbf{I}_{\Phi'}\|_F^2 d\mathbf{q} \quad (8)$$

measures the extensibility of the geodesics between the two shapes. The norm of the difference between the second fundamental forms of these two deformations:

$$\mathcal{E}_b[\Phi'] = \int_{\Omega} \|\mathbf{II}_\Phi - \mathbf{II}_{\Phi'}\|_F^2 d\mathbf{q} \quad (9)$$

measures the change in curvature. Our variational formulation of the 3D reconstruction of quasi-conformal surfaces is based on these measures.

## VI. DEFORMABLE 3D SHAPE RECONSTRUCTION: A VARIATIONAL FORMULATION

### A. Problem Statement

Given the template surface function  $\Phi$ , our objective is to retrieve the current surface function  $\Phi'$  given a single image after deformation. Function  $\Phi'$  minimizes the norm of

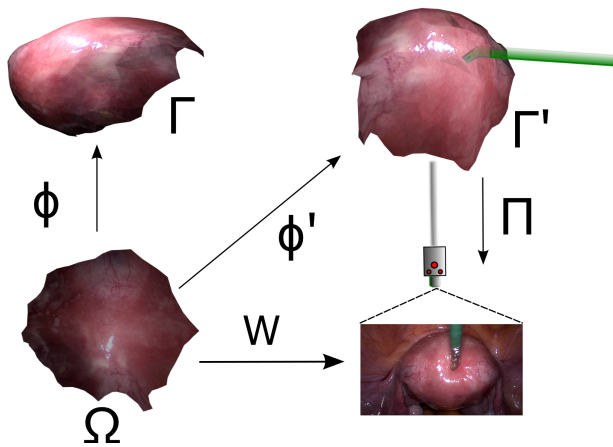

Fig. 3. Principle of the 3D reconstruction of a quasi-conformal surface.

the difference between the reprojected 3D points and their corresponding 2D points in the image (see figure 3 for a non-developable surface):

$$\mathcal{E}_d[\Phi'] = \int_{\Omega} \|\mathbf{K}\Pi(\Phi') - \mathcal{W}\|_2^2 d\mathbf{q} \quad (10)$$

where  $\mathbf{K}$  is the  $3 \times 3$  intrinsic matrix established in the exploration phase.  $\Pi: \mathbb{R}^3 \rightarrow \mathbb{R}^2: (x, y, z)^T \mapsto (\frac{x}{z}, \frac{y}{z})^T$  is the projection of a 3D point to the image plane.  $\mathcal{W}(u, v)$  establishes a continuous mapping between points of the template surface and their correspondences in the input image. In practice, such a function is replaced by a discrete set of  $N_c$  3D/2D point correspondences  $\{\Phi(u_i, v_i) \leftrightarrow (u'_i, v'_i)^T\}_{i=1, \dots, N_c}$ . Here  $(u'_i, v'_i)$  is the pixel position in the deformed image corresponding to the point  $\Phi(u_i, v_i)$ .

The formalization of the 3D reconstruction problem as the minimization of the functional (10) is under-constrained and we can obtain an infinite number of deformations as illustrated in figure (4). Depending on the nature of the surface, additional geometric priors are required. We use the surface's first and second fundamental forms. The 3D reconstruction problem can then be posed as a variational problem where the unknown is the functional  $\Phi'$ :

$$\min_{\Phi'} \mathcal{E}_d[\Phi'] + \lambda_e \mathcal{E}_e[\Phi'] + \lambda_b \mathcal{E}_b[\Phi'] \quad (11)$$

This is the sum of three terms. The first term is the data fidelity term. The second two terms are used to enforce deformation priors. We split this into two components; the term  $\mathcal{E}_b$  is used to penalise non-smooth bending of the surface. The term  $\mathcal{E}_e$  is used to penalize deformations which do not agree with the intrinsic material properties of the surface. In the research literature,  $\mathcal{E}_e$  has been instantiated previously using an isometric prior which associates higher energies to extensible deformations. Although not immediately applicable for extensible surfaces, a convex approximation to problem (11) has been formulated by [14] for inextensible surfaces. We review now this formulation in the next paragraph.

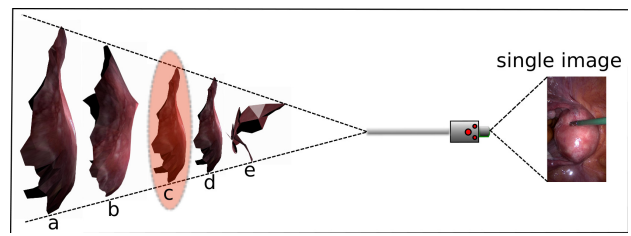

Fig. 4. Without prior, template-based monocular 3D reconstruction of a deformable surface is an ill-posed problem. All the shapes (a, b, c, d, e) project to the same correspondences in the deformed image. To retrieve the correct shape (c), additional constraints have to be added.

### B. Isometric Surfaces

It is known that isometric and developable surfaces such as paper can be isometrically flattened to the 2D plane without stretching (see figure 5). Consequently, a planar template can be used, and any 3D embedding of the surface must be isometric with respect to this plane. Now, because the first fundamental form of planar surfaces is the identity matrix  $\mathbf{1}$ , the 3D reconstruction problem can be written as:

$$\min_{\Phi'} \mathcal{E}_d[\Phi'] + \lambda_e \mathcal{E}'_e[\Phi'] + \lambda_b \mathcal{E}'_b[\Phi'] \quad (12)$$

where:

$$\mathcal{E}'_e[\Phi'] = \int_{\Omega} \|\mathbf{I}_{\Phi'} - \mathbf{1}\|_F^2 d\mathbf{q} \quad (13)$$

If  $\Phi$  is an isometry we can choose  $\Gamma \equiv \Omega$  then  $\Phi$  is the identity map. Thus the bending term (9) can be approximated by the second derivatives:

$$\mathcal{E}'_b[\Phi'] = \int_{\Omega} \|\Phi'_{uu}\| + \|\Phi'_{vv}\|_2^2 d\mathbf{q} \quad (14)$$

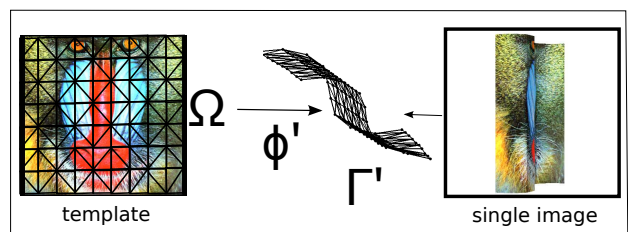

Fig. 5. 3D reconstruction of isometric surfaces.

### C. Quasi-Conformal Surfaces

Unlike isometric developable surfaces, a quasi-conformal surface cannot be flattened to a plane without inducing stretching or shrinking as shown in figure 3. Quasi-conformal surfaces include both extensible and non-developable surfaces. In the abdominal cavity, the organs are often extensible and non-developable surfaces: uterus, liver, kidneys, etc. For modeling the deformations of such organs, we could identify the mechanical properties of each of these different tissues. However, according to the patient (age, health of the organ, etc), the mechanical properties of the tissue would change. Our current

solution uses a differential geometry approach rather than mechanical models. For a quasi-conformal deformation  $\Phi'$ , our constrained variational formulation of the 3D reconstruction is stated as:

$$\min_{\Phi'} \mathcal{E}_d[\Phi'] + \lambda_c \mathcal{E}_c[\Phi'] + \lambda_a \mathcal{E}_a[\Phi'] + \lambda_b \mathcal{E}_b[\Phi'] \quad (15)$$

where:

$$\mathcal{E}_c[\Phi'] = \int_{\Omega} \left\| \mathbf{I}_{\Phi'} - \begin{pmatrix} \varphi & 0 \\ 0 & \varphi \end{pmatrix} \right\|_F^2 d\mathbf{q} \quad (16)$$

and:

$$\mathcal{E}_a[\Phi'] = \int_{\Omega} (\det(\mathbf{I}_{\Phi'}) - \det(\mathbf{I}_{\Phi}))^2 d\mathbf{q} \quad (17)$$

with  $\mathbf{I}_{\Phi} = \begin{pmatrix} \varphi & 0 \\ 0 & \varphi \end{pmatrix}$  and  $\varphi(u, v)$  is a real, positive scalar.  $\mathcal{E}_c$  softly constrains the 3D embedding to stretch or shrink isotropically. Since local isotropy implies that angles on the surface are preserved, this therefore penalises non-conformal embeddings. By contrast, in  $\mathcal{E}_a$  we softly enforce equal determinant of the first fundamental forms, and this constrains the area between template and deformed surfaces to be locally equal. The priors are weighted by  $\lambda_c$  and  $\lambda_a$  respectively. Consequently, by setting  $\lambda_c$  and  $\lambda_a$  accordingly, we can relax the isometry constraints and tolerate either angle or area changes. Crucially, we have found experimentally that changes in areas should be tolerated more than in angles, allowing the surface to locally-isotropically deform. The bending term is weighted with a small  $\lambda_b$  relatively to  $\lambda_c$  and  $\lambda_a$  to allow curvature changes and to obtain smooth 3D reconstructions. Problem (15) is non-convex and its resolution needs a descent initialization before minimization with a non-linear optimizer. In the next section, we describe how we resolve problem (15).

## VII. DISCRETE FORMULATION

### A. Initialization

This initialization step allows us to have a proper initial estimate of the deformed shape using an SOCP formulation in the case of quasi-conformal surfaces.

1) *Previous Approaches:* In the case of isometric surfaces several SOCP formulations have been proposed. These formulations rely on the principles that a 3D surface point  $\mathbf{Q}$  lies on the sightline linking its image projection  $(u', v')^T$  and the camera center. It is obvious that this constraint is enough to fit the image reprojection constraint but since it does not have any constraint on the surface shape these have to be supplied by other geometric constraints. A pointwise SOCP formulation for isometric surfaces was proposed by [14]. It is based on the observation that the euclidean distance between two surface points  $\mathbf{Q}_i$  and  $\mathbf{Q}_j$  cannot be greater than the geodesic distance  $d_{ij}$  for any possible isometric deformations (see figure 6). The geodesic distances can be easily computed as the euclidean distances of the isometrically flattened template. The

formulation is stated as:

$$\begin{aligned} & \max_{\mathbf{Q}_1, \dots, \mathbf{Q}_{N_c}} \mathbf{p}_3^T \sum_{i=1}^{N_c} \mathbf{Q}_i, & \text{(max. depth)} \\ & \text{s.t.} \\ & \left\| \begin{pmatrix} \mathbf{p}_1^T \\ \mathbf{p}_2^T \end{pmatrix} \mathbf{Q}_i - \mathbf{q}'_i \mathbf{p}_3^T \mathbf{Q}_i \right\|_2 \leq \epsilon_{\mathcal{I}} \mathbf{p}_3^T \mathbf{Q}_i, & \text{(img. err.)} \\ & \|\mathbf{Q}_i - \mathbf{Q}_j\|_2 \leq d_{ij} + \epsilon_{\tau}, & \text{(isometry)} \\ & \mathbf{p}_3^T \mathbf{Q}_i \geq 0, & \text{(positive depth)} \end{aligned} \quad (18)$$

where  $\mathbf{p}_k$  is the  $k^{\text{th}}$  row of the known matrix  $\mathbf{K}$ . The

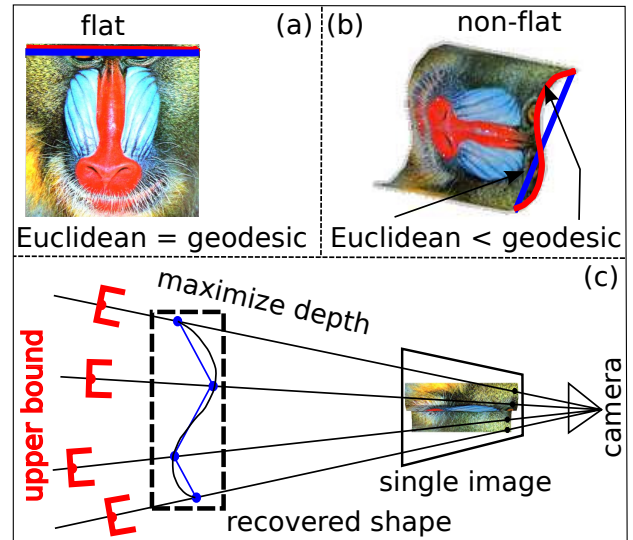

Fig. 6. 3D reconstruction using SOCP with isometric formulation. (a) In a flat shape, the Euclidean distance is equal to the geodesic distance. (b) In a non-flat shape of an isometric surface, the Euclidean distance is lower than the geodesic distance. (c) This last observation allows one to put an upper bound constraint when the depth is maximized.

maximization of the depth is controlled by the euclidean distance between the 3D points which cannot be greater than the corresponding geodesic.  $\epsilon_{\mathcal{I}}$  and  $\epsilon_{\tau}$  are small real values which model the tolerance to noise in the correspondences and in the template. An SOCP formulation for isometric surfaces with mesh representation is proposed by [26]. The reconstruction of one frame relies on the reconstructed mesh of the preceding frame. For the first frame, the initial pose of the mesh is assumed to be known and a failure in one frame can cause failures to chain over the video.

2) *Our Formulation Using SOCP:* In our work, the previously described formulations with SOCP cannot be directly used since they are not designed for quasi-conformal surfaces (see figure 7). Indeed, they cannot handle non-developable and extensible surfaces.

Let us denote  $\mathbf{V}'$  the set of vertices of the mesh of the deformed surface  $\Gamma'$ . In our work, the 3D-2D correspondences between points  $\mathbf{x}_i$ ,  $i = 1, \dots, N_c$  in the template mesh and points  $(u'_i, v'_i)^T$ ,  $i = 1, \dots, N_c$  in the deformed image are assumed to be known. In the triangular mesh they are

expressed in barycentric coordinates:

$$\mathbf{x}_i = a_i \mathbf{v}_{j,1} + b_i \mathbf{v}_{j,2} + c_i \mathbf{v}_{j,3} \in \Gamma, i = 1 \dots N_c \quad (19)$$

with  $a_i, b_i, c_i \in [0, 1]$  and  $\mathbf{v}_{j,1}, \mathbf{v}_{j,2}$  and  $\mathbf{v}_{j,3}$  are vertices of the face  $f_j$ . Our first SOCP formulation of the 3D reconstruction of the deformed mesh can be stated as follows:

$$\begin{aligned} & \max_{\mathbf{V}'} \mathbf{p}_3^\top \sum_{i=1}^{N_c} \mathbf{x}'_i, & \text{(max. depth)} \\ & \text{s.t.} \\ & \left\| \begin{pmatrix} (\mathbf{p}_1 - u_i \mathbf{p}_3) \mathbf{x}'_i \\ (\mathbf{p}_2 - v_i \mathbf{p}_3) \mathbf{x}'_i \end{pmatrix} \right\|_2 \leq \epsilon_{\mathcal{I}} \mathbf{p}_3 \mathbf{x}'_i, & \text{(img. err.)} \quad (20) \\ & \|\mathbf{v}'_i - \mathbf{v}'_j\|_2 \leq \kappa \|\mathbf{v}_i - \mathbf{v}_j\|_2 + \epsilon_\tau, & \text{(extension)} \end{aligned}$$

where  $\mathbf{x}'_i$  is the new location of the 3D correspondence point in the deformed mesh.  $\kappa$  is a real parameter chosen so that edges are able to shrink or to stretch. As expected, when the depth is maximized and the vertices move toward the correct sightline, the global shape of the surface can be corrupted since the edges are allowed to extend or to shrink. To avoid obtaining meaningless 3D reconstructions, a smoothing term based on a discrete laplacian is added. It ensures a global resemblance between the deformed surface and the template surface. Moreover, this smoothing term preserves the shape in occluded areas. Indeed, in non-developable surfaces like the uterus, it is mandatory to be able to handle occlusions since it is not possible to have a single view which covers the whole surface.

In the discrete differential geometry of 2-manifolds, there are various formulations of the discrete Laplace-Beltrami operator as described by [42]. The one we use in our implementation is the linear combinatorial formulation expressed as:

$$\mathbf{l}_i = \mathcal{L}(\mathbf{v}_i) = \mathbf{v}_i - \frac{1}{\#\mathcal{N}(i)} \sum_{j \in \mathcal{N}(i)} \mathbf{v}_j \quad (21)$$

with  $\mathcal{N}(i)$  the one ring neighbor of vertex  $i$  and  $\#\mathcal{N}(i)$  is the cardinal of this set. The norm of  $\mathbf{l}_i$  represents the discrete approximation of the mean curvature at vertex  $\mathbf{v}_i$  [42]. Allowing smooth changes of the norm of this vector over the mesh vertices allows us to keep the global shape of the surface. Then, an additional constraint can be added in our formulation of equation (20):

$$\begin{aligned} & \max_{\mathbf{V}'} \mathbf{p}_3^\top \sum_{i=1}^{N_c} \mathbf{x}'_i, & \text{(max. depth)} \\ & \text{s.t.} \\ & \left\| \begin{pmatrix} (\mathbf{p}_1 - u_i \mathbf{p}_3) \mathbf{x}'_i \\ (\mathbf{p}_2 - v_i \mathbf{p}_3) \mathbf{x}'_i \end{pmatrix} \right\|_2 \leq \epsilon_{\mathcal{I}} \mathbf{p}_3 \mathbf{x}'_i, & \text{(img. err.)} \\ & \|\mathbf{v}'_i - \mathbf{v}'_j\|_2 \leq \kappa \|\mathbf{v}_i - \mathbf{v}_j\|_2 + \epsilon_\tau, & \text{(extension)} \\ & \|\mathbf{l}'_i\|_2 \leq \kappa_s \|\mathbf{l}_i\|_2 & \text{(shape smoother)} \end{aligned} \quad (22)$$

with  $\kappa_s$  a positive value which controls the tolerance to curvature change. In our implementation we use the *YALMIP*-toolbox ([43]) to compute the solution of our SOCP formulation with  $\kappa_s = 0.1$ . Even if problem (20) is convex, its solution is not optimal mainly because in practice the correspondences

never cover densely the template surface. The refinement is done by using a discrete version of the variational formulation of equation (15).

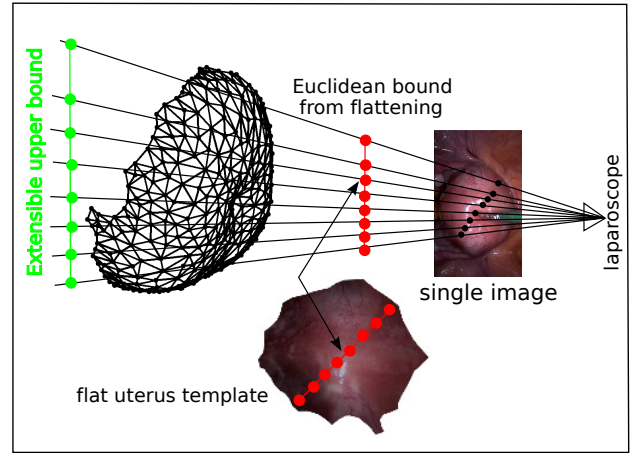

Fig. 7. 3D reconstruction using SOCP with extensible formulation. It is obvious that the Euclidean distance from the flat shape cannot be used in the case of quasi-conformal surfaces. Instead we use an upper bound of extended template edge lengths. Further constraints on curvature preserving are added to keep a meaningful reconstructed shape.

### B. Refinement

In our formulation of equation (15), the local non-isometry constraint is expressed as the sum of a local isotropy constraint and a local equi-areal constraint. The weights associated to each constraint allow us to penalize either the angle variation or the area variation of a local region during the deformation. Equivalently, using a triangular mesh representation of the surface, each triangle can be subject to shearing and anisotropy scaling for any quasi-conformal deformation. Henceforth, equation (15) can be re-formalized for a triangular mesh surface as:

$$\begin{aligned} & \min_{\mathbf{V}'} \sum_{i=1}^{N_c} \left\| \begin{pmatrix} (\mathbf{p}_1 - u_i \mathbf{p}_3) \mathbf{x}'_i \\ (\mathbf{p}_2 - v_i \mathbf{p}_3) \mathbf{x}'_i \end{pmatrix} \right\| & \text{(motion)} \\ & + \lambda_{sh} \sum_{i=1}^{N_f} \|S_i - S_i^0\|^2 & \text{(shearing)} \quad (23) \\ & + \lambda_{an} \sum_{i=1}^{N_f} \|A_i - A_i^0\|^2 & \text{(anisotropy)} \\ & + \lambda_s \|\mathcal{L}(\mathbf{l}_i)\|^2 & \text{(smoothing)} \end{aligned}$$

$S_i$  and  $A_i$  are the 2D shearing and anisotropy scaling transforms from the template to the deformed  $i^{\text{th}}$  face,  $\lambda_{an}$  and  $\lambda_{sh}$  are two real positive weights that tune the amount of penalty for shearing, anisotropy scaling, and the smoothing energy term. The inextensible formulation enforces the edges of the triangles to remain constant when fitting the data correspondences. In contrast, this weighted combination of quasi-conformal transforms relaxes the inextensible condition and allows us to deal with local extensible deformations.  $S^0$  and  $A^0$  are local maximum amounts of shearing and anisotropy scaling for each face of the 3D template mesh. They can be either learned from training data or experimentally set. Practically, normalized shearing and anisotropy scaling



transforms are experimentally set and then scaled by the triangle area of each face  $f_i$  to obtain the transforms  $S_i^0$  and  $A_i^0$ . In all our experiments we set  $S_i^0 = \begin{pmatrix} 1.05 & 0 \\ 0 & 1.05 \end{pmatrix}$  and  $A_i^0 = \begin{pmatrix} 1 & 0.1 \\ 0 & 1 \end{pmatrix}$  to tolerate fair scaling and shearing for each triangle of the mesh. The additional weighted energy term smoothes the deformed shape with a tunable weight  $\lambda_s$ . It is expressed through the linear Laplace-Beltrami discrete linear operator  $\Delta$  of dimension  $N \times N$  ([44]). The weights  $\lambda_{an}$ ,  $\lambda_{sh}$  and  $\lambda_s$  are respectively set to 0.11, 0.14 and 0.12 using the method described by [45]. They hardly enforce the motion term to fit the correspondence constraint and fairly constrain the shearing, the anisotropy scaling and the smoothness to allow the triangle to freely deform.

## VIII. EXPERIMENTAL RESULTS

### A. In-Vivo Data With Ground-Truth

To obtain in-vivo datasets with ground-truth we use two synchronized laparoscopes to explore and deform the abdominal cavity of a living pig. The experiment is done in the Centre International de Chirurgie Endoscopique (CICE<sup>1</sup>) under respect of ethical constraints. We used two synchronised laparoscopes to construct ground-truth for metric comparison. To cope with the difficulty of having a non-constant rigid transforms between the two laparoscopes we put a reference checker-board inside the abdominal cavity. This checker-board allows us at any frame to register the left and right views to obtain ground-truth 3D information. In the first exploratory step we reconstruct the 3D template of three different organ's tissues: the bladder and the pericardium. The obtained shapes are shown in figure 9. In the deformation step, the bladder and the pericardium are deformed with the checker-board tool. A set of 100 deformed image frames are taken for each tissue. For our reconstruction method we use on average a set of 40, 25 and 30 point correspondences respectively for the bladder and the pericardium. They were generated using SIFT ([46]). Outliers and points outside from the organs in concern were removed by the method proposed in ([47]). In figure 10 we show a subset of different 3D reconstructions using our method from single views for different amounts of extensibility and curvature change with respect to the templates. We can see that globally our method gives meaningful 3D reconstructions according to the deformed images. Note that the features on the deformed regions with the quasi-conformal constraint give consistent recovery of the deformation. These observations are confirmed quantitatively in figure I where we show the reconstruction errors with respect to stereo and with comparison to isometric reconstruction. The reconstruction errors are computed with all the sets of images as the norm of the difference between the stereo 3D points and the reconstructed 3D points of each organ's tissue. Our method gives an order

<sup>1</sup><http://www.cice.fr/>

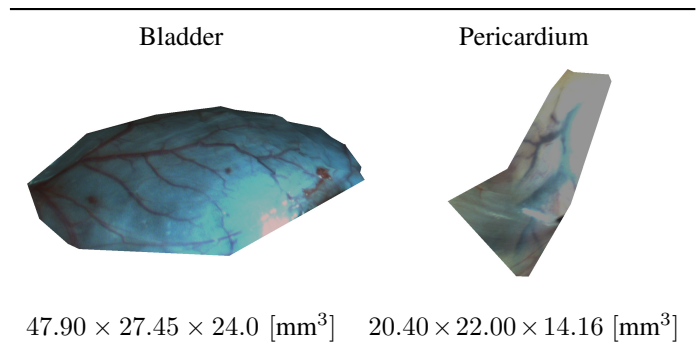

Fig. 9. Pig datasets: 3D templates of three different organ's tissues: The bladder and the pericardium. For each template we indicate in mm the size of the box bounding the 3D shape.

	Quasi-Conformal	Isometric
Bladder		
Median	2.61	6.25
Min	1.72	5.20
Max	3.10	6.62
Pericardium		
Median	2.20	5.25
Min	1.56	3.03
Max	3.79	6.52

TABLE I  
DETAILED QUANTITATIVE RESULTS FOR DIFFERENT IN-VIVO TISSUES.  
THE ERRORS ARE IN MILLIMETERS.

of magnitude more accurate with an average of 5mm error on the 3D reconstruction.

### B. Surgery In-Vivo Data

To validate the proposed approach on real in-vivo data, the experiment we propose is the 3D reconstruction of an uterus from in-vivo sequences acquired using a monocular Karl Storz laparoscope. The frames are acquired at 30 fps and have a resolution of  $1280 \times 720$ . The 3D template of the uterus is generated during the laparosurgery exploration step as previously described. Complex and unpredictable deformations may occur on the uterus when the surgeon starts to examine it. A set of 75 correspondences between the flattened uterus template and the deformed images were used. They were generated using SIFT ([46]). Outliers and points outside from the uterus region were removed by the method proposed in ([47]) (table 11, row 2). In figure 11, rows 3-4, we show the 3D reconstructed deformations with the corresponding deformed image in row 1. In row 4, we show synthesized views from novel camera views, and show qualitatively that the deformed uterus has been reconstructed well.

### C. Discussion

Our experimental results have shown the effectiveness and the improvement of our approach above a previous method proposed by [14] relying also on a single view and a template (c.f. table I for quantitative comparison). State-of-the-

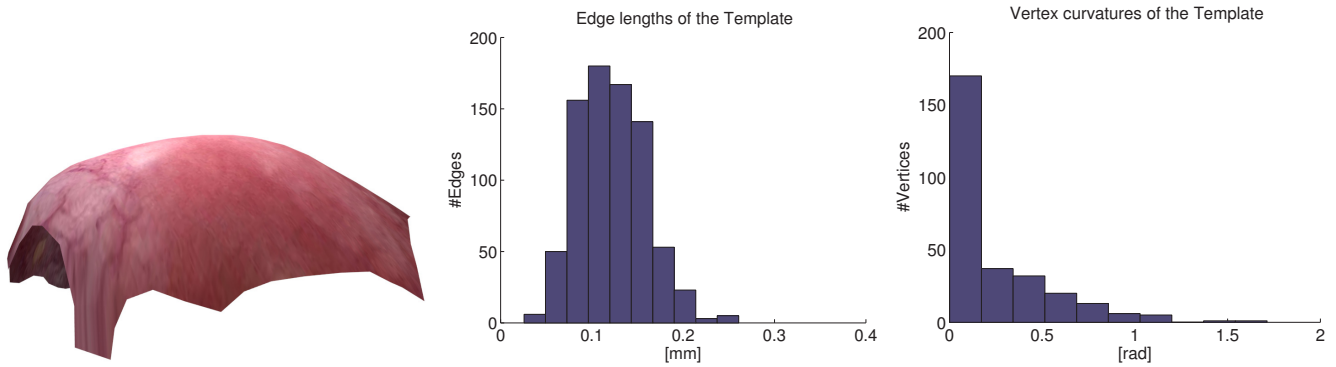

Fig. 8. Shape and geometric measures of the 3D template surface. Left: texture-mapped 3D template surface. Middle: the length of the edges. Right: the conformal curvatures, in radians, computed at each vertex of the mesh ([42]).

Rate of deformation	Left image	Right image	Correspondences between template and right image	3D reconstruction with our method from right image
ext 15%				
cur 10%				
ext 18%				
cur 12%				
ext 10%				
cur 5%				
ext 12%				
cur 7%				

Fig. 10. In-vivo pig datasets: 3D reconstruction from a monocular laparoscope using our quasi-conformal method. First column: Rate of deformation in extensibility and curvature change with respect to the 3D template. Second column: Left image from stereo view used to compute ground-truth deformation. Third column: Right image from stereo view. This image is used together with the left image to generate ground-truth 3D reconstruction. It is also used as single image to obtain 3D reconstruction with our method. Third column: correspondences between template image and right image used for the 3D reconstruction with our method. Fourth column: 3D reconstruction with our method from single image. Quantitative 3D errors of reconstruction are shown in table I.

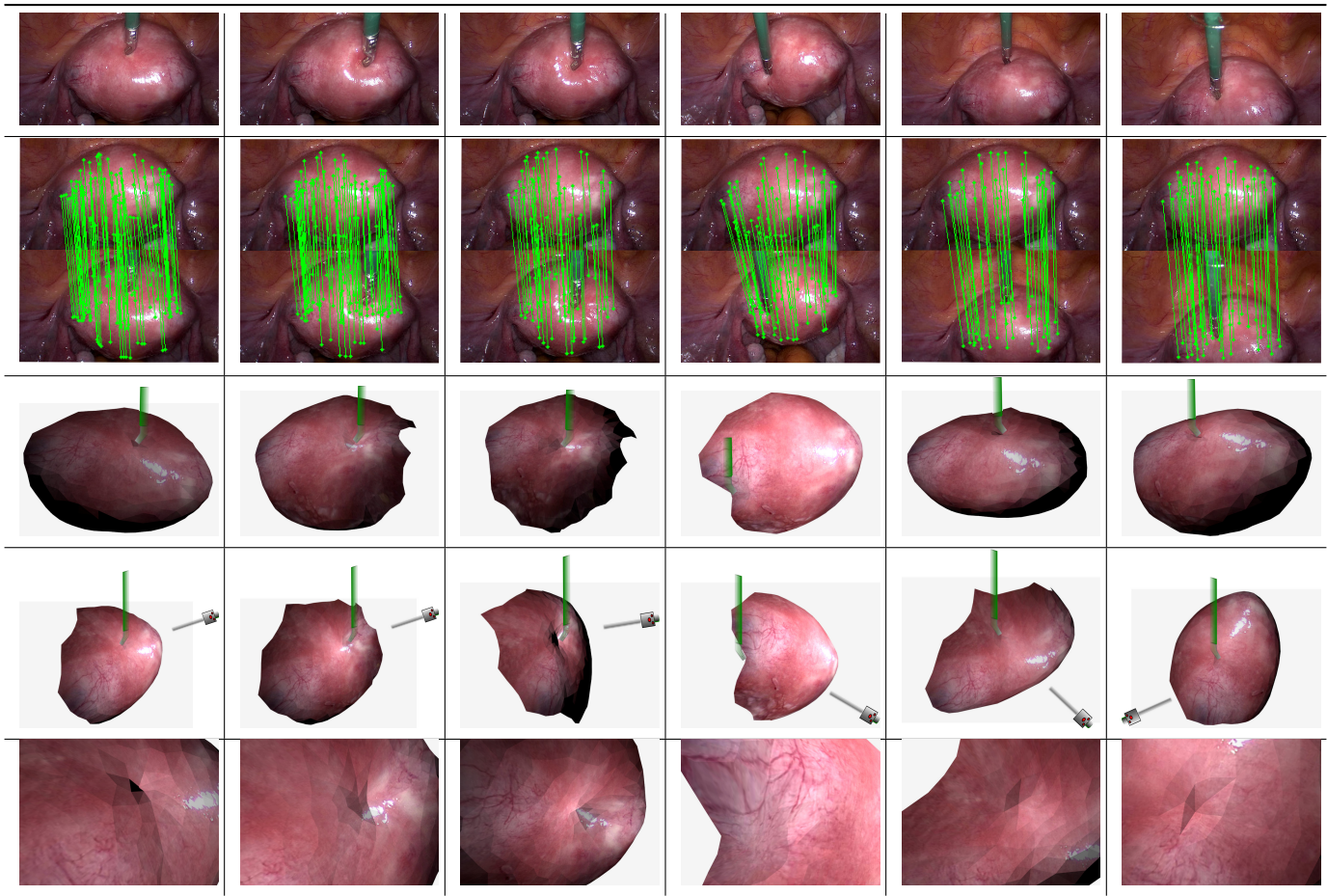

Fig. 11. 3D reconstruction on an in-vivo video sequence from a monocular laparoscope using our quasi-conformal method. First row: Single 2D views of uterus deformation with a surgery tool. Second row: Point correspondences between the template and deformed images. Third row: 3D reconstruction using our quasi-conformal method. Each 3D reconstruction is done using the single view above. The view is given in the laparoscope's view point. Fourth row: 3D deformed surface seen from a different point of view which provides visualization of the self-occluded part. Fifth row: Zoom in the deformed area.

art NRSfM methods for non-isometric deformations are only sequential for soft or cyclic deformations relying on deformed shapes at precedent time of the current deformed frame. Our approach relies on a template which can be more accurately recovered before starting to reconstruct deformed shapes. Moreover, it uses only a single image and thus does not rely on any temporal priors.

### IX. CONCLUSION

In this paper, we have presented a new method to reconstruct a quasi-conformal deforming living tissue in 3D using a single laparoscopic image and a 3D template that is previously reconstructed using standard RSfM. Our method provides novel technical contributions and also a new way of tackling the 3D vision problem in laparoscopy. The experimental results show the effectiveness of our approach and clearly improve the state-of-the-art isometric reconstruction method.

The performance of our 3D reconstruction algorithm depends on the point correspondences between the template and the deformed image. When the tracking system may miss some features our approach can be joined together with shading approach in order to recover the 3D shape of those featureless

regions. We are currently working on improving the matching between the template and deformed image and supplying our approach with shading cues in featureless regions. Finally, it would be interesting to investigate a mechanical modeling approach in future work.

### APPENDIX

Percentage of deformation with respect to extensibility:

$$ext = \frac{\sum_{i=1}^{N_e} \left| \| \mathbf{e}'_i \| - \| \mathbf{e}_i^0 \| \right|}{\sum_{i=1}^{N_e} \| \mathbf{e}_i^0 \|} \times 100,$$

where  $\{\mathbf{e}'_i\}_{i=1, \dots, N_e}$  is the set of edges of the deformed mesh and  $\{\mathbf{e}_i^0\}_{i=1, \dots, N_e}$  is the set of edges of the template mesh. Percentage of deformation with respect to curvature change:

$$cur = \frac{\sum_{i=1}^{N_e} \| \mathbf{l}'_i - \mathbf{l}_i^0 \|}{\sum_{i=1}^{N_e} \| \mathbf{l}_i^0 \|} \times 100,$$

where  $\{\mathbf{l}'_i\}_{i=1, \dots, N}$  is the set of curvatures of the deformed mesh and  $\{\mathbf{l}_i^0\}_{i=1, \dots, N}$  is the set of curvatures of the template mesh. In order to evaluate the performance of our approach,



we use the following error measure in mm:

$$\sqrt{\frac{\sum_{i=1}^{N_v} \|\mathbf{v}'_i - \mathbf{v}_i\|^2}{N_v}},$$

where  $\{\mathbf{v}'_i\}_{i=1,\dots,N_v}$  are the vertices of the 3D reconstructed mesh and  $\{\mathbf{v}_i\}_{i=1,\dots,N_v}$  are the vertices of the deformed mesh.

## REFERENCES

- [1] S. Nicolau, X. Pennec, L. Soler, and N. Ayache, "A complete augmented reality guidance system for liver punctures: First clinical evaluation," in *MICCAI*, 2005.
- [2] M. Hayashibe, N. Suzuki, and Y. Nakamura, "Intraoperative fast 3d shape recovery of abdominal organs in laparoscopy," in *MICCAI*, 2002.
- [3] —, "Laser-scan endoscope system for intraoperative geometry acquisition and surgical robot safety management." *Medical Image Analysis*, vol. 10, pp. 509–519, 2006.
- [4] J. Penne, K. Hiller, M. Strmer, T. Schrauder, A. Schneider, R. Engelbrecht, H. Feubner, B. Schmauss, and J. Hornegger, "Time-of-flight 3-d endoscopy," in *MICCAI*, 2009.
- [5] M. Winter, "Image-based incremental reconstruction, rendering and augmented visualization of surfaces for endoscopic surgery," Ph.D. dissertation, University of Erlangen, 2009.
- [6] P. Moutney, D. Stoyanov, A. Davison, and G. Yang, "Simultaneous stereoscope localization and soft-tissue mapping for minimal invasive surgery," in *MICCAI*, 2006.
- [7] G. Hager, B. Vagvolgyi, and D. Yuh, "Stereoscopic video overlay with deformable registration," in *Medicine Meets Virtual Reality*, 2007.
- [8] D. Stoyanov, M. V. Scarzanella, P. Pratt, and G.-Z. Yang, "Real-time stereo reconstruction in robotically assisted minimally invasive surgery," in *MICCAI*, 2010.
- [9] J. Totz, P. Moutney, , and D. S. G. Yang, "Dense surface reconstruction for enhanced navigation in mis," in *MICCAI*, 2011, pp. 89–96.
- [10] O. G. Grasa, J. Civera, and J. Montiel, "EKF monocular slam with relocalization for laparoscopic sequences," in *International Conference on Robotics and Automation*, 2011.
- [11] T. Collins, B. Compte, and A. Bartoli, "Deformable shape-from-motion in laparoscopy using a rigid sliding window," in *Proc. of Medical Image Understanding and Analysis (MIUA'11)*, 2011.
- [12] M. Hu, P. Penney, D. Rueckert, P. Edwards, F. Bello, R. Casula, M. Figl, and D. Hawkes, "Non-rigid reconstruction of the beating heart surface for minimally invasive cardiac surgery," in *MICCAI*, 2009.
- [13] P. Moutney and G. Yang, "Motion compensated slam for image guided surgery," in *MICCAI*, 2010.
- [14] F. Brunet, R. Hartley, A. Bartoli, N. Navab, and R. Malgouyres, "Monocular template-based reconstruction of smooth and inextensible surfaces," in *ACCV*, 2010.
- [15] M. Perriollat, R. Hartley, and A. Bartoli, "Monocular template-based reconstruction of inextensible surfaces," in *BMVC*, 2008.
- [16] M. Salzmann, R. Hartley, and P. Fua, "Convex optimization for deformable surface 3-D tracking," in *ICCV*, 2007.
- [17] A. Malti, A. Bartoli, and T. Collins, "Template-based conformal shape-from-motion from registered laparoscopic images," in *MIUA*, 2011.
- [18] V. Blanz and T. Vetter, "A morphable model for the synthesis of 3D faces," in *SIGGRAPH*, 1999.
- [19] T. F. Cootes, G. J. Edwards, and C. J. Taylor, "Active appearance models," in *ECCV*, 1998.
- [20] I. Matthews and S. Baker, "Active appearance models revisited," *International Journal of Computer Vision*, vol. 60, no. 2, pp. 135–164, November 2004.
- [21] M. Salzmann, J. Pilet, S. Ilic, and P. Fua, "Surface deformation models for nonrigid 3D shape recovery," *IEEE PAMI*, vol. 29, no. 8, pp. 1–7, August 2007.
- [22] F. Moreno-Noguer, M. Salzmann, V. Lepetit, and P. Fua, "Capturing 3D stretchable surfaces from single images in closed form," in *CVPR*, 2009.
- [23] F. Moreno-Noguer and J. Porta, "Probabilistic simultaneous pose and non-rigid shape recovery," in *CVPR*, 2011.
- [24] R. Urtaun, D. Fleet, A. Hertzman, and P. Fua, "Priors for people tracking from small training sets," *ICCV*, 2005.
- [25] R. Navaratnam, A. W. Fitzgibbon, and R. Cipolla, "The joint manifold model for semi-supervised multi-valued regression," in *ICCV*, 2007.
- [26] M. Salzmann and P. Fua, "Linear local models for monocular reconstruction of deformable surfaces," *IEEE Transactions on Pattern Analysis and Machine Intelligence*, pp. 931–944, 2011.
- [27] C. Bregler, A. Hertzmann, and H. Biermann, "Recovering non-rigid 3D shape from image streams," in *CVPR*, 2000.
- [28] L. Torresani, A. Hertzmann, and C. Bregler, "Learning non-rigid 3D shape from 2D motion," in *Neural Information Processing Systems Conference*, 2003.
- [29] J. Xiao and T. Kanade, "Uncalibrated perspective reconstruction of deformable structures," in *ICCV*, 2005.
- [30] D. Terzopoulos, A. Witkin, and M. Kass, "Constraints on deformable models: Recovering 3D shape and nonrigid motion," *Artificial Intelligence*, vol. 36, pp. 91–123, 1988.
- [31] L. D. Cohen and I. Cohen, "Finite-element methods for active contour models and balloons for 2-d and 3-d images," *IEEE PAMI*, vol. 15, no. 11, pp. 1131–1147, 1993.
- [32] D. Metaxas, *Physics based deformable models, applications to computer vision, graphics and medical imaging*. Kluwer International Series in Engineering and Computer Science, 1997.
- [33] A. Bartoli, V. Gay-Bellile, U. Castellani, J. Peyras, S. Olsen, and P. Sayd, "Coarse-to-fine low-rank structure-from-motion," in *CVPR*, 2008.
- [34] R. I. Hartley and A. Zisserman, *Multiple View Geometry in Computer Vision*. Cambridge University Press, 2003, second Edition.
- [35] A. Sheffer, B. Lvy, M. Mogilnitsky, and A. Bogomyakov, "Abf++: fast and robust angle based flattening," *ACM TRANSACTIONS ON GRAPHICS*, vol. 24, pp. 311–330, 2005.
- [36] G. Zou, J. Hu, X. Gu, and J. Hua, "Area-preserving surface flattening using lie advection," in *MICCAI*, 2011.
- [37] J. Shi and C. Tomasi, "Good features to track," in *CVPR*, 1994.
- [38] D. Forsyth and J. Ponce, *Computer Vision – A Modern Approach*. Prentice Hall, 2003.
- [39] O. Faugeras, Q.-T. Luong, and T. Papadopoulos, *The Geometry of Multiple Images*. MIT Press, March 2001.
- [40] D. Levin, "Mesh-independent surface interpolation," *Geometric Modeling for Scientific Visualization*, vol. 3, pp. 37–49, 2003.
- [41] M. Kass, A. Witkin, and D. Terzopoulos, "Snakes: Active contour models," *International Journal of Computer Vision*, vol. 1, no. 4, pp. 321–331, January 1988.
- [42] M. Meyer, M. Desbrun, P. Schröder, and A. H. Barr, "Discrete differential-geometry operators for triangulated 2-manifolds," in *Visualization and Mathematics III*. Springer-Verlag, 2003, pp. 35–57.
- [43] J. Lofberg, "Yalmip : A toolbox for modeling and optimization in MATLAB," in *Proceedings of the CACSD Conference*, 2004.
- [44] D. Yoo, "Three-dimensional morphing of similar shapes using a template mesh," *International Journal of Precision Engineering and Manufacturing*, 2009.
- [45] B. Compte, A. Bartoli, and D. Pizarro, "Constant flow sampling: A method to automatically select the regularization parameter in image registration," in *Fifth Workshop on Biomedical Image Registration*, 2012.
- [46] D. G. Lowe, "Distinctive image features from scale-invariant keypoints," *International Journal of Computer Vision*, vol. 60, no. 2, pp. 91–110, 2004.
- [47] P. F. Alcantarilla and A. Bartoli, "Deformable 3d reconstruction with an object database," in *BMVC*, To appear.

# Mobile Web Services: State of the Art and Challenges

Khalid Elgazzar, Patrick Martin, Hossam Hassanein School of Computing, Queen's University, Canada  
Kingston, Ontario, K7L 3N6  
email{elgazzar, martin, hossam}@cs.queensu.ca

**Abstract**—For many years mobile devices were commonly recognized as Web consumers. However, the advancements in mobile device manufacturing, coupled with the latest achievements in wireless communication developments are both key enablers for shifting the role of mobile devices from service consumers to service providers. This paradigm shift is a major step towards the realization of pervasive and ubiquitous computing. Mobile Web service provisioning is the art of hosting and offering Web services from mobile devices, which actively contributes towards the direction of Mobile Internet. In this paper, we provide the state of the art of mobile service provisioning as it currently stands. We focus our discussions on its applicability, reliability, and challenges of mobile environments and resource constraints. We study the different provisioning architectures, enabler technologies, publishing and discovery mechanisms, and maintenance of up-to-date service registries. We point out the major open research issues in each provisioning aspect. Performance issues due to the resource constraints of mobile devices are also discussed.

**Index Terms**—Mobile Web services, service provisioning, mobile devices, ubiquitous computing, mobile computing.

## I. INTRODUCTION

Mobile devices (such as smartphones and PDAs) are traditionally recognized as resource-limited devices. Designers of mobile applications take these resource constraints into account in order to improve the performance of applications. While this is true, the manufacturers of mobile devices have recently achieved breakthroughs in extending mobile devices' capabilities in terms of memory, computational power, storage capacity, and display screen. In addition, many devices such as built-in cameras, infrared ports, bluetooth technology, and a large variety of sensors are embedded within the devices to expand their capabilities and functionalities. It is quite common now to see a single mobile device that can offer navigation information, measure ambient temperatures, control home devices such as TVs and air conditioners, be used as a wireless presentation remote control, and even perform fingerprint secured transactions.

In parallel, the revolution in wireless communications achieved astonishing developments in increasing transmission rates and improving the spectral efficiency. The 4G network introduces a flexible and programmable platform to provide users access to future services and applications from a single terminal. Cellular networks are able to accommodate more users and offer a wide range of customized services with various quality of service (QoS) levels. New services are increasingly offered to mobile users, capitalizing on the ever-

expanding mobile customer base. According to the latest Mobile FactBook released by PortioResearch [1], the global mobile customer base exceeded 6.5 billion subscribers in the beginning of 2013, which represents 87% of the world's current population. Additionally, 1.5 billion of those subscribers have broadband access to Internet services. Mobile users are always demanding better user experience and service personalization that can fit their dynamic context change and accommodate their preferences. The demand for such smart services that can fully utilize the user's mobility and remove barriers between network technologies is on the rise.

With the advancements in mobile devices' capabilities on one hand and the revolutionary achievements in wireless communications on the other hand, the global interest of mobile applications are on the rise. Consequently, researchers and industry are inspired to pave the road for mobile Web service provisioning [2], [3], [4], [5], [6], [7], [8].

The role of mobile devices as a Web service consumer is fundamental. Shifting the role of mobile devices from Web service clients to providers is feasible only if they can offer standard Web services with acceptable performance and with no impact on the regular use of mobile devices. In this paper, we describe the state-of-the-art of mobile Web service provisioning, address its applicability and reliability, point out the research efforts, and explore the challenges and open research problems. Throughout the remainder of this paper, we refer to mobile Web service provisioning as mobile services.

The remainder of this paper is organized as follows. Section II gives a brief background on the Web services approach. Section III discusses the current and potential applications that benefit from mobile services provisioning. Section IV presents different architectures for providing Web services from mobile devices. Section V explores various publishing and discovery techniques of mobile Web services. Section VI discusses the performance of mobile services provisioning. Section VII concludes the paper and outlines future research directions.

## II. WEB SERVICES

Service-oriented Architecture (SOA) has become a driving force for Web applications development. SOA uses services as the basic constructs to support rapid, low-cost, and easy composition of distributed applications even in heterogeneous environments [9]. In SOA, a service is defined by a Web interface that supports interoperable operations between dif-

ferent software applications using a standard messaging protocol [10]. In the early nineties, SOA offered the promise of robustness and agility to business enterprises to perform their business efficiently by supporting software reuse, application-to-application interoperability, design flexibility, and a loosely coupled architecture. Web services are the most popular implementation of SOA.

A Web service is a computational software entity which is able to achieve a user's objective by a remote invocation. Web services allow applications written in different programming languages to interact seamlessly through standard protocols [11]. A service, in contrast, is the actual value provided by the service invocation [12]. Web services have a wide scope of applications ranging from simple stock quotes to very complex applications such as Internet banking, weather forecasts, map services. Figure 1 depicts a breakdown of the Web services approach in terms of design style, interface and functionalities description, and type categorization.

#### A. Web Service Design

Web services enable *software as a service* to deliver software services over the network using technologies such as XML. Web services that comply with SOA architecture and use the SOAP protocol to communicate between the client interface and provider are called SOAP-based Web services. In 2000, Fielding [13] proposed a new architecture style for network-based applications called "*REpresentational State Transfer (REST)*". REST aimed at the generalization of interfaces, scalability of interactions, and independent deployments of software components. Web services built on top of REST principles are called RESTful Web services. The next two subsections shed light on these two architectural approaches with a comprehensive comparison between them.

1) *SOAP-based*: SOAP-based Web services are designed to allow RPC-like interactions with remote systems. In this design style the service provider and potential consumers need to establish a common understanding of the service syntax and the operations it offers. Each SOAP-based Web service has its own unique interface and is described by means of the Web Services Description Language (WSDL) [14], and that description is published in a public Universal Description Discovery and Integration (UDDI) registry. The UDDI manages and maintains these Web services' entries and keeps a reference for the Web service description file (WSDL document). XML is used to construct the basic blocks of Web service communication by means of some form of XML messaging protocol, such as SOAP (Simple Object Access Protocol) or XML-RPC (XML-Remote Procedure Call). SOAP-based Web services expose only a single endpoint, by which users communicate with offered functionality.

The strength of SOAP messaging protocol comes from its ability to work in heterogeneous environments and independently of the underlying platform. For example, SOAP handles the heterogeneity in data types across different platforms using XML Schemas to define primitive data types. Each system or platform maps these types to their internal data types. SOAP has a rigid type checking mechanism, by which

SOAP performs most of the standard data verifications. SOAP messages are not tied to any particular current or future transport protocol.

SOAP-based Web services have several years of successful deployment within enterprises. The SOAP-based approach is heavily promoted by major software vendors who offer fully automated solutions for migrating existing APIs with SOAP code generation. While SOAP-based Web services have been widely adopted by the industry and supported by almost all development tools, the SOAP-based approach has the following limitations [15]:

- *Complexity*: Deploying a SOAP-based service requires much experience due the complexity of the Web service protocol stack. Additionally, serializing and deserializing requests written in native languages into SOAP messages is a time-consuming and resource-intensive process, which contradicts the limitations of mobile devices.
- *Accessibility and interface*: The service is exposed to the public using a single endpoint API. Therefore, all the service functionalities and access information are encapsulated within the service description file, hence, all operations use the POST method.
- *Interoperability*: Each Web service has its own service interface. The description information is unique for each service and is exposed by a single WSDL file. Once the client discovers the service, the enclosed binding information in the WSDL file is used to communicate with the service and to construct the requests. Whenever these bindings change, the corresponding communications and requests have to change accordingly.
- *Performance*: High performance overhead exists in SOAP-based Web service due to the usage of XML and lengthy SOAP messages. Moreover, WSDL file and SOAP messages usually, include redundant information which in turn increases the network traffic and consumes more resources.
- *Data Model*: SOAP-based approach hides the data model behind the Web service interface. This feature dictates that the service consumer and provider have to share a common model to communicate. However, SOAP advocates argue that keeping the data model away from the clients is safer and less risky.
- *Scalability*: The SOAP messages are interpreted only outside the Web by different applications. Since consumers and providers must establish a common ground to be able to communicate, scalability is an issue as it fails to achieve the proper integration with the Web as a shared information model.

2) *REST-based*: RESTful Web services gained much attention from the Web community due to their simplicity and scalability. Major Web services providers such as Google, Amazon, Yahoo, and eBay adopted the RESTful Web services approach in their offered Web services. RESTful Web services [15] conform with the concepts of REST in order to avoid the performance degradation resulting from the use of SOAP and XML. Services designed with the RESTful approach expose their functionality as Web resources, each resource

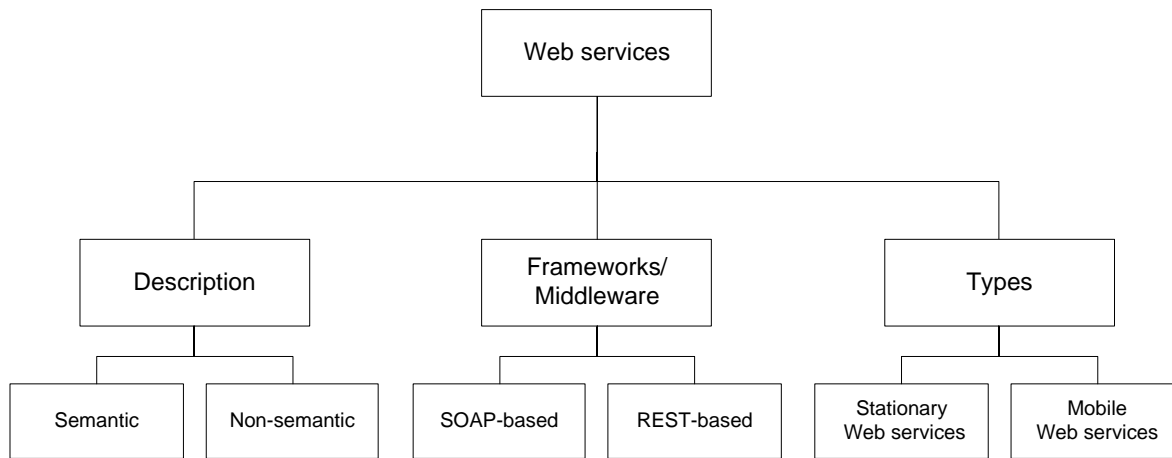

Fig. 1. A general overview of Web service descriptions, design styles, and service types.

is addressed with a unique URI. A user can access the desired resource directly by the associated URI or traverse offered functionality through a hierarchical structure. RESTful approach offers great flexibility and scalability. Although it is tightly coupled with the HTTP protocol, the approach is more suitable to mobile domains. Performance evaluation studies show that RESTful Web services outperforms their SOAP-based counterparts within resource-constrained environments. In this regard, extensive performance analysis has been conducted to investigate the performance aspects of the two design frameworks [16], [17], [18], [19], [20], [21], [22].

The RESTful approach features the following advantages over the SOAP-based approach that make it more desirable and widely adopted [15] in mobile domains.

- **Scalability:** The RESTful approach inherits the underlying scalability of HTTP.
- **Addressability:** Resources (services) are exposed and accessed through a valid URI rather than requiring a centralized repository to manage publishing and discovery. Each resource has its own unique URI, which can be fetched while the user navigates through the link connections between resources.
- **Links and Connections:** Resources can link to each other using hyperlinks and state transfer can be managed through the referral to links.
- **Stateless:** Requests in the RESTful approach are self-contained. This independence allows the ability to delete the related information to a request once it is done. REST principles dictate that HTTP messages should be "self-descriptive", which implies that any intermediary node can fully interpret messages, understand it, and take actions upon its content on behalf of the user.
- **Unified Interface:** All resources are dynamically handled by a limited set of standard HTTP methods, namely, GET, PUT, DELETE, and POST. Any HTTP client can communicate directly with any HTTP server without any further special configuration. In contrast, SOAP needs both client and server (or consumer and provider) to

agree and be aware of method names, data types, and addressing model. The main reason for this is because SOAP is a protocol framework, whereas HTTP is an application protocol [11].

Despite the aforementioned features and advantages for the RESTful approach, there are some valuable lessons that SOAP can teach RESTful to add beyond what HTTP can contribute [11].

- **Security:** Data that needs to be secure can not be sent inline with the URI. HTTP GET encapsulates data parameters in the request, which risks the data and becomes itself a security threat. SOAP is the better solution when it comes to wrapping a large amount of data. Though HTTP has security features, adopting the WS-Security model (supported by SOAP) would strengthen the RESTful approach.
- **Routing:** Routing HTTP messages between different players is controlled by the underlying network. This means in cases where control over routing is required to determine a path between the client and the provider, HTTP is not the best solution. For example, SOAP messages have the ability to allow the headers to be directed to a particular intermediary (i.e. a proxy or cache)
- **Asynchronous Execution:** It does not make sense to have the client wait for a lengthy execution to complete. There should be a way, such as a call back, for either the client or the server to re-establish the communication channel whenever the result is available. SOAP has the ability to perform either synchronous or asynchronous execution.
- **Service Level Agreement:** Usually, SOAP-based services have a contract between the service provider and consumer. This contract includes terms and conditions, guaranteed QoS, reliability and availability, payments, etc. It also specifies how to handle conflict between providers and the consumers whenever terms or conditions are violated.

Table I gives a summary of our comparison between SOAP-based Web services and REST-based Web services design

TABLE I  
A SUMMARY COMPARISON OF WEB SERVICES DESIGN APPROACHES

Feature	SOAP-based	REST-based
Architecture Style	Service-centric	Resource-centric
Coupling	Tightly coupled	Loosely coupled
Transport Protocol	Any	HTTP only
Access Scheme	Single end-point	URI for each resource
QoS	WS specifications	Transport-dependable (HTTP)
Invocation	RPC-like	HTTP methods
Interface	Interface for each Web service	Web browser
Description	WSDL	No standard
Data Model	Hidden	Exposed
Data Representation	XML	XML, JSON, etc.
Scalability	None	Connected hyperlinks
Security	WS-security-based	HTTP-based

style.

### B. Web Service Description

The interactions of a Web service usually involve three parties: a service provider, a service consumer, and occasionally a service broker. Once a Web service is developed, the provider has to define the specification of how to perform service requests and describe the Web service functionalities and how potential consumers can access and invoke the required functionalities. Generally speaking, Web services can be described using either *semantic* or *non-semantic* approaches.

1) *Non-semantic Description*: Non-semantic Web services are described by the Web Service Description Language (WSDL). WSDL enable service providers to describe their services and explain to potential customers how to consume offered functionalities [14]. WSDL 2.0 is the latest WSDL standard specification [14]. It describes the service in two levels; “*emphabstract*” and “*concrete*”. The *abstract* level describes the operations that can be performed by the service and the message structures used to communicate to these operations, as well as an interface which combines messages and operations. The *concrete* level specifies the service bindings associated with the network endpoints.

A Web service description involves various aspects such as information model, functional capabilities, nonfunctional parameters, and technical specifications. The information model defines the data model comprising input/output messages and other data relevant to the service operation. Functional capabilities determine the operations offered by the service and how potential customers can interact with the service. Nonfunctional parameters specify both the environmental and running parameters such as QoS, reliability, availability, etc. Technical specifications are mainly concerned with implementation details such as message structures, transport protocols, service location, and access information. The non-semantic description approach describes Web services at a *syntactic* level [23]. According to the previously mentioned description aspects, non-semantic approach describes the information model using XML schema, while a WSDL interface describes the functional capabilities. The nonfunctional parameters are determined by means of WS-specifications in terms of policies and agreements. The technical details are defined through service bindings and endpoints information.

A WSDL 1.1/WSDL 2.0 document describes a Web service using six major components:

- `<types>/<types>` element is an XML data type definition that describes the data containers used in message exchanges. The element name did not change in WSDL 2.0.
- `<message>/NA` element is an abstract representation of the transmitted information. Typically, a message contains one or more logical parts (parameters). These parts are associated with a type definition. In the skeleton of WSDL 2.0 the `message` element is removed as a global element and the description of messages is encapsulated in the `interface` element.
- `<port>/<endpoint>` the port/endpoint defines the access point of the Web service.
- `<portType>/<Interface>` is an important component in WSDL documents, in which a set of abstract operations (functions) that can be performed by the Web service are defined. Each operation is associated with an input and/or output message.
- `<binding>/<binding>` component specifies the communication protocol and data format for each operation and message defined in a particular port-Type/interface element.
- `<service>/<service>` element is a composite operation that aggregates multiple related ports or functions.

WSDL 2.0 specifications enable the integration of the REST approach and Web services through the introduction of HTTP binding specifications. For each operation provided by the service description, some HTTP parameters (if applicable) can be defined such as URI, HTTP method, input/output data serialization, etc. The main objective of providing such a specification extension in WSDL 2.0 is to enable services with both SOAP and HTTP bindings.

2) *Semantic Description*: Describing Web services semantically relies on *ontologies* [24]. An *ontology* is a formal explicit specification of a shared conceptualization [25]. From this conceptual definition the essential components are extracted which constitute the individual ontologies; they define an agreed common terminology by providing concepts, and relationships between the concepts [12]. Ontologies are structured in a class hierarchy, each class represents a property or a function.

Semantic descriptions of web services aim to provide unambiguous definitions to the description terms and to address the lack of understanding of the semantic meaning of messages and data, which in turn makes the interactions between services more logical and facilitate composition and integration of Web services. In contrast to the non-semantic approach, the semantic description can incorporate non-functional specifications such as those requirements that can be observed at the runtime such as availability, reliability, and security, or those that can be realized at the design time such as extensibility and scalability. Semantic Web services are anticipated to contribute in the transformation of the Web from information-based to knowledge-based services.

In the semantic approach, services are described by profiles, models, and groundings. The service profile contains the information related to the service functionalities, which is needed by the service requester to match the service with the required task. The service model describes the service implementations, required inputs, and expected outputs. It also can be used by the requester to refine the search results. The service information model is defined through domain ontologies. Functional details are represented by capabilities and functional categories whereas non-functional parameters are described using ontologies that describe different non-functional properties. Technical issues such as bindings and protocols are defined the same way as in WSDL documents [23]. Service grounding defines the service accessibility. More precisely, the service is advertised, registered, and discovered through the service profile. Once the service is located, the requester uses the service model and grounding together in order to access it [26], [27].

Web services may use various semantic description languages such as Web ontology languages (OWL-S) [28], Web Service Modeling Ontology (WSMO) [12], WSMO-Lite [23], Web Services Semantics (WSDL-S) [29], and Semantic Web Services Ontology (SWSO) [30], [12]. Even with the standardization efforts, each description language has its own notation and no universally accepted formal notations yet exist for semantic descriptions. Services that are described in a particular semantic description language would only be discovered by requests constructed by the same semantic formalism.

A similar approach to ontologies that can be categorized under semantic descriptions is folksonomies [31]. Folksonomies adopts Web 2.0 social participation to tag Web resources based on user conceptions using user-generated metadata. Folksonomies are recently employed in the Web service domain to tag and discover required services [32]. Although this approach is scalable and offers great flexibility, it may suffer from inaccuracy due to lack of common terminologies or ambiguous tagging by inexperienced users. Filtering techniques and vocabulary controlling mechanisms, therefore, are required to improve the accuracy and reliability of the folksonomy approach. In contrast to ontologies, folksonomies share the same concept but with different implementation. However, non-taxonomic relations between tags can be generated from folksonomies in order to construct ontology-like structures [33]. Folksonomy structures are less resource-intensive and

more lightweight that can better accommodate the resource constraints of mobile environments, while offering higher flexibility and maintaining reasonable reliability.

With the adoption of mobile services, the expected number of offerings is quite high. Therefore, searching for the right service(s) for a particular objective is a key challenge. The syntactic level of description, offered by a non-semantic description, does not enable the automation of service discovery and integration. Semantic annotations augment the capabilities of service description and make it machine consumable based on meaning and understanding, not just on the syntax. However, semantic discovery is a resource-intensive process that conflicts with the resource constraints of mobile environments. This problem can be approached in two ways, either augmenting the capability of mobile devices through cloud computing [34], [35] or optimizing semantic descriptions and reasoning to accommodate the various constraints of mobile environments [36]. Cloud computing seems to be more reasonable approach, especially with the latest widespread deployments and adoption of cloud services. Bringing the power of the Cloud to the realm of mobile services opens up the opportunities to employ advanced techniques that were deemed beyond the capability of resource-constrained environments, such as semantic approaches.

Table II summarizes the differences between non-semantic and semantic description approaches, emphasizing the advantages and disadvantages of each approach.

### C. Types of Web Services

We classify Web services based on the type of host. Web services that are provided by fixed servers and consumed by stationary clients are called *stationary Web services*, whereas services that are hosted and provided or consumed by mobile devices are called *mobile Web services*. This paper focuses on mobile Web services and applicability of provisioning from resource-constrained mobile devices. The next section explains and elaborates more on both types of Web services.

1) *Stationary Web Services*: Stationary Web services are deployed on fixed servers, such as Amazon and Google Web services. They are usually tied to the availability of local resources such as databases hosted on the local data center [37]. These Web services are accessible by both fixed and mobile consumers through their advertised unique addresses. Stationary Web services are reliable and can provide guaranteed QoS due to abundant resource availability in fixed environments. Computational and network resources can scale up and down to accommodate variations in demands, while maintaining a high level of resource utilization. Stationary Web services, therefore, can serve a huge number of users. Services can be replicated on multiple servers to support distributed provisioning and/or avoid a single point of failure and offer better service reliability and guaranteed quality. Service replication decisions could be static based on prespecified conditions, at design time, or dynamic at runtime according to context changes.

Web service communication schemes are independent of the type of consumers and providers, which means that the



TABLE II  
A COMPREHENSIVE COMPARISON BETWEEN SEMANTIC AND NON-SEMANTIC WEB SERVICE DESCRIPTION APPROACHES

Feature	Non-semantic	Semantic
Information model description	XML-Schemas	Domain ontologies
Functional descriptions	WSDL interface	Capabilities and functional categories
Nonfunctional descriptions	NA	Ontologies (policies and properties)
Behavioral descriptions	NA	pre & post-conditions
Technical descriptions	WSDL bindings and communication protocols	Same as in WSDL
Search	Keyword based	Semantic reasoning

communication strategies do not care whether one or both of the communication parties are mobile nodes [38]. Traditional Web services are designed to behave synchronously, i.e. users are blocked while executing. In mobile domains, the synchronous execution of long-lived processes is not the right choice. Regular functionality of mobile terminals, such as voice calls or running applications, must be maintained during the execution of Web services whether the terminal is a consumer or provider.

2) *Mobile Web Services*: Mobile Web services are deployed on mobile devices and provisioned over wireless networks [2], where devices may play the role of consumer, broker, or provider. Mobile services is a fairly new and many challenges with respect to the limitations of mobile devices and the characteristics of broadband wireless access remain open. Mobile Web services was first introduced as a computing paradigm in the early twenty-first century. Since then, much of the of research efforts have focused on enabling reliable mobile service provisioning despite the limitations of mobile environments. These limitations are summarized as the following along with respective challenges:

*Limited Resources*. Although the capabilities of mobile devices have improved in terms of processing power, memory space, and embedded sensors, they continue to lag behind other forms of computing devices. The major constraint for mobile devices is their limited display screens which can relatively display smaller amounts of data at a time, resulting in compromising the usability of applications. So, mobile devices (smartphones in particular) are still recognized as resource-constrained computing devices [39], [40].

*Intermittent Connectivity*. Mobile devices frequently change network operators and may handover between different technologies within the same network. Mobile devices are expected to experience frequent link failures and consequently any services they may be offering would become temporarily unreachable. This presents big challenges for providing reliable Web services in highly dynamic mobile wireless environments. Therefore, mobile Web services are not suitable for services that are expected to be continuously available [41].

*Addressability*. Mobile devices may frequently change their point of attachment to the network as they relocate. Changing the network provider or network technology typically results in changing the mobile provider's IP address (unless a static IP is assigned), which in return makes services' binding information invalid if not properly updated [42]. Therefore, mobile Web services might become stale or inaccessible.

*Scalability*. Given the limited resources of a mobile device,

mobile Web services do not scale well when a large number of customers are expected to concurrently access the Web service [17].

*Battery Power*. The possibility of battery power outage remains a major challenge for the potential growth of mobile computing. Recent developments in mobile computing and the growing popularity of mobile applications outpace what current battery technologies can provide [43].

*Resource Heterogeneity*. The operating systems and software platforms on mobile devices span multiple vendors and feature a wide range of characteristics and supporting functionalities. Providing an interoperable mobile service that is platform-independent and still can perform uniformly across heterogeneous platforms is another dimension of stringent constraints imposed by mobile environments.

Due to the aforementioned mobile wireless characteristics, many conventional Web service protocols and mechanisms have been adapted as well as new supporting platforms have been developed suitable for the deployments on mobile domains. We briefly highlight a non-exclusive list of these platforms as follows.

- **Java ME**: Java platform, Micro Edition (J2ME) [44] is the successor of PJava and is the most ubiquitous Java application platform for mobile devices. A broad range of embedded devices use J2ME as the Java runtime platform. J2ME comes pre-installed on most of the current smartphones. Currently, J2ME comes in one of two platforms. The first one is *Connected Device Configuration (CDC)* to support high end mobile devices such as tablets and some powerful smartphones with the base set of APIs and virtual machine. The other one is *Connected Limited Device Configuration (CLDC)* to provide the same kind of support but for mobile devices that experience intermittent wireless connections and have relatively limited resources such as smartphones. On top of CLDC and CDC, *Mobile Information Device Profile (MIDP)* provides the Java runtime environment for Java mobile applications on most of today's mobile devices.
- **kXML2**: kXML2 [45] is a lightweight XML parser designed specifically for constrained environments.
- **kSOAP2**: kSOAP2 [46] is a lightweight SOAP implementation adapted for resource-constrained devices to overcome the significant overhead of the original SOAP implementation. kSOAP2 is an open source SOAP web service client library that processes SOAP messages based on kXML2 parser. The basic functionality of

kSOAP2 is to convert the data types in SOAP messages into Java data objects. gSOAP is the kSOAP equivalent for C and C++ with some additional capabilities for creating Web services stubs from WSDL.

In the next section, we present the current and potential mobile applications and domains that can benefit from the mobile services.

### III. POTENTIAL APPLICATIONS OF MOBILE SERVICES

The approach of mobile Web services introduces a new range of mobile applications that promise advanced mobile computing paradigms, differential user experience, and seamless data access across different platforms. One of the chief benefits that mobile services offer is the enabling of personalized service provisioning, where services are specifically customized and tailored at the best interest of the service requester and most appropriate for the current situation. This is due to the fact that mobile devices are associated with users who have personal preferences, beside the ability to access various contextual information. In general, mobile Web services open up opportunities for users who wish to share personal information and functionalities, yet still maintain full control over their personal data. The utility of mobile Web services may extend to domains that are deemed beyond the capabilities of mobile devices. Such domains include:

*Location-based applications.* Most users carry their mobile phones with them for the majority of the time. While users move, they may offer access (with various privileges) to real-time context, such as location, air pollution levels, luminosity, and noise levels. Location-based applications are expected to benefit the most from personal services' ability to guarantee privacy under the provider's control.

*Healthcare monitoring.* Mobile devices may provide low-cost mobile and efficient remote health monitoring by utilizing the mobile services approach. Mobile devices can collect a patient's vital signs in a real-time fashion using the sensors embedded in the mobile device, where applicable, or via communication with a body sensor network without interfering with the activities of the patient [47]. These data, then, may be offered or made available upon request to caregivers of interest who wish to follow changes in the patient's health conditions. Consequently, caregivers may provide the appropriate medical assistance or promptly respond to a critical health concern. Mobile services could also provide instant access to continuously changing context attributes, such as a patient's location.

*Personal publishing.* An author writing articles or blog posts may request feedback from close friends or professionals using mobile services. While giving a lecture or presentation, a speaker could also receive questions and comments from the audience via Web services hosted on his/her mobile devices.

*Mobile learning.* In mobile learning (m-learning) scenarios [48], learners can share resources such as videos, audio, documents and comments. Participants in m-learning may also assume one or more roles including learners, mentors and

peer-tutors. With mobile services, participants can manage their own learning profile, including their progress and expertise, and share their experience with friends or learning partners while maintaining their privacy.

*Personal information.* Personal profile, photo/video sharing, and schedules are amongst the applications that can potentially benefit from the concept of mobile services.

*Personal social networking.* A clique of friends may dynamically form a private social network while keeping all their personal information, social status, posts, and updates on their mobile devices [49], [50]. Personal Web services would enable users to maintain their social profile and allow friends to access their social information without sharing data with a third party.

### IV. ARCHITECTURES OF MOBILE SERVICES

Over the past few years, several researchers have proposed different architectures and frameworks for providing Web services from mobile devices. These studies center around the possibility of hosting Web services on resource-limited devices. Each one of these approaches addresses and deals with certain challenges facing mobile services such as reachability, reliability, and scalability.

Most of the current mobile service architectures are still in their infancy stages [16]. Pauer et al. [51] discuss briefly different mobile service architectures and classify them into three categories, proxy-based, Peer-to-Peer, and asymmetric. In this section, we discuss in details current architectures, illustrating the merits and shortcomings of each one, and comparing them side-by-side.

#### A. Proxy-based Architecture

The proxy-based mobile service architecture is the easiest approach for avoiding many challenges facing the implementation of providing Web services from resource-constrained devices such as traditional protocol compatibility and scalability. The proxy is usually a high-end machine attached to the fixed networks. Therefore, it theoretically has unlimited bandwidth to minimize the bandwidth usage in mobile networks and enough processing power to offload the resource-constrained devices and perform the resource-intensive processes. Proxy-based architectures offer caching to support disconnected mobile services and accommodate high access demands, while maintaining reasonable latency.

From implementation perspectives, proxy-based architectures relies on Jini technology [52]. Jini is an infrastructure based on Java to enable building federated network services. The infrastructure is comprised of a join/discovery protocol and lookup service. The lookup service is the major component of the system which serves as a repository of services, whereas the join/discovery protocol publishes and discovers network services.

Figure 2 shows an abstract overview of the proxy-based architecture. It consists of a mobile device hosting Web services and is connected wirelessly to a high-end machine acting as a proxy. The proxy represents the endpoint of Web

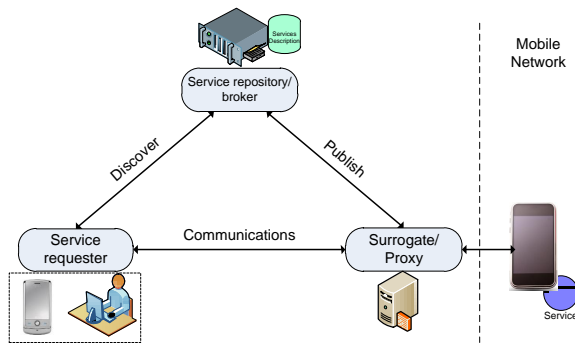

Fig. 2. An abstract overview of proxy-based mobile Web service architecture.

services to the clients. Web services are published by the proxy to the look-up directory/registry which represents a service broker for both providers and clients. Potential clients discover the requested services through the lookup directory, get the binding information, and contact the proxy directly to use the corresponding service. The intercommunication between the mobile service provider and the proxy server ensures that the provided service is up-to-date.

Proxy-based architectures resolve many challenges facing mobile Web services. For example, proxies are more capable than mobile devices to serve a large number of clients simultaneously with acceptable performance and response time. Proxies also deal with different protocol translations, since most of Web service protocols are not originally designed for wireless communications (i.e. are not optimized to tolerate high-latency, unreliable communications, and intermittent connections). A proxy-based architecture can guarantee a reasonable QoS in contrast to a fully wireless domain wherein providing a particular level of QoS is quite difficult. Proxies can also hide the heterogeneity of various mobile devices and support mobile terminals with disconnected states [53].

### B. P2P-based Architecture

Peer-to-Peer (P2P) technology is a distributed, low-cost, and collaborative computing paradigm. The vision of the P2P mobile Web service architecture is to overcome the limitations of centralized approaches and to take advantage of the flexibility that P2P architectures offer. Figure 3 illustrates the basic architecture of providing Web services from mobile devices over P2P networks. It also shows how P2P-based, proxy-based, and asymmetric architectures may coexist to form a hybrid architecture. P2P mobile service architecture relies on the P2P network advertising mechanism to publish and discover Web services. The P2P network advertising mechanism handles node mobility and dynamically manages the location and binding information of the Web service in WSDL documents through the lifetime concept. P2P advertisements are associated with a lifetime parameter, whenever the lifetime expires the advertisement must be republished to stay valid, otherwise, it is removed automatically or marked invalid. This mechanism of managing the publication of services eliminates

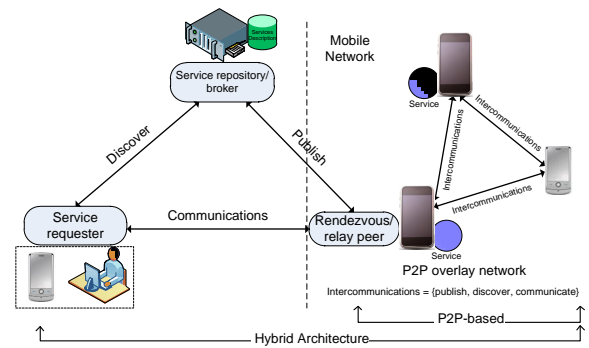

Fig. 3. P2P-based architecture of mobile Web service architecture.

the task of keeping centralized services registries consistent and up-to-date.

The most popular implementation of P2P mobile Web services uses JXTA technology [54], [55], where publication and discovery of services are handled using JXTA protocols. Services are advertised as JXTA modules, where a module is composed of a module class, a module specification, and a module implementation. This corresponds to WSDL and UDDI in the traditional Web services approach. Clients must join the P2P network and get a *PeerID* before they are able to discover services. The mapping between the current IP address and the PeerID of a client is managed by the underlying JXTA protocols. Clients can query the network for required services while they are connected. Once the required service is located, the client communicates with the service provider through JXTA pipes in order to send and receive messages.

Personal Service [56], [57] is a recent implementation of mobile Web service provisioning based on the P2P architecture. Personal services are intended to offer a range of personal data services either with limited authorized access (e.g., healthcare services [58] and multimedia sharing) or public access (e.g, crowdsourcing and participatory sensing). The authors propose a set of new techniques for service publication, discovery, and directory. All these techniques promote collaborative computing through distributing required processing amongst all participating nodes.

### C. Asymmetric Architecture

The asymmetric approach follows the traditional Web service architecture as shown in Figure 4 except that the service provider is a mobile device. The term asymmetric was coined by Porta [53] for those approaches that address the resource limitations of mobile devices. Figure 4 shows the architecture of asymmetric mobile service architecture.

Several adaptations have been proposed for traditional Web service protocols and mechanisms to accommodate the limitations of mobile devices. For example, asymmetric architecture supports only simple XML data types such as *String*, *Integer*, and *Char*, to avoid complex type extraction [51]. Another example is the utilization of the *Asynchronous Service Access Protocol (ASAP)* [59] in the communication of mobile services. ASAP is specifically designed by OASIS to target the

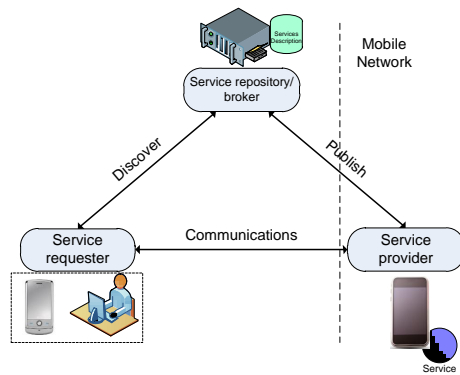

Fig. 4. Overview of asymmetric mobile service architecture.

service interactions in long-lived mobile services. ASAP enables services to run asynchronously and independently from their caller service. In such scenarios, the client invokes the service and waits for the response without blocking the device during the execution. The response is send back whenever it is available or a separate request can be made later by the client to communicate the results of the Web service operations. ASAP implements asynchronous interaction techniques such as “*Callback*”, where the server sends the response to the client whenever it is ready or “*Polling*”, where the client re-establishes a connection later to check whether the results are ready. ASAP allows the client to query the Web service for its current status during the execution time. It also enables clients to send updates to change their previous information. This is to accommodate changes in the client requirements during the course of prolonged execution times. Asynchronous Web services though should have the ability to update their behaviour accordingly at runtime.

Recent studies have shown the feasibly of asynchronous mobile service provisioning. Elgazzar et al. [41] propose a generic framework for efficient Web services provisioning in mobile heterogeneous environments. The framework aims at exploiting the inherent ubiquity of mobile devices and their association to a specific context in order to provide reliable and personalized service in an ad-hoc fashion. Aijaz et al. [38] purpose asynchronous mobile Web services middleware that supports the asynchronous execution of long-lived services. The framework supports both “*Callback*” and “*Polling*” service interaction techniques. Kim and Lee [5] propose a high level description of framework that hosts Web services on mobile devices and supports service migration. Their framework handles interrupted connections through service migration to a new suitable host to maintain service reliability. The migration can be triggered by providers or upon detection of service disruption for example, due to overload or battery outage.

Table III provides a comparison between different approaches. While the existing proxy-based and P2P architectures rely on other technologies for setup, such as Jini and JXTA, the asymmetric approach can work with no infrastructure support, for example over direct WiFi links. However, several performance concerns associated with the asymmetric

architecture remain challenging, most importantly the resource limitations of mobile providers. Recently, mobile cloud computing has become a driving force for mobile services, where the cloud offers computational resources on demand to augment the capability of resource-constrained mobile providers [35]. Service architectures that adopt mobile cloud computing fall under the asymmetric category, since mobile providers remain the destination for service requests.

#### D. Open Research Issues

The distinct features of mobile services and the constraints of mobile devices introduce a number of critical design challenges for efficient architectures. None of the proposed architectures achieves some sort of balance between performance and reliability. The simplicity and scalability of the proxy-based architecture compromise its portability and consistency. The robustness of the P2P architecture sacrifices its reliability. The performance of the asymmetric approach falls short due to the resource limitations on mobile devices as well as the possibility of intermittent connectivity.

Although significant steps have been taken towards the realization of reliable mobile Web services, many challenges remain open. Next, we highlight some of the open research issues that require further investigation.

- **Architecture:** Current mobile Web service architectures are basically adapted from the traditional Web service approach. Rethinking the architecture would lead to better solutions for mobile service provisioning. Robust architectures that limit the overhead on resource-limited providers and that meet the requirements of mobile environments are needed. Cloud computing is a viable option that needs further investigations on how it can support reliable mobile service provisioning.
- **Frameworks:** SOAP/WSDL are the defacto standards used by Web services. This framework poses challenges on resource-constrained environments due to verbose XML and its significant resource demands of parsing. Optimizations made to accommodate the constraints of mobile environments often compromise the performance. Efficient frameworks must be generic to fit the various requirements of heterogenous mobile platforms and device form factors. Therefore, a platform-independent framework for mobile services is definitely required.
- **Performance:** The widespread adoption of the mobile service approach is only possible if architectures and frameworks are capable of achieving reasonable performance without seriously affecting the regular functionality of mobile devices, such as voice services. The performance of mobile service needs further investigation.
- **Context-awareness:** Context information makes service personalization possible. Mobile services must take advantage of the association of mobile devices to particular users to provide differential user experience through personalization. Additionally, context information such as mobile capabilities, available add-on devices, location and user profile offers great opportunity to augment mobile service provisioning in terms of target publishing,

TABLE III  
COMPARISON SUMMARY BETWEEN DIFFERENT MOBILE SERVICE ARCHITECTURES

Feature	Proxy-based	P2P-based	Asymmetric
Architecture style	Decentralized	Distributed	Centralized
Core technology	Jini architecture	JXTA protocols	Traditional Web services architecture
Communications	Through the proxy	Peer talk to Peer	Clients talk directly to providers
Addressing	Announce the proxy address	Unique PeerID	IP-based
Service publishing	Jini Join request	JXTA advertisements	UDDI
Service discovery	Lookup service discovery (UDDI-like)	JXTA resource discovery	Query the UDDI
Service invocation	Access the proxy + RMI	Communicate the provider peer + HTTP	Access the provider + HTTP
Scalability	Can serve a large number of concurrent customers	Scale as peers join	Limited number of concurrent customers
Consistency	Synchronization between the proxy and the mobile provider	Advertisements associated with lifetime	Consistent
QoS	Guaranteed	Unguaranteed	Unguaranteed

discovery, and usage. Efficient models are desired in order to incorporate context information to mobile services.

- **Data Formats:** Though XML is a portable format, its message parsing is resource-intensive due to verbosity and redundancy. Less complex and concise data formats would bootstrap the performance of mobile services.
- **Supporting Toolkits:** Mobile devices have limited input capabilities and small screens. Deploying and managing mobile Web services in such environments is quite challenging. However, developers can take advantage of unique features of mobile systems, such as multimodality and embedded capabilities (cameras, GPS, microphones, etc.), to develop robust and powerful interfaces that facilitate the deployment and user interactions with services. Such interfaces would leverage the use of mobile services.
- **Asynchronous Execution:** Users cannot tolerate lengthy locking of their terminals while executing mobile services. Limited bandwidth and intermittent connectivity pose additional challenges to lengthy Web service processes. In addition, clients of mobile Web services may prefer to disconnect while the service continues execution. Therefore, robust asynchronous techniques are of high interest to the mobile Web service approach.
- **User Feedback:** Web 2.0 has enabled users to share their user experience with others. Mobile users tend to trust the user-perceived quality of service more than claimed by service providers. Efficient utilization of user feedback leverages the adoption of mobile services. Therefore, new approaches are required to efficiently handle users feedback and maintain reliable service ratings.

## V. WEB SERVICES PUBLISHING AND DISCOVERY

Publishing a Web service is the process of notifying users with the existence of such a service and providing all the required information to access it. Providers have two options to publish their services: either to register services with a service broker in a public service repository, using the UDDI standard, or to advertise them in a local service directory that is publicly accessible. Service brokers usually provide a Web interface for their service registry that accepts information about providers, their service technical interface (tModel), and description files.

In contrast, Web service discovery is the process of finding a Web service that fulfils a certain task. Service discovery is a crucial component of any service centric system. The possibility of system failure is 100% if the discovery process fails to find the correct service.

Most of the existing discovery techniques belong to one of three main categories [60]: UDDI Business Registry (UBR), specialized search engines, and generic search engines. A comprehensive comparison between these approaches including advantages and shortcomings of each, is given in [39].

Service discovery should demand minimal user involvement, especially in mobile domains where users have limited input capabilities. A comparison between current discovery mechanisms focusing on the autonomic capability of service discovery is presented in [61]. The comparison is carried out based on eight criteria that evaluate how autonomous these approaches are. These criteria are service description, matchmaking/reasoning, scalability, robustness, service composition, Quality and cost of service, up-to-dateness , and service replacement.

The discovery process is quite different according to the Web service description method. Semantic Web services are discovered by high level match-making approaches [6], whereas non-semantic Web services discovery use information retrieval techniques [59] based on keyword matching.

### A. Non-semantic Discovery

In the WSDL-based service discovery approach, a Web service discovery engine partially matches the search terms (keywords) entered by the user with the Web service name, location, business, or tModel [62] defined in the service description file. The use of these types of keywords is, by design, limited in WDSL specifications. A relevant service may not be retrieved if the search terms do not include part of the Web service name. A user may even miss services that use synonyms or variations of these keywords. For example, a service that contains "car" in its name may not be retrieved by a query looking for "vehicle" service. A solution to this problem is proposed by Elgazzar et al. [63] via clustering WSDL documents based on functional similarity.

The WSDL-based service discovery approach works on the syntactic level and lacks the understanding of the semantics

of Web service functionalities. Thereby, building a common ground between the provider and the consumer is difficult, especially in pervasive environments [64]. In such environments, service discovery should be robust and lightweight enough to cope with the network's dynamics and resource-constrained mobile devices. Furthermore, important parameters such as QoS, user context, and other non-functional parameters cannot be exploited in discovering the most appropriate Web service to the requested task using WSDL-based approach. The semantic approach introduces solutions to these discovery issues using semantic reasoning.

### B. Semantic Discovery

A common problem for all current semantic approaches is that they must apply the same formalism to describe the service capabilities and the service request (a solution is introduced to tackle this problem in [65]). Then, a matchmaking process is performed to match the request requirements with the offered capabilities. The matchmaking process is comprised of three steps: 1) parsing both the user request for requirement and service profile for capabilities, 2) using a semantic reasoner to load the ontologies used by the user request and service advertisement, 3) finding the semantic relation between inputs, outputs, and properties of the requested and provided functionalities and capabilities. Step 2 and 3 are carried out by a semantic reasoner such as Racer<sup>1</sup> and Fact++<sup>2</sup>. A service is discovered if a "match" relation holds between advertised capabilities ( $C_A$ ) and requested capabilities ( $C_R$ ). In such a relation, a semantic match means that  $C_A$  subsumes  $C_R$ . More precisely, all required inputs, expected outputs, and required properties of  $C_R$  are matched with the expected inputs, offered outputs, and provided properties by  $C_A$ , respectively. The result would be a group of Web services which are ranked according to a best-fit criteria.

The performance parameters that distinguish one semantic reasoner from another are: 1) the response time, which is the time taken to match a request with the capabilities provided by Web services, 2) the computational resource requirements used in matching. Thus, in order to feasibly employ the semantic discovery approach in mobile services, the matching process should be optimized for these performance metrics.

Amigo-s [64] is a semantic description language developed to advertise and discover Web services in pervasive and resource-constrained computing environments using a dedicated Service Discovery Protocol (SDP). A number of optimizations were considered such as, offline classification for offered ontologies, hierarchical categorization for requested capabilities, and distributed service directories. However, in the case of resource-constrained mobile providers/brokers, the overhead of service classification could be infeasible; especially if the set of available services is constantly changing as providers/brokers move around.

### C. Service Discovery in Mobile Environments

Limited resource availability on mobile devices and unreliable communication in wireless networks present unique challenges for service discovery. A vision for discovery schemes in open mobile environments is presented by Bashah et al. [66]. Mobile providers and users are constantly changing their locations and might offer, or be interested in, location-based services. Mobile users' attitude, preferences and demands for location-aware mobile services are discussed from the user perspective by Kaasinen et al. [67].

Several studies have focused on overcoming specific limitations of mobile service discovery, such as semantic reasoning. Steller et al. [68], [69], [36] propose the mTableaux algorithm to optimize the reasoning process and facilitate Web services selection for limited-resource mobile providers. Similarly, Gu et al. [70] discuss the design principles and implementations of supporting ontology and reasoning for mobile context-aware applications. Bhuvaneswari et al. [71] propose a framework for semantic Web service composition in mobile environments. It converts WSDL files into an OWL-S specification and generates a service profile for the request. Then, it performs semantic reasoning between the advertised service profile and the requested one. The composer generates composition plans and stores it in a plan repository in a cloud. Yang et al. [72] propose an architecture for mobile Web service discovery, aiming at avoiding intermittent connections and overcoming delay and bandwidth limitations. Their architecture enables mobile users to download and execute services locally in order to avoid unnecessary back and forth communication. However, this approach overlooks many issues that typically exist in mobile service such as, access remote local, depletion of mobile resources, and consistency of services.

Much attention has been given to context-aware service discovery in heterogeneous mobile environments. Such context includes user preferences, device profiles, environment parameters and service ratings. Elgazzar et al. [73] propose a personalized Web service discovery approach that uses various context information to discover services that best fit the user interests. DaaS [74] is a context-aware cloud-based platform that offers discovery as a service. It exploits the capability of cloud computing to leverage elastic resource provisioning to support advanced resource-intensive discovery techniques. DaaS offers robust service discovery through the integration of the user context and preferences with the discovery process. García et al. [75] propose a detailed user preferences model that can be applied as an extension to the existing semantic description languages. The model distinguishes between mandatory requirements and preferred ones. Al-Masri et al. [76] have developed a device-aware service discovery mechanism that is capable of selecting Web services that adhere to mobile device constraints. The mechanism takes advantage of HTTP sessions to collect device information and store it at the server side. This information is later used to ensure that the discovered services will function properly within the user's device.

User feedback and rating is also another important aspect that could be used to improve Web service discovery [77].

<sup>1</sup>Racer: <http://www.sts.tu-harburg.de/r.f.moeller/racer/>

<sup>2</sup>Fact++: <http://owl.man.ac.uk/factplusplus/>



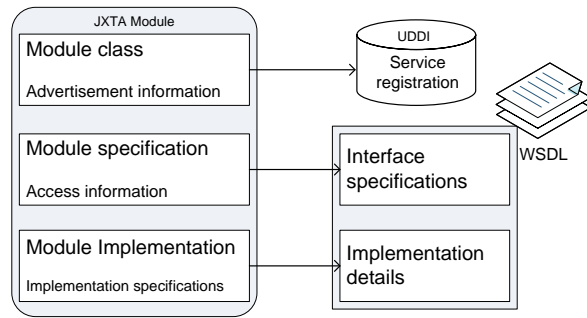

Fig. 5. Mapping between JXTA advertisements and traditional Web service publishing architecture.

However, mechanisms that collect the feedback should prevent false ratings as well as providers who dishonestly claim a certain QoS for their advertised services to falsely attract customers [78]. Maamar et al. [79] discuss the development, discovery, and composition of capacity-driven Web services, which change their behavior according to environment changes. Similar research on services with different qualities to cope with environment context is presented in [80].

#### D. Discovery in P2P Networks

Peers in P2P networks are always on the move, changing their point of connection to the network. Consequently, the binding information of an advertised mobile service needs to be updated accordingly. Improper handling of service binding information results in failed invocations. Maintaining such binding information consistent is costly and challenging in mobile environments.

In contrast to the traditional Web service model, advertisement and discovery of mobile services in P2P follows the announce-listen model. Most of the existing research efforts concerning publishing and discovery in P2P networks relies on JXTA technology. Such implementation publishes Web services as a JXTA modules, where each module include module class, module specification, and module implementation [54]. The module class represents the information needed to declare the services. The module specification contains the information required for the potential consumer to access the service. Its implementation indicates the methods (possibly across different platforms) of the advertised specifications. Modules are searchable and can be queried for a certain Web service requirement or functionality. Its class maps to the UDDI entry in the traditional Web service architecture as shown in Figure 5, while the module specification and module implementation together map to the WSDL document information [4]. Advertisements in JXTA are represented as XML documents and broadcast/multicast over the P2P network. A determined lifetime is associated with each advertisement; once it expires the corresponding service or advertisement becomes invalid or automatically deleted. This feature reduces the need of maintaining up-to-date centralized registries. To keep a service advertisement valid, the service should be periodically republished or re-announced.

Peers discover the required services by sending a search request over the network [81]. The JXTA API supports only keyword-based search in advertised modules. The user's query is matched against the information in the module class. Therefore, information such as the user's context is not used to find the relevant service using the basic JXTA search. Sirarma [4] propose an advanced search mechanism through categorization of advertisements, based on functionalities, and filtering of retrieved services. The filtering algorithm relies on the word importance calculation across all the retrieved advertisements considering the word frequency and its distribution. However, such search mechanisms need a high-end JXME peer due to the resource limitations of the regular mobile devices [82]. The scalability of P2P-based mobile Web service discovery is also studied by Zhu [83].

Sioutas et al. [84] take advantage of P2P overlay networks and propose a fault tolerant search infrastructure based on indexing techniques to leverage Web service discovery in P2P networks. Sets of descriptive keywords are extracted from WSDL description files, indexed, then stored at peers. Request-query matching supports keyword-matching on service name, category, and tModel. Vu et al. [78] propose a decentralized service discovery framework based on indexed P2P service registries. A semantic service description, including functional and non-functional properties, is stored on a peer registry on P2P overlay network. The requirements of a potential requester are expressed in the same ontology concept used to describe the *characteristic vector* of the service.

Recently, Elgazzar et al. [56] propose a new approach to advertise and discover services in P2P mobile environments, capitalizing on the unique features of mobile devices. The approach uses contact lists, ranging from phonebook and emailing lists to social circles, to advertise and discover personal services. Their approach also proposes an access control scheme that places service providers in full control over service functionality and access management. The authors adopt a distributed service directory approach, in which each node maintains its own copy of service registry to distribute the processing load across participating nodes and alleviate the burden on limited mobile resources.

#### E. Open Research Issues

In addition to the publishing/discovery approaches discussed above, several open issues still exist requiring improvements or possibly new mechanisms all together.

- **Publishing Techniques:** In mobile domains, centralized approaches are prone to failure due to limited resources and unreliable connections. In contrast, distributed publishing approaches entail much overhead in maintaining the consistency of service registries. This raises a fundamental question, what is the best way to publish services in mobile environments? Is location-based publishing beneficial in reducing network traffic and latency or functional-based publishing is more appealing for mobile users? Is it possible and beneficial for mobile network operators to favor local services, i.e. offered from inside their own networks, at the expense of similar services



offered outside? These questions remain open and warrant further investigation.

- **Discovery Mechanisms:** With the adoption of mobile services, a significant number service offerings are expected. This will make the discovery of the most relevant Web services to a certain user objective more challenging. Although semantic approaches yield better results, their resource demands are beyond what mobile devices can afford. Efficient discovery mechanisms, that are capable of utilizing the various context information that mobile devices can offer, are at the core of leveraging service personalization.
- **User Interface:** Services with user-friendly interfaces are of greater interest to mobile users. Developers have more options to develop appealing multimodal interfaces for mobile users, leveraging embedded capabilities of mobile devices. Robust toolkits that build upon such features are highly desired for the adoption of mobile services. The decision of whether to generate adaptive user interfaces during discovery or at the development time is a significant research question in of itself, taking into consideration the constraints of both mobile devices and networks.

## VI. PERFORMANCE OF MOBILE SERVICES

Overcoming the resource limitations of mobile devices is a challenge that continues to be at the core of the research interests for the realization of reliable pervasive and mobile services. Notwithstanding the research efforts that have focused on enabling Web service provisioning from resource-constrained providers, many limitations with respect to mobile environments remain. Several studies address the resource limitations on mobile devices while providing mobile services from different perspectives. Some studies propose offloading resource-intensive tasks to either the cloud [34], [43], [85] or nearby capable computing machines [86]. The offloading approach offers mobile devices the flexibility to customize the service interactions and optimize the resource consumption [87]. Even though the offloading approach is a good candidate to augment the capabilities of mobile devices, it needs a good partitioning strategy to balance the tradeoff between the amount of data transfer and the reduction in the amount of mobile resource consumption. Using the cloud to augment mobile capabilities is still an immature research venue and requires several optimizations to bootstrap mobile services.

From another perspective, researchers propose techniques to fit service-related aspects within constraints and peculiarities of mobile environments, such as semantic reasoning strategies [70], [36], [71]; location-based mobile services [67]; context-aware discovery [88], [89]; incorporating user preferences with the discovery process [75]; device-aware discovery [76]; capacity-driven services [79], [80]; service composition in a mobile environment [71]; adaptive interfaces and web content presentations for mobile devices [90]. It turns out that these approaches still incur lots of overhead on resource-constrained mobile providers. This is due to the fact that these approaches and proposals try to cure the symptoms and not the cause of

the problem. In fact, the core problem is that the architectures and technique borrowed from other domains (viz. standard Web service approach) are inefficient in providing reliable and scalable Web services in mobile domains due to the distinct characteristics of mobile environments and the constraints of mobile devices.

Four different approaches proposed in the literature to tackle the performance issue of mobile services are as follows:

- **XML Compression:** Compression of XML messages is one option to boost the mobile Web services performance [91], [92]. However, the performance benefits that compression may bring are compromised by the decompression overhead. Therefore, service developers need to tradeoff between bandwidth and computing resources. Most of the proposed XML compression schemes allow users to choose whether they prefer to receive XML messages compressed or not.
- **REST Design:** The RESTful approach is another option to enhance the performance of mobile services. Several studies investigated the performance of SOAP-based and REST-based services within resource-constrained environments [18], [22], [16] and results show that RESTful Web services outperform SOAP services.
- **Partitioning:** Partitioning the execution of Web service components is a third direction that has been proposed to hide the limitations of mobile devices. Typically the Web service execution environment encompasses many components to facilitate the hosting and execution of services, such as a request listener, SOAP/XML engine, and encryption and decryption modules. Most of these components are computationally intensive. Deploying all the required components on mobile devices is difficult due to their resource constraints. Asif et al. [93], [94] propose a partitioning technique to execute some of the Web service components on an intermediary node, called a surrogate node. Their basic idea is to build a distributed SOAP engine, a static partition resides on the surrogate node and a mobile partition resides on the mobile device, to improve the response time and scalability. However, Web services must be developed with this concept in mind, as XML elements would have to assignment attributes for each SOAP engine. It is worth noting that this technique is a variation of the proxy-based architecture.
- **Service Replication:** Availability and reliability are major challenges for mobile services due to the intermittent connectivity and limited host capability. Service replication is another proposed option to improve the performance of mobile services. Sheng et al. [37] presents an approach for mobile service replication on idle potential providers. The primary service provider maintains a ready-to-deploy (a bundle that contains all the necessary files) version of the Web service for various mobile and desktop platforms. A Web service manager constantly maintains a pool of potential service hosts and triggers replication once a prespecified performance constraint is violated, such as response time or concurrent invocation

requests exceed a certain threshold.

## VII. SUMMARY

Recent years have witnessed a paradigm shift in the role of mobile devices as service providers. The mobile Web service paradigm has emerged due to the successful coupling between the advancements in mobile device manufacturing and the developments of wireless technologies. The chief advantage of providing Web services from mobile devices is that both provider and consumer can utilize the context information to personalize mobile services. Mobile services opens up new range of mobile applications that promise advanced mobile computing paradigms, differential user experience, and seamless data access across different platforms. This paper provides the state-of-the-art of mobile services, pointing out enabling technologies and potential applications and bringing forward various challenges and open research issues.

Mobile Web services may be designed following one of two approaches, SOAP-based or REST-based. SOAP-based is an object oriented approach, where operation is the core component, while REST-based is a resource oriented approach, where a resource is the main constituent. Although SOAP services are built on rigid specifications, RESTful approach has been proven the better choice for resource-constrained environments. Several architectures are proposed in the literature for mobile services including, proxy-based, P2P-based, and asymmetric architecture. Despite the fact that a proxy-based architecture can hide the limitations of mobile devices, such a solution compromises the portability of service provisioning. Existing publishing and discovery mechanisms were originally developed for fixed hosting and wired networks. However, mobile environments are dynamic and users constantly change their point of connection to the network. Efficient publishing and discovery mechanisms that are capable of capturing the characteristics and accommodate the constraints of mobile environments are definitely required and crucial to the widespread adoption of mobile services.

In conclusion, although significant steps have been taken towards the realization of reliable mobile services, many research challenges remain open and need further investigation.

## REFERENCES

- [1] Portio Research Mobile Factbook 2013, <http://www.portioresearch.com/media/3986/Portio%20Research%20Mobile%20Factbook%202013.pdf>. [Accessed: July, 2013].
- [2] S. N. Srirama, *Mobile Hosts in Enterprise Service Integration*. PhD thesis, RWTH Aachen, Germany, September 2008.
- [3] M. A. Skulason, "Mobile devices as web service providers," Master's thesis, Technical University of Denmark, Denmark, September 2008.
- [4] S. N. Srirama, M. Jarke, and W. Prinz, "Mobile web service provisioning," in *The Advanced International Conference on Telecommunications and International Conference on Internet and Web Applications and Services*, pp. 120–125, 2006.
- [5] Y.-S. Kim and K.-H. Lee, "A lightweight framework for mobile web services," *Computer Science - Research and Development*, vol. 24, pp. 199–209, 2009.
- [6] S. Srirama, M. Jarke, and W. Prinz, "Mobile host: A feasibility analysis of mobile web," in *The 4th International Workshop on Ubiquitous Mobile Information and Collaboration Systems*, pp. 942–953, 2006.
- [7] A. Meads, A. Roughton, I. Warren, and T. Weerasinghe, "Mobile service provisioning middleware for multihomed devices," in *Proceedings of the 2009 IEEE 5th International Conference on Wireless and Mobile Computing, Networking and Communications (WIMOB 2009)*, pp. 67–72, 2009.
- [8] A. van Halteren and P. Pawar, "Mobile service platform: A middleware for nomadic mobile service provisioning," in *IEEE International Conference on Wireless and Mobile Computing, Networking and Communications, 2006 (WiMob'2006)*, pp. 292–299, IEEE Computer Society Press, June 2006.
- [9] M. N. Huhns and M. P. Singh, "Service-oriented computing: Key concepts and principles," *IEEE Internet Computing*, vol. 9, pp. 75–81, 2005.
- [10] D. Booth, H. Haas, F. McCabe, E. Newcomer, M. Champion, C. Ferris, and D. Orchard, "Web services architecture," February 2004. <http://www.w3.org/TR/ws-arch>. [Accessed: March 2014].
- [11] P. Prescod, "Roots of the rest/soap debate," August 2002.
- [12] D. Roman, U. Keller, H. Lausen, J. de Bruijn, R. Lara, M. Stollberg, A. Polleres, C. Feier, C. Bussler, and D. Fense, "Web service modeling ontology," *Applied Ontology*, vol. 1, pp. 77–106, November 2005.
- [13] R. T. Fielding, *Architectural styles and the design of network-based software architectures*. PhD thesis, University of California, Irvine, USA, 2000.
- [14] R. Chinnici, J.-J. Moreau, A. Ryman, and S. Weerawarana, "Web services description language (wsdl) version 2.0 part 1: Core language," June 26 2007. <http://www.w3.org/TR/wsdl20>. [Accessed: March 2014].
- [15] J. Meng, S. Mei, and Z. Yan, "Restful web services: A solution for distributed data integration," in *International Conference on Computational Intelligence and Software Engineering*, pp. 1–4, 2009.
- [16] F. AlShahwan and K. Moessner, "Providing soap web services and restful web services from mobile hosts," *International Conference on Internet and Web Applications and Services*, vol. 0, pp. 174–179, 2010.
- [17] R. Mizouni, M. Serhani, R. Dssouli, A. Benharref, and I. Taleb, "Performance evaluation of mobile web services," in *The 9th IEEE European Conference on Web Services*, pp. 184–191, September 2011.
- [18] H. Hamad, M. Saad, , and R. Abed, "Performance evaluation of restful web services for mobile devices," *International Arab Journal of e-Technology*, vol. 1, pp. 72–78, January 2010.
- [19] K. Wagh and R. Thool, "A comparative study of soap vs rest web services provisioning techniques for mobile host," *Journal of Information Engineering and Applications*, vol. 2, pp. 12–17, 2012.
- [20] F. Belqasmi, R. Glioth, and C. Fu, "Restful web services for service provisioning in next-generation networks: a survey," *IEEE Communications Magazine*, vol. 49, pp. 66–73, December 2011.
- [21] C. Pautasso, O. Zimmermann, and F. Leymann, "Restful web services vs. "big" web services: making the right architectural decision," in *The 17th international conference on World Wide Web*, pp. 805–814, 2008.
- [22] F. Aijaz, S. Z. Ali, M. A. Chaudhary, and B. Walke, "Enabling high performance mobile web services provisioning," in *The IEEE 70th Vehicular Technology Conference*, p. 6, September 2009.
- [23] D. Fensel, F. Fischer, J. Kopeck, R. Krummenacher, D. Lambert, and T. Vitvar, "Wsmo-lite: Lightweight semantic descriptions for services on the web." W3C Member Submission, 2010. <http://www.w3.org/Submission/WSMO-Lite>. [Accessed: March 2014].
- [24] L. Cabral, J. Domingue, S. Galizia, A. Gugliotta, V. Tanasescu, C. Pedrinaci, and B. Norton, "Irs-iii: A broker for semantic web services based applications," in *The 5th International Semantic Web Conference*, pp. 201–214, 2006.
- [25] T. R. Gruber, "A translation approach to portable ontology specifications," *Knowledge Acquisition*, vol. 5, no. 2, pp. 199–220, 1993.
- [26] M. Klusch, B. Fries, and K. Sycara, "Automated semantic web service discovery with owls-mx," in *Proceedings of 5th International Conference on Autonomous Agents and Multi-Agent Systems (AAMAS)*, 2006.
- [27] J. D. Garofalakis, Y. Panagis, E. Sakkopoulos, and A. K. Tsakalidis, "Contemporary web service discovery mechanisms," *Contemporary Web Service Discovery Mechanisms*, vol. 5, pp. 265–290, September 2006.
- [28] M. Burstein, J. Hobbs, O. Lassila, D. McDermott, S. McIlraith, S. Narayanan, M. Paolucci, B. Parsia, T. Payne, E. Sirin, N. Srinivasan, K. Sycara, and D. M. (ed.), "Owl-s: Semantic markup for web services." W3C Member Submission, 2004. <http://www.w3.org/Submission/OWL-S>. [Accessed: March 2014].
- [29] R. Akkiraju, J. Farrell, J. Miller, M. Nagarajan, M.-T. Schmidt, A. Sheth, and K. Verma, "Web service semantics - wsdl-s." W3C Member Submission, November 2005. <http://www.w3.org/Submission/WSDL-S>. [Accessed: March 2014].

- [30] S. Battle, A. Bernstein, H. Boley, B. Grosz, M. Gruninger, R. Hull, M. Kifer, D. Martin, S. McIlraith, D. McGuinness, J. Su, and S. Tabet, "Semantic web services ontology (swso)." W3C Member Submission, 2005. <http://www.w3.org/Submission/SWSF-SWSO/>. [Accessed: March 2014].
- [31] A. Mathes, "Folksonomies - cooperative classification and communication through shared metadata," 2004. <http://www.adammathes.com/academic/computer-mediated-communication/folksonomies.html>.
- [32] P. Reddy and A. Damodaram, "Web services discovery based on semantic similarity clustering," in *CSI Sixth International Conference on Software Engineering*, 2012.
- [33] C. Trabelsi, A. B. Jrad, and S. B. Yahia, "Bridging folksonomies and domain ontologies: Getting out non-taxonomic relations," *The IEEE 12th International Conference on Data Mining Workshops*, pp. 369–379, 2010.
- [34] M. Hassan, W. Zhao, and J. Yang, "Provisioning web services from resource constrained mobile devices," in *The IEEE 3rd International Conference on Cloud Computing*, pp. 490–497, 2010.
- [35] K. Elgazzar, P. Martin, and H. Hassanein S., "Empowering mobile service provisioning through cloud assistance," in *The 6th IEEE/ACM International Conference on Utility and Cloud Computing*, December 9–12 2013.
- [36] L. A. Steller, *Light-Weight and Adaptive Reasoning for Mobile Web Services*. PhD thesis, Monash University, Australia, May 2010.
- [37] Q. Z. Sheng, Z. Maamar, J. Yu, and A. H. H. Ngu, *Information Systems: Modeling, Development, and Integration*, ch. Robust Web Services Provisioning through On-Demand Replication, pp. 4–16. Springer Berlin Heidelberg, April 2009.
- [38] F. Aijaz, B. Hameed, and B. Walke, "Towards peer-to-peer long lived mobile web services," in *Proceedings of the 4th International Conference on Innovations in Information Technology*, (Dubai, UAE), pp. 571–575, IEEE, November 2007.
- [39] K. Elgazzar, H. S. Hassanein, and P. Martin, "Effective web service discovery in mobile environments," in *P2MNETS, The 36th IEEE Conference on Local Computer Networks (LCN)*, pp. 697–705, October 2011.
- [40] Q. Z. Sheng, B. Benatallah, and Z. Maamar, "User-centric services provisioning in wireless environments," *Communications of the ACM*, vol. 51, pp. 130–135, Nov. 2008.
- [41] K. Elgazzar, P. Martin, and H. Hassanein, "A framework for efficient web services provisioning in mobile environments," in *The 3rd International Conference on Mobile Computing, Applications, and Services*, Springer's LNICST, October 2011.
- [42] S. Srirama, V. Lor, E. Vainikko, and M. Jarke, "Supporting mobile web service provisioning with cloud computing," *International Journal On Advances in Internet Technology*, vol. 3, no. 3& 4, pp. 261–273, 2011.
- [43] E. Cuervo, A. Balasubramanian, D.-k. Cho, A. Wolman, S. Saroiu, R. Chandra, and P. Bahl, "Maui: Making smartphones last longer with code offload," in *The 8th international conference on Mobile systems, applications, and services*, pp. 49–62, 2010.
- [44] The Java ME Platform, <http://www.oracle.com/technetwork/java/javame/index.html>. [Accessed: March 2014].
- [45] N. Balani, "Using kxml to access xml files on j2me devices," 2003. <https://www6.software.ibm.com/developerworks/education/wi-kxml/wi-kxml-a4.pdf>.
- [46] kSOAP2, <http://ksoap2.sourceforge.net/>. [Accessed: March 2014].
- [47] K. Elgazzar, M. Aboelfotoh, P. Martin, and H. S. Hassanein, "Ubiquitous health monitoring using mobile web services," in *The 3rd International Conference on Ambient Systems, Networks and Technologies*, August 2012.
- [48] C.-S. Wang and Y.-H. Wang, "Design of an soa-based ubiquitous learning environment," in *The IEEE International Conference on Granular Computing*, pp. 697–702, November 2011.
- [49] K. Church, J. M. Pujol, B. Smyth, and N. Contractor, "Mobilehci'10 workshop summary: social mobile web," in *The 12th international conference on Human computer interaction with mobile devices and services*, (New York, NY, USA), pp. 509–512, ACM, 2010.
- [50] D. Brooker, T. Carey, and I. Warren, "Middleware for social networking on mobile devices," in *The Australian Software Engineering Conference*, (Auckland, New Zealand), pp. 202–211, 2010.
- [51] P. Pawar, S. Srirama, B.-J. van Beijnum, and A. van Halteren, "A comparative study of nomadic mobile service provisioning approaches," in *The 2007 International Conference on Next Generation Mobile Applications, Services and Technologies (NGMAST 2007)*, pp. 277–283, 2007.
- [52] Jini Architecture Specification. <http://river.apache.org/doc/specs/html/jini-spec.html>. [Accessed: March 2014].
- [53] T. F. L. Porta, K. K. Sabnani, and R. D. Gitlin, "Challenges for nomadic computing: Mobility management and wireless communications," *Mobile Networks and Applications*, vol. 1, no. 1, pp. 3–16, 1996.
- [54] L. Gong, "Jxta: a network programming environment," *IEEE Internet Computing*, vol. 8, pp. 88–95, 2001.
- [55] JXTA(TM) Community Project, <https://jxta.dev.java.net>.
- [56] K. Elgazzar, H. S. Hassanein, and P. Martin, "Towards personal mobile web services," in *The 2013 IEEE Wireless Communication and Networking Conference (WCNC)*, pp. 4606 – 4611, 7–10 April 2013.
- [57] K. Elgazzar, H. S. Hassanein, and P. Martin, "Personal web services: Architecture and design," Technical Report 2012-597, Queen's University, Kingston, ON K7L2N8, October 210. 17 pages.
- [58] K. Elgazzar, M. AboElFotoh, P. Martin, and H. S. Hassanein, "Ubiquitous health monitoring using mobile web services," in *The 3rd International Conference on Ambient Systems, Networks and Technologies (ANT)*, pp. 332–339, August 2012.
- [59] J. Fuller, M. Krishnan, K. Swenson, and J. Ricker, "Oasis asynchronous service access protocol (asap)," May 2005. [http://www.oasis-open.org/committees/documents.php?wg\\_abbrev=asap](http://www.oasis-open.org/committees/documents.php?wg_abbrev=asap). [Accessed: March 2014].
- [60] S. Hagemann, C. Letz, and G. Vossen, "Web service discovery - reality check 2.0," in *The 3rd International Conference on Next Generation Web Services Practices*, (Washington, DC, USA), pp. 113–118, IEEE Computer Society, 2007.
- [61] M. Rambold, H. Kasinger, F. Lautenbacher, and B. Bauer, "Towards autonomic service discovery a survey and comparison," in *The 2009 IEEE International Conference on Services Computing*, (Washington, DC, USA), pp. 192–201, IEEE Computer Society, 2009.
- [62] R. Nayak, "Data mining in web services discovery and monitoring," in *International Journal of Web Services Research*, vol. 5, pp. 63–81, 2008.
- [63] K. Elgazzar, A. E. Hassan, and P. Martin, "Clustering wsdl documents to bootstrap the discovery of web services," in *The 8th IEEE International Conference on Web Services (ICWS'10)*, Miami, Florida, USA, July 2010.
- [64] S. Ben Mokhtar, A. Kaul, N. Georgantas, and V. Issarny, "Efficient semantic service discovery in pervasive computing environments," in *The ACM/IFIP/USENIX International Conference on Middleware*, (New York, NY, USA), pp. 240–259, Springer-Verlag New York, Inc., 2006.
- [65] M. Junghans, S. Agarwal, and R. Studer, "Towards practical semantic web service discovery," in *ESWC (2)*, pp. 15–29, 2010.
- [66] N. S. K. Bashah, I. Jørstad, and D. v. Thanh, "Service discovery in future open mobile environments," in *The Fourth International Conference on Digital Society*, (Washington, DC, USA), pp. 47–53, IEEE Computer Society, 2010.
- [67] E. Kaasinen, "User needs for location-aware mobile services," *Personal and Ubiquitous Computing*, vol. 7, pp. 70–79, 2003.
- [68] L. Steller and S. Krishnaswamy, "Efficient mobile reasoning for pervasive discovery," in *ACM symposium on Applied Computing*, (New York, NY, USA), pp. 1247–1251, ACM, 2009.
- [69] L. A. Steller, S. Krishnaswamy, and M. M. Gaber, "Cost efficient, adaptive reasoning strategies for pervasive service discovery," in *The International Conference on Pervasive Services*, pp. 11–20, 2009.
- [70] T. Gu, Z. Kwok, K. K. Koh, and H. K. Pung, "A mobile framework supporting ontology processing and reasoning," in *The 2nd Workshop on Requirements and Solutions for Pervasive Software Infrastructures*, (Austria), September 2007.
- [71] A. Bhuvaneshwari and G. Karpagam, "Reengineering semantic web service composition in a mobile environment," *International Test Conference*, pp. 227–230, 2010.
- [72] X. Yang, A. Bouguettaya, and B. Medjahed, "Organizing and accessing web services on air," *IEEE Transactions on Systems, Man, and Cybernetics Part A: Systems and Humans*, vol. 33, pp. 742–756, 2003.
- [73] K. Elgazzar, P. Martin, and H. Hassanein S., "Personalized mobile web service discovery," in *The IEEE 9th World Congress on Services*, July 2013.
- [74] K. Elgazzar, H. S. Hassanein, and P. Martin, "Daas: Cloud-based mobile web service discovery," *Pervasive and Mobile Computing*, 2013.
- [75] J. M. García, D. Ruiz, and A. Ruiz-Cortés, "A model of user preferences for semantic services discovery and ranking," in *ESWC 2010, Part II*, vol. 6089 of LNCS, pp. 1–14, 2010.
- [76] E. A.-M. Q. H. and Mahmoud, "Mobieureka: an approach for enhancing the discovery of mobile web services," *Personal Ubiquitous Computing*, vol. 14, pp. 609–620, October 2010.
- [77] A. Averbakh, D. Krause, and D. Skoutas, "Exploiting user feedback to improve semantic web service discovery," in *Proceedings of the 8th International Semantic Web Conference*, (Berlin, Heidelberg), pp. 33–48, Springer-Verlag, 2009.

- [78] L.-H. Vu, M. Hauswirth, and K. Aberer, "Towards P2P-based Semantic Web Service Discovery with QoS Support," in *BPM Workshops, LNCS 3812*, pp. 18–31, Springer Berlin / Heidelberg, 2006.
- [79] Z. Maamar, S. Tata, D. Belaid, and K. Boukadi, "Towards an approach to defining capacity-driven web service," *International Conference on Advanced Information Networking and Applications*, pp. 403–410, 2009.
- [80] A. Tao and J. Yang, "Context aware differentiated services development with configurable business processes," in *The 11th IEEE International Enterprise Distributed Object Computing Conference*, (Washington, DC, USA), pp. 241–252, IEEE Computer Society, November 2007.
- [81] S. Dustdar and M. Treiber, "Integration of transient web services into a virtual peer to peer web service registry," *Distrib. Parallel Databases*, vol. 20, no. 2, pp. 91–115, 2006.
- [82] S. N. Srirama, M. Jarke, and W. Prinz, "Scalable mobile web service discovery in peer to peer networks," in *The 3rd International Conference on Internet and Web Applications and Services*, pp. 668–674, 2008.
- [83] H. Zhu, "Scalability of p2p based mobile web services discovery," Master's thesis, RWTH Aachen University, Germany, 2008.
- [84] S. Sioutas, E. Sakkopoulos, C. Makris, B. Vassiliadis, A. Tsakalidis, and P. Triantafillou, "Dynamic web service discovery architecture based on a novel peer based overlay network," *Journal of Systems and Software*, vol. 82, pp. 809–824, May 2009.
- [85] I. Giurgiu, O. Riva, D. Juric, I. Krivulev, and G. Alonso, "Calling the cloud: Enabling mobile phones as interfaces to cloud applications," vol. 5896 of *Lecture Notes in Computer Science*, pp. 83–102, Springer Berlin / Heidelberg, 2009.
- [86] M. Satyanarayanan, P. Bahl, R. Caceres, and N. Davies, "The case for vm-based cloudlets in mobile computing," *Pervasive Computing, IEEE*, vol. 8, no. 4, pp. 14–23, 2009.
- [87] P. Bahl, R. Y. Han, L. E. Li, and M. Satyanarayanan, "Advancing the state of mobile cloud computing," in *Proceedings of the 3rd ACM workshop on Mobile Cloud Computing and Services*, MCS '12, (New York, NY, USA), pp. 21–28, ACM, 2012.
- [88] E. Al-Masri and Q. H. Mahmoud, "A context-aware mobile service discovery and selection mechanism using artificial neural networks," in *The 8th international conference on Electronic commerce*, pp. 594–598, 2006.
- [89] N. Blefari-Melazzi, E. Casalicchio, and S. Salsano, "Context-aware service discovery in mobile heterogeneous environments," in *The 16th IST Mobile and Wireless Communications Summit*, pp. 1–5, July 2007.
- [90] B. Adipat and D. Zhang, "Adaptive and personalized interfaces for mobile web," in *The 15th Annual Workshop on Information Technologies & Systems*, pp. 21–26, 2005.
- [91] M. Tian, T. Voigt, T. Naumowicz, H. Ritter, and J. Schiller, "Performance considerations for mobile web services," *Elsevier Computer Communications Journal*, vol. 27, pp. 1097–1105, 2003.
- [92] Y. Natchetoi, H. Wu, and G. Babin, *Euro-Par Parallel Processing*, ch. A Context-Dependent XML Compression Approach to Enable Business Applications on Mobile Devices, pp. 911–920. Springer Berlin Heidelberg, August 2007.
- [93] M. Asif, S. Majumdar, and R. Dragnea, "Partitioning the ws execution environment for hosting mobile web services," *Services Computing, IEEE International Conference on*, vol. 2, pp. 315–322, 2008.
- [94] M. Asif and S. Majumdar, "A graph-based algorithm for partitioning of mobile web services," in *The IEEE International Symposium on Modeling, Analysis & Simulation of Computer and Telecommunication Systems*, 2009.



**Khalid Elgazzar** is a postdoctoral research fellow in the School of Computing at Queen's University. Dr. Elgazzar received his PhD from Queen's University in 2013. He has 8+ years of industrial experience in software design and development, and 9+ years of interdisciplinary academic teaching and research. His research interests span the areas of mobile and ubiquitous computing, context-aware systems, mobile services and applications, and elastic networking paradigms to cope with dynamic applications. Dr. Elgazzar has received several recognitions and best

paper awards at top international conferences. He leads a team on novel Ubiquitous Cloud paradigms.



**Patrick Martin** is a Professor of the School of Computing at Queens University. He holds a BSc from the University of Toronto, MSc from Queens University and a PhD from the University of Toronto. He joined Queens University in 1984. He is also a Visiting Scientist with IBM's Centre for Advanced Studies. His research interests include database system performance, Web services, autonomic computing systems and cloud computing.



**Hossam Hassanein** is a leading authority in the areas of broadband, wireless and mobile networks architecture, protocols, control and performance evaluation. His record spans more than 400 publications in journals, conferences and book chapters, in addition to numerous keynotes and plenary talks in flagship venues. Dr. Hassanein has received several recognition and best papers awards at top international conferences. He is also the founder and director of the Telecommunications Research (TR) Lab at Queen's University School of Computing, with extensive international academic and industrial collaborations. Dr. Hassanein has.

He is a senior member of the IEEE, and is currently chair of the IEEE Communication Society Technical Committee on Ad hoc and Sensor Networks (TC AHSN). Dr. Hassanein is an IEEE Communications Society Distinguished Speaker (Distinguished Lecturer 2008-2010).

# Inverted Pendulum-type Personal Mobility Considering Human Vibration Sensitivity

Misaki Masuda

School of Science for Open and Environmental Systems  
Keio University  
Yokohama, Japan

Takuma Suzuki

Graduate School of Science and Technology  
Keio University  
Yokohama, Japan

Kazuto Yokoyama

School of Science for Open and Environmental Systems  
Keio University  
Yokohama, Japan

Masaki Takahashi

Department of System Design Engineering  
Keio University  
Yokohama, Japan

**Abstract**—An inverted pendulum-type PM (personal mobility) has been attracting attention as a low-carbon vehicle. For many people who like to use the PM, ride comfort is important. However, ride comfort of PM has not been focused on in previous studies. The vibration is one of causes that make riders feel uncomfortable. The PM is unstable system and horizontal vibration may be caused by a stabilizing control. Additionally, vertical vibration may also be caused by road disturbances. This study analyzes the vibration of the rider's head in these two directions when the PM runs on a road with disturbances in numerical simulations, and evaluates ride comfort with the frequency characteristics of the vibration. To consider human vibration sensitivity, the frequency weighting proposed in ISO 2631-1 is used as an evaluation standard. The improvement methods are proposed from both software and hardware, and it is confirmed that the proposed method can improve ride comfort.

**Keywords**—Inverted Pendulum-Type Personal Mobility; Ride Comfort; Human Vibration; Frequency Analysis; Vibration Control; Frequency Shaped LQG

## I. INTRODUCTION

Recently in Japan, the number of single-person households has increased through declining birthrate and a rapidly growing proportion of elderly people, and the population decreases [1]. Based on this current situation, the PM has been attracting attention as a next-generation mobility vehicle. The PM is a vehicle for personal short-distance trips, and it is an electric vehicle. The single-person household using a PM instead of a gasoline vehicle is expected to contribute to the low-carbon society. Studies of dynamics and stability of the PM have been conducted [2]. Studies of model and control characteristics of human on the PM have been recently conducted [3][4]. Many stabilization control methods for the PM have been proposed [5]-[8]. It is important to improve ride comfort so that many people use the PM. However, the ride comfort problem has not been focused on in previous studies.

This paper aims at improving ride comfort of the PM. The model that was studied was an inverted pendulum PM that has many advantages and is widely used. The system of the inverted pendulum PM is unstable. Therefore, horizontal vibration occurs by a stabilizing control. Additionally, vertical vibration occurs when traveling due to road disturbances. This study analyzes the vibration in these two directions and evaluates ride comfort of the occupant considering the human vibration sensitivity. This study proposes an inverted pendulum PM with greater ride comfort using both hardware and software approaches based on the analysis results. To verify its effectiveness, numerical simulations were carried out.

## II. MODELING

### A. Model and Parameter

Figs. 1 (A), (B) and (C) show a coordinate system, a model for numerical simulation, and a model for design of control system respectively. In our study, the models of an inverted pendulum-type PM are limited to two-dimension, horizontal and vertical.

The following variables have been chosen to describe the vehicle (see also Fig. 1):

- $\theta$ : Pendulum angle with respect to z axis.
- $\varphi$ : Tire angle with respect to pendulum angle.
- $u$ : Control input torque.
- $d$ : Displacement of road disturbance.

Parameter definitions and values are collected in TABLE I. Parameters of the vehicle are referring to Segway PT i2 [9]. The occupant was assumed that the height is 1.70 m, and weight is 65.0 kg. This refers to average height and weight of Japanese adult male [10]. Tire stiffness and damping coefficient are referring to the study of Sharp et al [11].

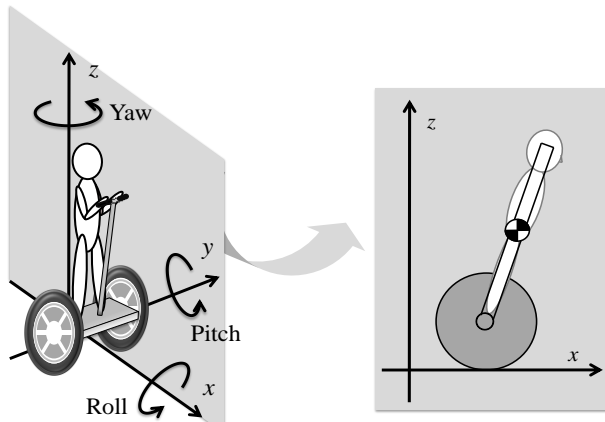

(A) Coordinate system

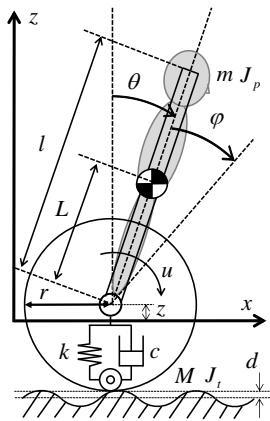

(B) A model for simulation

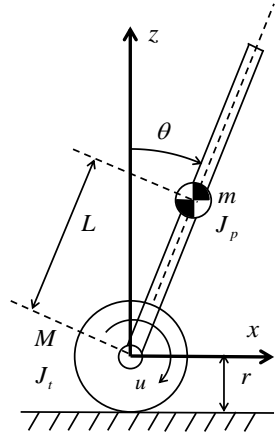

(C) A model for control system design

Fig. 1. Diagrams of an inverted pendulum-type personal mobility

### B. Motion Equations of Model for Numerical Simulation

Coordinates of the center of the tire  $(x_t, z_t)$ , and of the center of gravity of the pendulum  $(x_p, z_p)$  are

$$(x_t, z_t) = (r(\theta + \varphi), z) \quad (1)$$

$$(x_p, z_p) = (x_t + L \sin \theta, z_t + L \cos \theta) \quad (2)$$

In Fig. 1(B), kinetic energy  $T$ , potential energy  $V$ , and dissipation energy  $D$  of the numerical simulation model are

$$\begin{cases} T = \frac{1}{2} M (\dot{x}_t^2 + \dot{z}_t^2) + \frac{1}{2} m (\dot{x}_p^2 + \dot{z}_p^2) + \frac{1}{2} J_p \dot{\theta}^2 + \frac{1}{2} J_t (\dot{\theta} + \dot{\varphi})^2 \\ V = mgL \cos \theta + \frac{1}{2} \cdot 2k(z-d)^2 = mgL \cos \theta + k(z-d)^2 \\ D = \frac{1}{2} \cdot 2c(\dot{z}-\dot{d})^2 = c(\dot{z}-\dot{d})^2 \end{cases} \quad (3)$$

TABLE I. MODEL PARAMETERS

Parameter	Symbol	Unit	Value
Mass of the pendulum	$m$	kg	103.0
Mass of the tires	$M$	kg	10.0
Moment of inertia of the pendulum	$J_p$	kgm <sup>2</sup>	21.7
Moment of inertia of the tire	$J_t$	kgm <sup>2</sup>	0.29
Height of the occupant	$l$	m	1.70
Distance between the tire center and center of gravity of the pendulum	$L$	m	0.70
Radius of the tire	$r$	m	0.24
Tire stiffness	$k$	N/m	$1.0 \times 10^5$
Tire damping coefficient	$c$	kg/s	$1.0 \times 10^2$

By using the Lagrangian, the following motion equations are obtained:

$$\begin{aligned} & \{(M+m)r^2 + 2mrL \cos \theta + mL^2 + J_p + J_t\} \ddot{\theta} \\ & + \{(M+m)r^2 + mrL \cos \theta + J_t\} \ddot{\varphi} - mL \sin \theta \ddot{z} \\ & - mrL \dot{\theta}^2 \sin \theta - mgL \sin \theta = 0 \end{aligned} \quad (4)$$

$$\begin{aligned} & \{(M+m)r^2 + mrL \cos \theta + J_t\} \ddot{\theta} + \{(M+m)r^2 + J_t\} \ddot{\varphi} \\ & - mrL \dot{\theta}^2 \sin \theta = u \end{aligned} \quad (5)$$

$$\begin{aligned} & -mL \ddot{\theta} \sin \theta + (M+m) \ddot{z} - mL \dot{\theta}^2 \cos \theta \\ & + 2k(z-d) + 2c(\dot{z}-\dot{d}) = 0 \end{aligned} \quad (6)$$

### III. DESIGN OF CONTROL SYSTEM

#### A. Motion Equations of the Model for Control System

In Fig. 1(C), the following motion equations are obtained as

$$\begin{aligned} & \{(M+m)r^2 + 2mrL \cos \theta + mL^2 + J_p + J_t\} \ddot{\theta} \\ & + \{(M+m)r^2 + mrL \cos \theta + J_t\} \ddot{\varphi} - mrL \dot{\theta}^2 \sin \theta \\ & - mgL \sin \theta = 0 \end{aligned} \quad (7)$$

$$\begin{aligned} & \{(M+m)r^2 + mrL \cos \theta + J_t\} \ddot{\theta} + \{(M+m)r^2 + J_t\} \ddot{\varphi} \\ & - mrL \dot{\theta}^2 \sin \theta = u \end{aligned} \quad (8)$$

#### B. State-Space Representation

$\theta$  is assumed to be near 0, therefore  $\sin \theta \approx \theta$ ,  $\cos \theta \approx 1$ ,  $\dot{\theta}^2 \approx 0$  are assumed. On this assumption, the equations are linearly approximated, and represented as the following state-space.



$$\dot{\mathbf{x}}_c = \mathbf{A}\mathbf{x}_c + \mathbf{B}u \quad (9)$$

The control target vector is  $\mathbf{x}_c = [\theta \ \dot{\theta}]^T$ .

### C. Design of Optimal Regulator

The design of the optimal regulator has done using three gains. We call them Controller 1, Controller 2, and Controller 3 respectively. TABLE II shows the feedback gains,  $\mathbf{K} = [K_\theta \ K_\dot{\theta}]$ , and the settling time of  $\theta$  of each controller. Control input torque is  $u = -\mathbf{K}\mathbf{x}_c$ . The settling time of  $\theta$  is the time that  $\theta$  has been less than  $1.0 \times 10^{-4}$  rad.

As shown in TABLE II, the controllers have different settling times. Settling time of each controller is relatively slow, medium, and fast.

## IV. CONDITIONS OF SIMULATION AND ANALYSIS

### A. Initial State

State variable vector for numerical simulation model is defined as

$$\mathbf{x} = [\theta \ \varphi \ z \ \dot{\theta} \ \dot{\varphi} \ \dot{z}]^T \quad (10)$$

The initial state vector is

$$\mathbf{x}_0 = [0.017 \ 0 \ 0 \ 0 \ 23.1 \ 0]^T \quad (11)$$

### B. Road Disturbance

There are two types of road disturbance. One is sinusoidal, and the other one is random.

1) *Sinusoidal road: The sinusoidal road is defined as*

$$d = a \sin \omega b x \quad (12)$$

$a$  is amplitude of the disturbance, and  $a = 0.005$  m.  $b$  is a conversion factor. When the PM is traveling at desired speed (in this paper, 5.6 m/s),  $b = 0.180$  so as to satisfy  $\omega b x = \omega t$ . When  $\omega = 2\pi f$  is substituted to Eq. (12), Eq. (12) is assumed to be equivalent to the sinusoidal road displacement whose frequency is  $f$  Hz. In this paper, the frequency is 7 pattern, 0.1, 0.5, 1.0, 5.0, 10.0, 16.0, and 20.0 Hz.

2) *Random road: The design of random road is refer to ISO 8608 [12]. In this paper, classification of road is Level A, B, C, D, and E. Each level means that the road is very good, good, normal, poor, and very poor.*

### C. Target of Analysis

Coordinates of the head of the occupant ( $x_h, z_h$ ) is

$$(x_h, z_h) = (x_t + l \sin \theta, z_t + l \cos \theta) \quad (13)$$

TABLE II. PROPERTIES OF CONTROLLERS

	Symbol	Unit	Controller		
			1	2	3
Feedback gains	$K_\theta$	Nm/rad	-398.5	-404.7	-573.0
	$K_{\dot{\theta}}$	Nm/rad	-94.0	-80.1	-95.3
Settling time	$T$	s	2.00	1.40	0.73

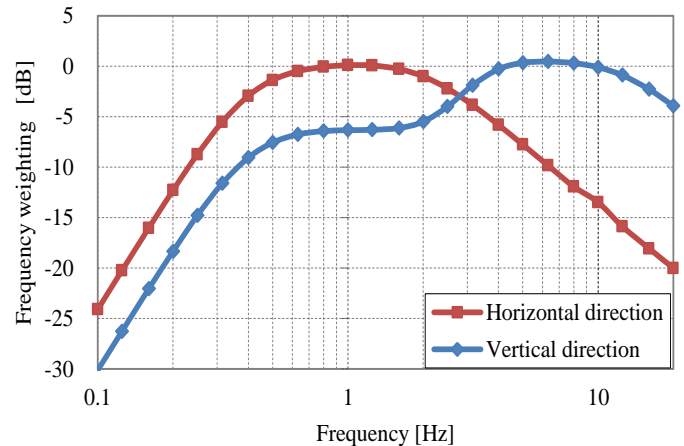

Fig. 2. Frequency weighting curves shown in ISO 2631-1

Acceleration of the head of the occupant is

1)

$$\begin{cases} \ddot{x}_h = \ddot{x}_t + l\ddot{\theta} \cos \theta - l\dot{\theta}^2 \sin \theta \\ \ddot{z}_h = \ddot{z}_t - l\ddot{\theta} \sin \theta - l\dot{\theta}^2 \cos \theta \end{cases} \quad (14)$$

### D. Evaluation Method

In this paper, Power Spectrum Density (PSD) and Root Mean Square (RMS) are used for evaluation.

1) *PSD: PSD is evaluated by using the frequency weighting curves that are proposed in ISO 2631-1 [13], as*

2) *shown in Fig. 2. Fig. 2 shows that the unpleasant frequency range is about 0.8 - 1.6 Hz in the horizontal direction and 4.0 - 8.0 Hz in the vertical direction.*

3) *RMS: RMS is defined [13]:*

$$a_w = \left[ \frac{1}{T} \int_0^T a_w^2(t) dt \right]^{\frac{1}{2}} \quad (15)$$

$T$  is simulation time, in this paper,  $T = 30$  s. The acceleration of the head of occupant is substituted to  $a_w(t)$ . The RMS calculated by Eq. (15) does not reflect human vibration sensitivity. Therefore, the acceleration data is filtered to consider human vibration sensitivity. The transfer function representation of the frequency weighting proposed in ISO2631-1 is used as a filter [14]. The transfer functions are



$$\begin{cases} W_d(s) = \frac{12.66s^3 + 163.7s^2 + 60.64s + 12.79}{s^4 + 23.77s^3 + 236.1s^2 + 692.8s + 983.4} \\ W_k(s) = \frac{80.03s^2 + 989.0s + 0.02108}{s^3 + 78.92s^2 + 2412s + 5614} \end{cases} \quad (16)$$

$W_d$  is the transfer function in the horizontal direction, and  $W_k$  is that in the vertical direction.

## V. EVALUATION OF RIDE COMFORT

Fig. 3 shows a rider's head acceleration when the road disturbance is sinusoidal ( $f = 1.0$  Hz). Figs. 4 and 5 show the PSD and RMS of the head acceleration, respectively. In the horizontal direction, the result is different due to changing the controller, as shown in Fig. 3(A). Figs. 4(A) and 5(A) show that the faster the settling time of the controller is, the better ride comfort become. However when Controller 3, whose settling time is the fastest of the three controllers, is used, the ride comfort gets worse. It is confirmed that if the settling time is less than 1.2 s, the ride comfort gets worse. Therefore, controller whose settling time is too fast, for example, Controller 3, is undesirable as a control system considering the ride comfort. In the vertical direction, the results are almost the same even if the controllers are changed, as shown in Fig. 3(B). The same trends can be seen in Figs. 4(B) and 5(B). This suggests that improving on the control system design is difficult. In addition, in Fig. 4(B), there are two peaks of PSD. One is the frequency of the vibration that is included in the road disturbance. The other is 6.7 Hz on any roads. The frequency, that is the natural frequency of this model, is in the frequency range that human feels uncomfortable in the vertical direction (4.0 - 8.0 Hz). Therefore, in the vertical direction, it is required to change the natural frequency using a hardware approach.

## VI. IMPROVEMENT OF RIDE COMFORT

### A. Proposal for Improving Ride Comfort

**Improvement Method in the Horizontal Direction:** When the optimal regulator controllers are used, the faster the settling time of the controller is, the better ride comfort become. However, if the settling time is too fast, ride comfort gets worse. Therefore we apply a frequency shaping Linear-Quadratic-Gaussian (LQG) controller [15] to control PM as an approach from the control system. Using this method, it is intended to reduce the vibration in the frequency range (0.8 - 1.6 Hz), while keeping the settling time of  $\theta$  about 1.40 s which is the settling time of controller 2. Weighting on the state variable,  $\mathbf{Q}(j\omega)$ , and weighting on the control input,  $\mathbf{R}(j\omega)$ , are designed for the frequency shaping LQG control.  $\mathbf{Q}(j\omega)$  is

$$\mathbf{Q}(j\omega) = \begin{bmatrix} \mathbf{Q}_\theta(j\omega) & 0 \\ 0 & 10^{-2} \end{bmatrix} \quad (17)$$

Fig. 6 shows  $\mathbf{Q}_\theta(j\omega)$  and  $\mathbf{R}(j\omega)$ .  $\mathbf{Q}_\theta(j\omega)$  is designed to take large value in a low-frequency band up to 1.0 Hz, and  $\mathbf{R}(j\omega)$  is designed to take large value in a frequency band

greater than 1.6 Hz. These weightings represented in the transfer functions are as follows.

$$\begin{cases} \mathbf{Q}_{f\theta}(s) = \frac{118.4}{s^2 + 22.6s + 39.5} \\ \mathbf{R}_f(s) = \frac{63.2s^2 + 2222.5s + 9974.7}{157.9s^2 + 11112.6s + 99746.9} \end{cases} \quad (18)$$

The settling time of  $\theta$  is 1.37 s. This time is equivalent to that of the controller 2. We call this LQG controller Controller 4.

**1) Improvement Method in the Vertical Direction:** In the vertical direction, it is confirmed that improving on the control system design is difficult. We propose a change of the tires as a hardware approach.

The natural frequency of the PM's tire is

$$f_n = \frac{1}{2\pi} \sqrt{\frac{2k}{M+m}} \quad (19)$$

Fig. 7 shows the relation between the stiffness of the tire and the natural frequency, when the occupant weight is changed. The occupant weight is 45 - 118 kg, which refers to a manual of Segway PT i2. The current tire stiffness is  $1.0 \times 10^5$  N/m. The natural frequency is always contained in the frequency range (4.0 - 8.0 Hz) in which human feels uncomfortable. In order that the natural frequency is not included in the range, the tire stiffness needs to be more than  $2.0 \times 10^5$  N/m or less than  $2.5 \times 10^4$  N/m.

It is known that the tire stiffness is dependent on the air pressure. The air pressure is dependent on the tire oblateness [16]. The tire oblateness is calculated from the tire width and height. The tire oblateness of the Segway PT i2 is 0.7. To know the tire characteristic of Segway PT i2, we refer to the tire characteristics of automobiles and motorcycles [16][17]. Automobile and motorcycle tires whose oblateness is near 0.7 are selected.

With respect to those tires, the tire stiffness and width are shown in Fig. 8. In Fig. 8, it is confirmed that the stiffness has nearly linear relationship with the tire width. Consequently, using linear interpolation of data of motorcycle tires, we obtain  $k = 2050W + 87000$ .

The tire width can be determined from the desired tire stiffness. If the tire stiffness is more than  $2.0 \times 10^5$  N/m, the tire width needs to be more than 140 mm. In the same way, if the tire stiffness is less than  $2.5 \times 10^4$  N/m, the tire width needs to be less than 55 mm. When tire stiffness is  $2.5 \times 10^4$  N/m, the RMS value is smaller than that when 200000 N/m. Therefore, we propose a tire whose width is 55 mm. When the tire is used, the natural frequency becomes 3.4 Hz.

### B. Simulation Results and Discussion

We proposed improvement methods for each direction: horizontal and vertical. In our proposed method, the two methods are used simultaneously.

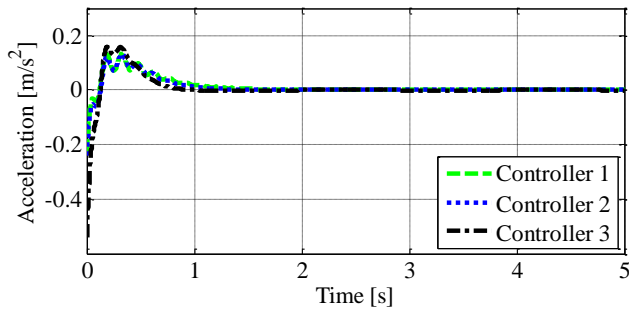

(A) Horizontal direction

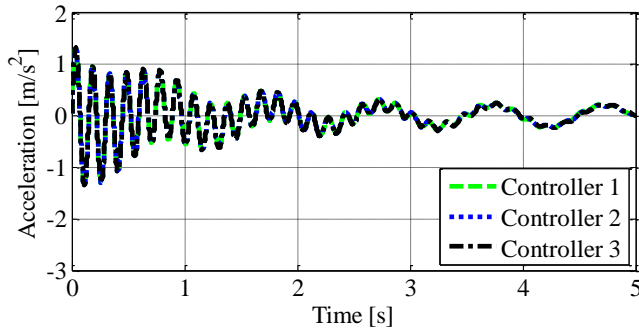

(B) Vertical direction

Fig. 3. A rider's head acceleration (Sinusoidal road,  $f=1.0$  Hz)

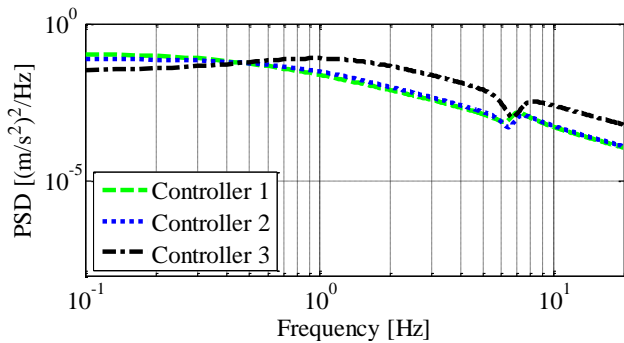

(A) Horizontal direction

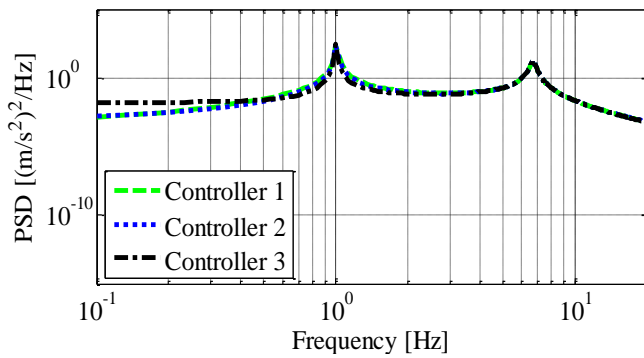

(B) Vertical direction

Fig. 4. PSD of a rider's head acceleration (Sinusoidal road,  $f=1.0$  Hz)

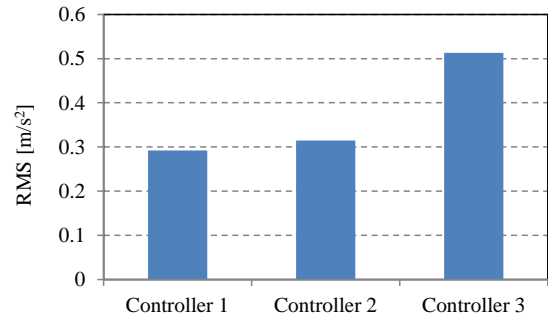

(A) Horizontal direction

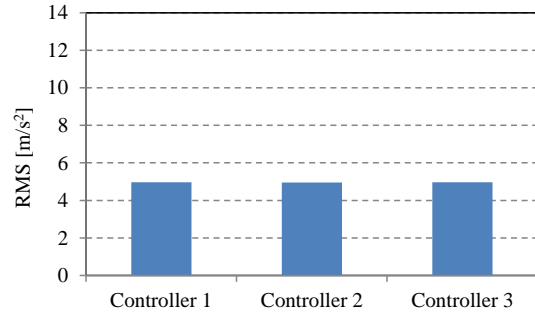

(B) Vertical direction

Fig. 5. RMS value of a rider's head acceleration (Sinusoidal road,  $f=1.0$  Hz)

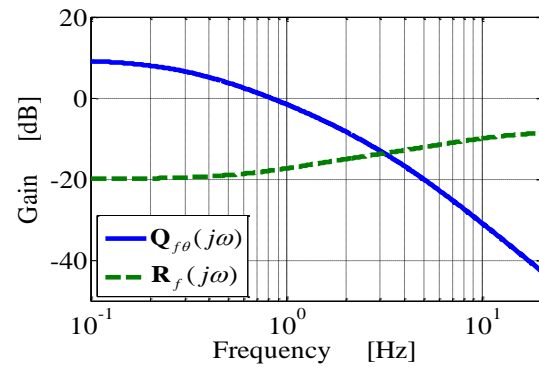

Fig. 6. Weighting functions for frequency shaped LQG

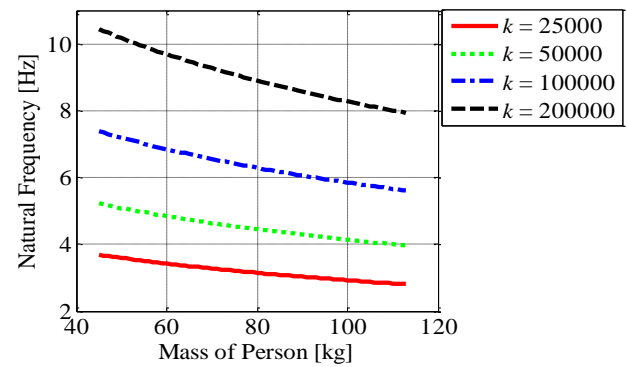

Fig. 7. Natural Frequency of the personal mobility

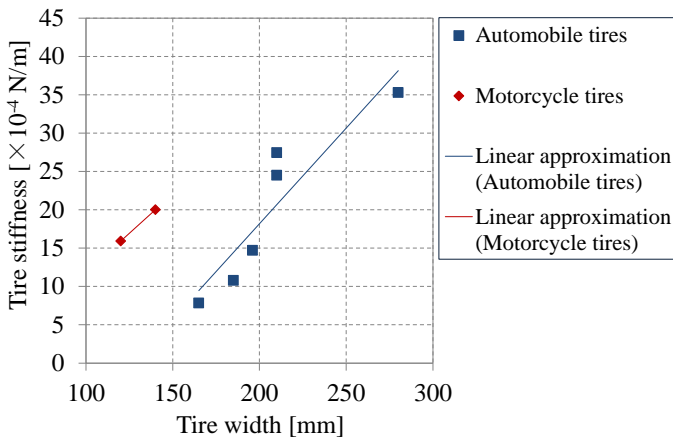
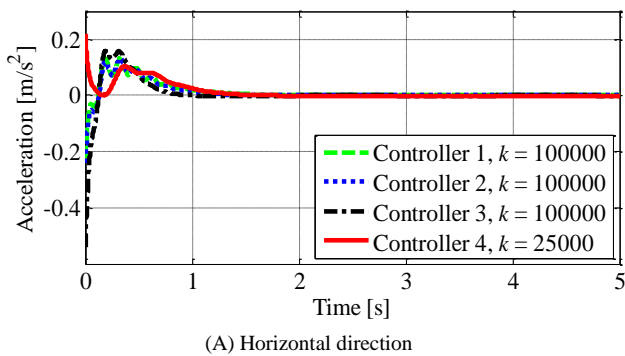
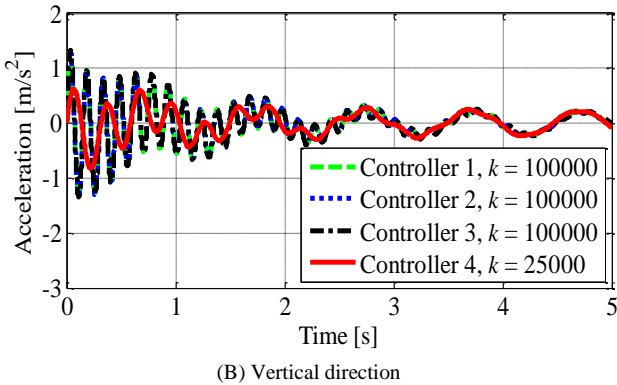

Fig. 8. Relations between the tire width and the stiffness



(A) Horizontal direction



(B) Vertical direction

Fig. 9. A rider's head acceleration (Sinusoidal road,  $f=1.0$  Hz)

Fig. 9 compares rider's head acceleration of Controller 1, Controller 2, and the proposed method. The road disturbance is sinusoidal ( $f = 1.0$  Hz). Fig. 10 and 11 show the results when the road disturbance is random (Level C) which simulate the actual road. Fig. 10 shows PSD of the head acceleration and Fig. 11 shows RMS of it. Based on the results in Chapter V, only Controller 1 and 2 are used in simulation for verification.

In Fig. 9(A), the proposed method does not modify the maximum value of the horizontal head acceleration. In Fig. 10(A), where the road disturbance is random, the vibration in the uncomfortable frequency range (0.8 - 1.6 Hz) is suppressed by the proposed method.

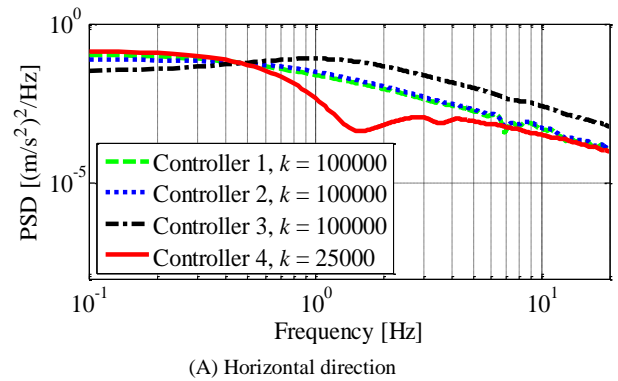

(A) Horizontal direction

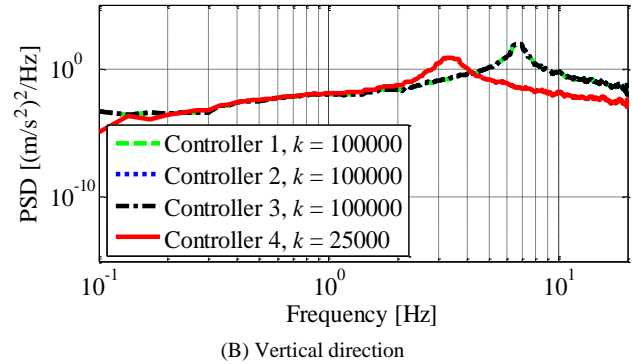

(B) Vertical direction

Fig. 10. PSD of a rider's head acceleration (Random road, Level C)

Fig. 11(A) shows that the RMS value of Controller IV is 13% smaller than that of Controller 2 which has the same settling time as Controller 4.

In Fig. 9(B), the proposed method suppresses the vertical head acceleration and makes the frequency of vibration lower. In Fig. 10(B), the peak of PSD moved from 6.7 Hz to 3.4 Hz, the natural frequency after tire changing. In Fig. 11(B), Controller 4 cannot suppress the RMS value. However, if the tire with the desired stiffness is combined with Controller 4, the RMS value is about 79% smaller than the value of others.

From these results, in both directions, the effectiveness of the proposed method was confirmed.

## VII. CONCLUSION

In this paper, we evaluated ride comfort of an inverted pendulum personal mobility (PM) and proposed a method to improve it. First, we suggested a model limited to two dimensions, horizontal and vertical, considering the tire stiffness. We assumed that the PM runs on a sinusoidal or random road and evaluated the horizontal and vertical vibration of the head of the occupant in numerical simulations. The evaluation methods are frequency analysis using PSD and RMS. We set the evaluation standard in accordance with ISO 2631-1. We proposed improvement methods for each direction. In the horizontal direction, we proposed frequency shaped LQG control. In the vertical direction, analysis showed that it is difficult to improve on the control system design approach. Therefore we proposed a change the tire as a hardware approach. Using both methods simultaneously, in the

REFERENCES

Horizontal direction, we reduced the vibration of the frequency range (0.8 - 1.6 Hz) in which human feels uncomfortable. At one time, in the vertical direction, the peak of PSD moved from 6.7 Hz, including within the uncomfortable frequency range (4.0 - 8.0 Hz), to 3.4 Hz, the natural frequency after tire changing. The results show that the proposed method was effective.

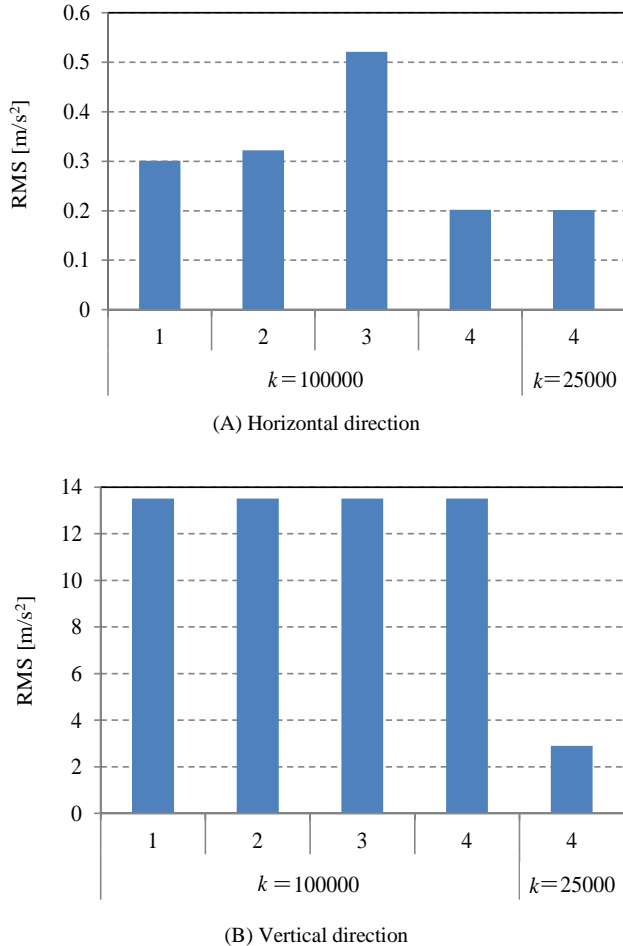

Fig. 11. RMS value of a rider's head acceleration (Random road, Level C)

As future works, we try to verify the validity of our proposed method through the simulations using the detailed model of occupant and the experiments using our developed inverted pendulum-type personal mobility.

- [1] Ministry of Internal Affairs and Communications, 2011. "The 2010 Census".
- [2] S. Arakawa, C. Nakagawa, A. Shintani and T. Ito, "Basic Study on the Behavior of Inverted Pendulum Vehicle and Driver Using Multibody Dynamics", Transactions of the JSME, vol. 78, no.789, pp.1497-1506, 2012 (in Japanese).
- [3] S. Ajisaka, T. Kubota and H. Hashimoto, "Human Balance Control Ability for Affinitive Personal Vehicle", 10th International Conference on Ubiquitous Robots and Ambient Intelligence (URAI), pp. 503-508, 2013.
- [4] C. Nakagawa, K. Nakano, Y. Suda and R. Hayashi, "Stability of the Dynamically Stabilized Two-Wheeled Vehicle Traveling on a Rough Road", Journal of Mechanical Systems for Transportation and Logistics, vol. 2, no. 1, pp. 78-89, 2009.
- [5] F. Grasser, A. D. Arrigo, S. Colombi and A. C. Rufer, "JOE: a Mobile, Inverted Pendulum", IEEE Transactions on Industrial Electronics, vol. 49, no.1, pp. 107-114, 2002.
- [6] G. C. Guerrero, J. J. R. Pasaye, "Real-time Control to Hold Upright Equilibrium of a Two-wheeled Auto-balancing Vehicle", Power, Electronics and Computing (ROPEC), IEEE International Autumn Meeting on Power, Electronics and Computing (ROPEC), pp. 1-5, 2013.
- [7] J. Huang, F. Ding, T. Fukuda, T. Matsuno, "Modeling and Velocity Control for a Novel Narrow Vehicle Based on Mobile Wheeled Inverted Pendulum," IEEE Transactions on Control Systems Technology, vol. 21, no. 5, pp. 1607-1617, 2013.
- [8] L. Zhijun, Y. Chenguang, "Neural-Adaptive Output Feedback Control of a Class of Transportation Vehicles Based on Wheeled Inverted Pendulum Models", IEEE Transactions on Control Systems Technology, vol. 20, Issue 6, pp. 1583-1591, 2012.
- [9] Segway Japan, Ltd., "Home Segway Japan", segway-japan.net. See also URL <http://www.segway-japan.net/index.html>, (accessed Jan, 2014).
- [10] Ministry of Education, Culture, Sports, Science and Technology, "Investigation of Physical Fitness and Exercise Capacity". See also URL [http://www.mext.go.jp/b\\_menu/toukei/chousa04/tairyoku/1261241.html](http://www.mext.go.jp/b_menu/toukei/chousa04/tairyoku/1261241.html), (accessed Jan, 2014)
- [11] R. S. Sharp, S. Evangelou, D. J. N. Limebeer, "Advances in the Modeling of Motorcycle Dynamics", Multibody System Dynamics, vol. 12, no. 3, pp. 251-283, 2004.
- [12] International Organization for Standardization ISO 8608, Mechanical vibration -Road surface profiles - Reporting of measured data, 1995.
- [13] International Organization for Standardization ISO 2631-1, Mechanical vibration and shock - evaluation of human exposure to whole-body vibration - part 1: general requirements, 1997.
- [14] L. Zuo, S. A. Nayfeh, "Low order continuous-time filters for approximation of the ISO 2631-1 human vibration sensitivity weightings", Journal of Sound and Vibration, 265, pp. 459-465, 2003.
- [15] N. K. Gupta, "Frequency-Shaped Cost Functionals: Extension of Linear-Quadratic-Gaussian Design Methods", Journal of Guidance, Control and Dynamics, vol. 3, no. 6, pp. 529-535, 1980.
- [16] Sakai, H., 1987. Tire Engineering, Grand Prix, 1-32 Kanda Jinbo-cho, Chiyoda-ku, Tokyo (in Japanese).
- [17] Kinetic Characteristics of Motorcycles and Environment Surrounding It, Society of Automotive Engineers of Japan, 1997.