

Analysis and Prediction of COVID-19 by using Recurrent LSTM Neural Network Model in Machine Learning

N.P.Dharani¹

Research Scholar, Department of Electronics and
Communication Engineering, Koneru Lakshmaiah
Education Foundation, Guntur, India
Sree Vidyanyethan Engineering College
Tirupati, Andhra Pradesh, India

PolaiahBojja²

Professor, Institute of Aeronautical Engineering
Hyderabad, TS, India
Koneru Lakshmaiah Education Foundation
Guntur, India

Abstract—As we all know that corona virus is announced as pandemic in the world by WHO. It is spreaded all over the world with few days of time. To control this spreading, every citizen maintains social distance and self preventive measures are the best strategies. As of now many researchers and scientists are continuing their research in finding out the exact vaccine. The machine learning model finds that the corona virus disease behaves in exponential manner. To abolish the consequence of this pandemic, an efficient step should be taken to analyze this disease. In this paper, a recurrent neural network model is chosen to predict the number of active cases in a particular state. To do this prediction of active cases, we need database. The database of COVID-19 is downloaded from KAGGLE website and is analyzed by applying recurrent LSTM neural network with univariant features to predict for the number of active cases of patients suffering from corona virus. The downloaded database is divided into training and testing the chosen neural network model. The model is trained with the training data set and tested with testing dataset to predict the number of active cases in a particular state here we have concentrated on Andhra Pradesh state.

Keywords—COVID-19; corona virus; KAGGLE; LSTM neural network; machine learning

I. INTRODUCTION

One of the journals Nature reported that these viruses are derived from unrecognized group called as corona virus and is identified by electron microscope. The full name of COVID-2019 is the Coronavirus disease of 2019, which has created panic in the whole world today. The total population of Andhra Pradesh in the year 2020 is 91,717,240 the people affected with the disease i.e., the confirmed cases are 4,45,139, the active cases of novel corona virus are 1,01,210 as of 2nd September, 2020 which has been taken from publicly available database [1]. All most all countries announced their states to lockdown in order to stop the travel of their citizens unnecessarily. Somehow the spreading of virus is controlled due to announcement of lockdown otherwise the spread of the disease is anonymous. Even though the economy of many countries was drastically dropped, the government announced lockdown. If anyone is found to be infected, she/he will be under quarantine for 14 days and treatment is given for

recovery. Base on the condition, it may cause death and many people gone to depression level. In India, the outburst of virus is disturbed the whole functioning life. At the starting stage, the cases are increased by transmission through local i.e., from person to person and later it is continued as the same [1]. The ways to detect corona virus by using rapid test kit, a portable device also detects virus in mucus membrane using a chip and a scanner and by taking a swab sample from patient's mouth or nose.

Till now there is no correct vaccine and anti-viral treatments are available and many medical organizations are trying hard to find out vaccine for COVID-19[2]. It is in our hands to save our lives from corona virus by providing personal protective equipments, masks and sanitization and maintaining social distance [3]. If we consider the present situation of COVID-19, the qualitative information is more prominent when compare with quantitative information. A best suited mathematical model is not able to predict the whole disease but, it may study the model to derive the nature of the disease. So, an appropriate machine learning/deep learning models are best suited to predict and study the nature and behavior of the whole disease shortly [4][5].

Artificial neural networks are very similar to our biological learning system that is interconnected with many several neurons in brain. ANN systems are provoked to confine this type of parallel computation based on distribution representations. To generate single valued output from real valued inputs, ANNs should be set up with a densely interconnected simple set of units. Here, interconnection is simply expressed as the means of processing the elements in neural network which are interconnected to one another [6]. So, the provision of all the elements and structure of connections are important in artificial neural network. Normally, we have three layers in ANN system. One is input layer where the inputs are feeding to the network and output layer, which generates outputs based on the inputs that we have provided to the system. The last and important layer is hidden layer where it acts as an interface between the input and the output layers. If we keep on increasing the hidden layers, the power required to process and computational speed can be increased and the entire system become complex.

Another class of ANN is recurrent neural network (RNN) [7]. The connections are formed between nodes and by a directed graph all along a series. This forms a dynamic behavior for a time series. These networks have feedback and form a closed loop. RNN also uses memory to process the series of inputs that we provided to the network. RNN have single layered recurrent network and multi layered recurrent network.

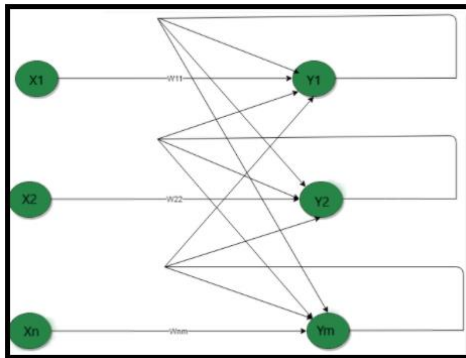

Fig. 1. Single Layered Recurrent Neural Network Model.

Fig. 1 is a network that represents a single layer network which provides a feedback connection in which each element of the node is given feedback to its own element or other element or can be to both.

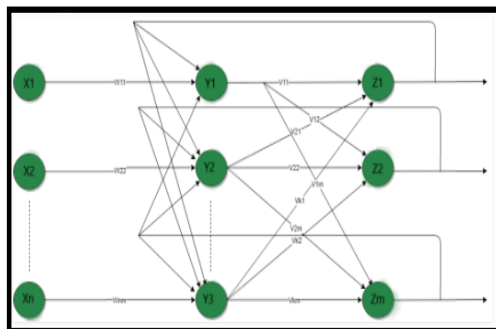

Fig. 2. Multi Layered Recurrent Neural Network Model.

Here, in Fig. 2, the multilayered network is shown; the output of the element is directed to the other element of the same layer and to the previous layer which forms a multi RNN. Both the elements perform the same operation and the output depends on the previous calculations so here no need to have inputs at each step. The computations of the series are captured in the hidden layer.

II. RELATED WORK

Lin Jia et al. analyzed three different types of mathematical models namely Bertalanffy, Gompertz and Logistic models. They applied these three models for different regions and found different parameters. With these parameters, they found Logistic model gives the outer performance among all the three models [7]. Narinder Singh Punn developed mathematical models like SVR, DNN, RNN and PR to find the RMSE and concluded that PR model gives the less RMSE value when compare with other models [8]. Sarbjit Singh et al. developed a hybrid model which involves

the decomposition of dataset into series of components by applying discrete wavelet function and then these components are applied to a suitable model named as ARIMA model for prediction of death cases for next one month across five countries [9].

LinhaoZhong et al. proposed a mathematical model for early prediction of number of infected cases by using SIR model with minimum parameters like recovered rate and infectious rate. Since the number of cases are exponentially increasing manner, quarantine measures need to be followed strictly and must pay attention towards the medical service [10]. UtkucanSahin et al. presented a model to forecast the number of confirmed cases in UK, USA and Italy. The authors studied a nonlinear grey Bernoulli model, grey model and fractional nonlinear grey Bernoulli model to predict confirmed cases. In their study fractional nonlinear grey Bernoulli model offers the best performance of providing lowest MAPE, RMSE and R^2 values [11]. Lixiang Li et al. proposed suitable model to compare the official data and model predicted data and found the error is very small [12]. NaliniChintalapudi et al. presented a model using R statistics to forecast the registered and recovered cases [13]. Debanjan Parbat et. al. utilized SVR model for prediction of total number of recovered, death, confirmed cases and found the accuracy of the model along with MSE and RMSE [14]. SalihDjilaliet.al. presented a mathematical model to predict the spread of the disease transmission [15]. Patricia Melinet. al. proposed a neural network multi ensemble model with fuzzy response for the corona virus time series data to get valid and accurate predicted values [16]. Zlatan Car, Sandi BaressiSegota et al proposed a neural network model of multilayer perceptron to find R^2 values for recovered, confirmed and death cases [17].

III. DATASETS AND METHODOLOGY

A. Dataset Description

In this analysis, the COVID-19 data was downloaded from KAGGLE site. There are different source to get the data for analysis which includes: (1) john Hopkins (<https://corona.virus.jhu.edu/>); (2) KAGGLE (<https://www.kaggle.com/sudalairajkumar/covid19-in-india>); (3) CDC (<https://www.cdc.gov/library/researchguides/2019novelcoronavirus/researcharticles.html>); (4) data hub (<https://datahub.io/core/covid-19>); (5) Tableau (<https://www.tableau.com/covid-19-coronavirus-data-resources>) and soon. With these websites any researcher can download the datasets which is his/her interest and can do analysis. The data we have taken from 30 January, 2020 to 2 September 2020 which consists of confirmed, death, cured/migrated cases of all over India. But in this research article, we concentrated on only the state Andhra Pradesh. The dataset of daily reported cases are summarized in a table in the form of XLSX or CSV format with the parameters like confirmed, deaths, cured/migrated cases. These datasets are taken in this paper for analysis and prediction of active cases especially in Andhra Pradesh.

B. Methodology

The corona virus in India spreads due to local transmission from one person to other person easily at the earliest stage.

The expert person has to diagnose at the earliest stage and can control the spread of the disease. With the objective of forecasting the possibility of transmission among citizens, we developed a recurrent neural network model. This system model utilizes long short term memory (LSTM) cell [18]. To develop this, machine learning and deep learning library packages like pandas, numpy, matplotlib, seaborn, sklearn and math are imported into jupyter notebook to analyze confirmed, death cases and also to predict active cases of Andhra Pradesh (AP).

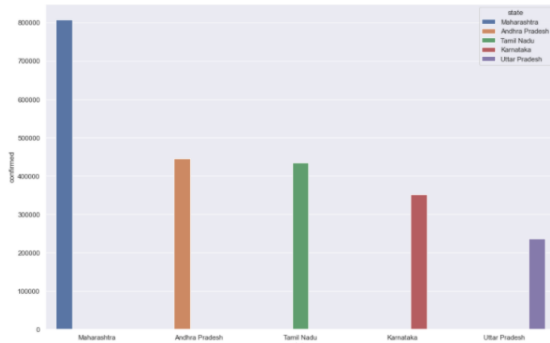

Fig. 3. Bar Plot of Top 5 States of Confirmed Cases.

The plot shown in Fig. 3 provides the information of confirmed cases where Maharashtra is in top position, Andhra Pradesh stood second position and fifth place is Uttar Pradesh. Similarly, if we consider top death cases, the below Fig. 4 shows the bar pot of states with top death cases.

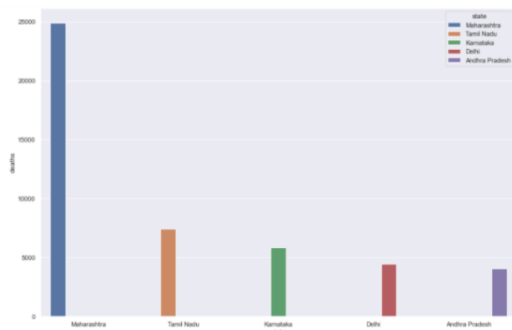

Fig. 4. Bar Plot of States with Top Death Cases.

Now if we consider the total number of confirmed cases, death cases and active cases in Andhra Pradesh. Plot the line graph with the data available in CSV file, we get the graphs that was shown in Fig. 5, 6 and 7, respectively:

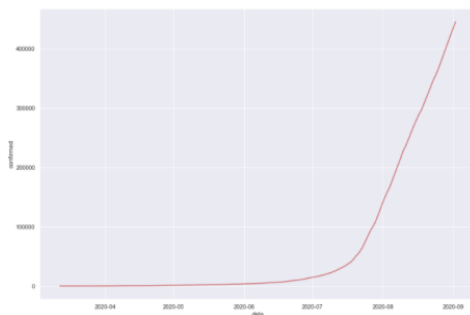

Fig. 5. Plot of Confirmed Cases in AP.

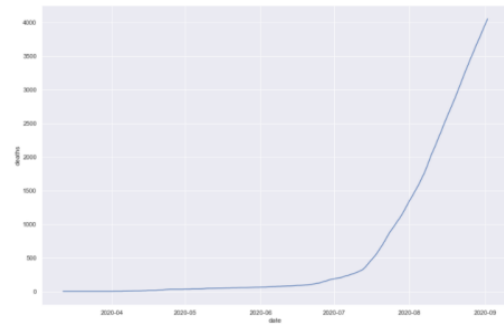

Fig. 6. Plot of Deaths Cases in AP.

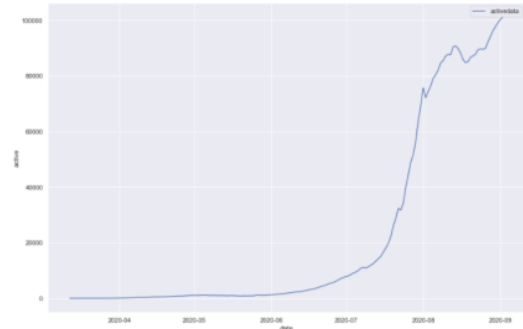

Fig. 7. Plot of Active Cases in AP.

IV. IMPLEMENTATION OF ALGORITHM

A conventional neural network is having just a bunch of parallel layers which consists of nodes called as neurons. These neurons are interconnected to each other and forms layers from which data transmits from one layer to the next layer. This first layer is named as input layer, last layer is called as output layer and between layers are named as hidden layers [19]. A set of neural networks known as recurrent networks which deals with the time series data. These networks have memory to process the previous data that is transferred through the network. But the RNN experiences from short term memory. While computing gradients during back propagation, when the gradients become very small and they will not add up large amount of learning. Therefore RNN stops learning since they get very small gradients. Hence these RNN when it is seen in longer series networks won't learn much and thus have very short memory. To eliminate this short memory, LSTM should incorporate a mechanism inside the network known as gates and controls the stream of data that pass through the nodes and thus eliminates the short memory. The implementation of corona virus forecasting is based on the long short-term memory (LSTM) networks by taking one feature into account at a time [20] [21].



Fig. 8. LSTM Single Time Series Feature Model.

Fig. 8 represents an LSTM model which is a type of RNN and especially used to predict the time series patterns as well as classification problems. Since our dataset is time series, we have chosen this model for prediction. This model may take last 8 day's features and forecasts the figures for the 8th day. When the target value reaches, it stops and exists; it takes into account its predictions.

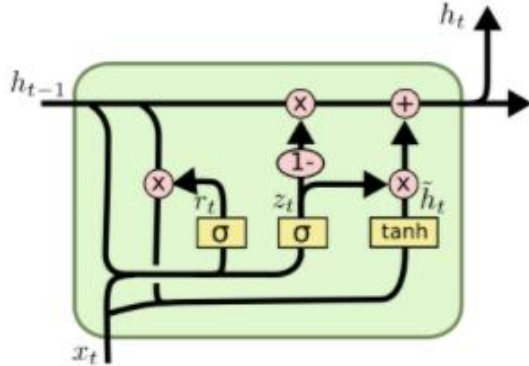

Fig. 9. LSTM Model with its Activation Function.

The LSTM model shown in Fig. 9 merges the forget gate and input gate into one gate. It also joins the cell state and hidden states. The number of nodes or neurons is chosen in trial and error method to give best results. The most common method is k-fold cross validation. The formula is expressed below to find number of nodes:

$$N_h = \frac{2}{3}(N_i + N_o) \quad (1)$$

Where N_i is the input neurons and N_o is the output neurons.

The outputs of the respective gates are given below:

$$\begin{aligned} Z_t &= \sigma(W_z \cdot [h_{t-1}, X_t]) \\ r_t &= \sigma(W_r \cdot [h_{t-1}, X_t]) \\ \tilde{h}_t &= \tanh(W \cdot [r_t * h_{t-1}, X_t]) \\ h_t &= (1 - z_t) * h_{t-1} + z_t * \tilde{h}_t \end{aligned} \quad (2)$$

1) Procedure of Neural Network1:

- a) Import required library packages.
- b) Read data which is saved in .csv format.
- c) Filter the data by choosing required state here Andhra Pradesh has been chosen.
- d) Line plot of confirmed cases of AP.
- e) Line plot of death cases.
- f) Divide the train, test data and also define number of epochs, batch size, number nodes, activation function and optimizer.
- g) Train the network model by using fit function and plot the graph of training and predicted values.
- h) Find out the performance metric like RMSE, MSE, MAE, SSE.

The loss of one layer in LSTM model is very high. To get best output, we need to add one more layer by adding nn2.add instruction.

2) Procedure of Neural Network Layer2

- a) Add the model as sequential.
- b) Add one more layer and one dense layer and repeat the compilation of nn2 to find the performance metrics.
- c) Here also all the metrics shows higher values.
- d) To reduce the metrics values, we have to convert the time series to stationary since the input we applied is dynamic time series and is not repeating.

3) Procedure to Find the Difference:

- a) Find the series of difference for the given time series as: $d_1 = L_1 - L_0, d_2 = L_2 - L_1, \dots, d_N = L_N - L_{N-1}$.
- b) From there, find $L_1 = L_0 + d_1, L_2 = L_1 + d_2, \dots, L_N = L_{N-1} + d_N$.
- c) Find cumulative series by finding $d_k = L_k - L_0, d_{k+1} = L_{k+1} - L_1, \dots, d_N = L_N - L_{N-k}$.
- d) Plot the graph of difference active cases.
- e) Again find the difference of difference of difference of active cases since, the difference we calculated in step 3 may be iterative.
- f) Compute the metrics of difference of difference of difference of active cases.
- g) Plot the graph of difference of difference of difference of active cases.

4) Procedure to Find the Scaling Transformation:

- a) First reduce the dataset into fixed interval.
- b) Use the activation function linear from 0 to 1 which eliminates negative values.
- c) Apply scaling transformation to the difference of active cases.
- d) Apply this value to third layer of LSTM model to train and to find performance metrics.
- e) Plot the actual series of active cases.

V. SIMULATION RESULTS

A. Performance Analysis

The performance parameters are analyzed to evaluate the neural network model called Mean Absolute Error, Mean Square Error, Root Mean Square Error and Sum of Squared Error and their definitions along with equations are shown below. The definitions of the performance metrics are shown along with equations [22]:

1) *Mean absolute error*: The ratio of sum of differences of all predicted values and tested values to the total length of tested values. The formula to compute MAE is given below [22] [23] [26]:

$$MAE = \frac{\sum_{N=1}^n |Actual - Predicted|}{N} \quad (3)$$

2) *Mean square error*: The mean of difference squared between the actual and predicted values. It is expressed as [22][24]:

$$MSE = \frac{\sum_{N=1}^n |Actual - Predicted|^2}{N} \quad (4)$$

3) *Root mean square error*: Root mean square error is used to compute the residual errors. These residual are measured by finding how the values are away from the line of regression. RMSE is the ratio of square root of summation of squared deviation of actual and predicted values to the number of actual values [25].

$$RMSE = \sqrt{\frac{\sum_{N=1}^n |Actual - Predicted|^2}{N}} \quad (5)$$

4) *Sum of square error*: It is defined as the sum of difference squared between all the actual and predicted values. The equation of sum of squared error is given by the formula [23]:

$$SSE = \sum_{N=1}^n |Actual - Predicted|^2 \quad (6)$$

The neural network model is trained with appropriate dataset to predict the active case in AP and computed the performance metrics.

B. Graphical Representation of Active Cases in Andhra Pradesh

Fig. 10 represents the data and predictions of active cases in AP.

Fig. 11 plots the data of predictions of active cases that was taken from second neural network model. Fig. 12 provides information of data after taking difference of active cases.

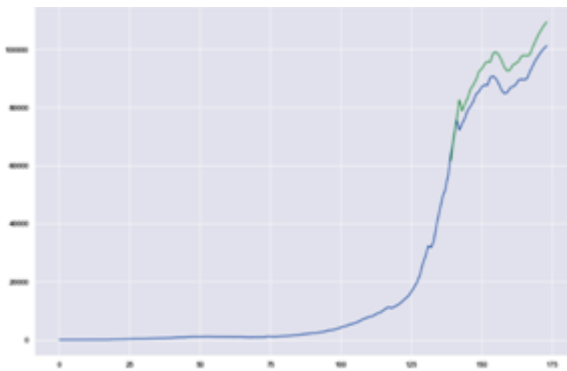

Fig. 10. Plot of Data and Predictions of Active Cases in AP.

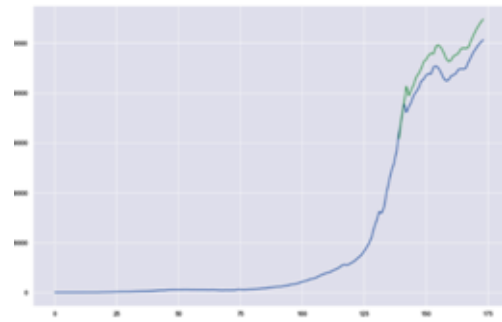

Fig. 11. Plot of Predictions of Active Cases from Second Neural Network Layer.

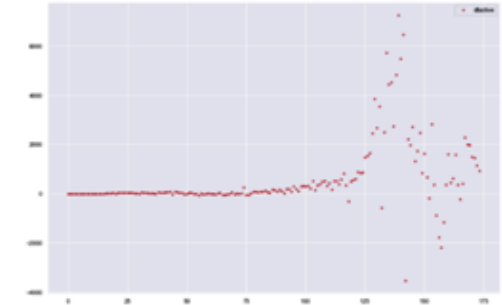

Fig. 12. Plot of Difference of Active Cases in AP State.

Fig. 13 provides information of 3 differences in active cases and analyzed that data has now become statistic instead of dynamic.

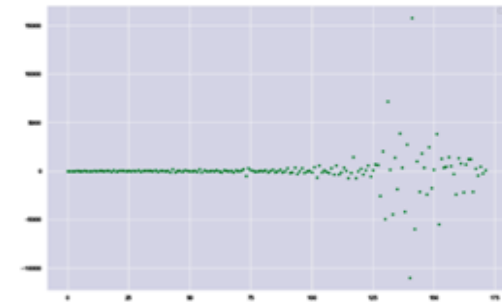

Fig. 13. Plot of 3 Differences of Active Cases in AP.

Fig. 14 represents graph of training and predicting data of active cases in Andhra Pradesh.

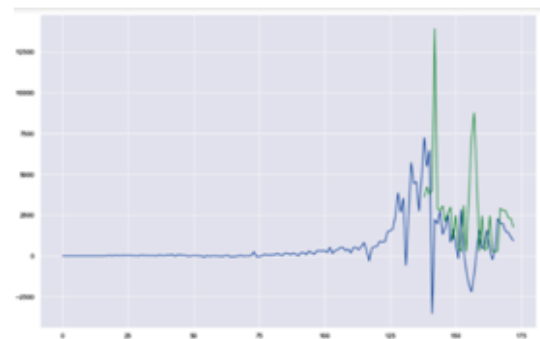

Fig. 14. Plot of Loss for Training Data and Predicting Data of Active Cases in AP.

Fig. 15 shows the actual series of the active cases in Andhra Pradesh.

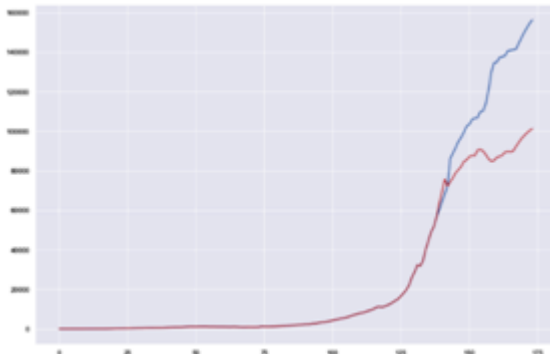

Fig. 15. Plot the Actual Series of Active Cases in AP.

Fig. 16 represents the active cases after scaling down to reduce the loss.

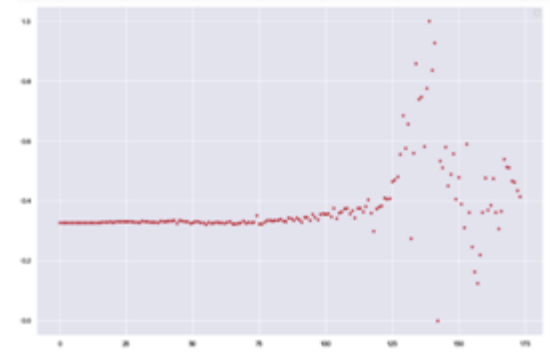

Fig. 16. Plot of Active Cases after Difference Scaling.

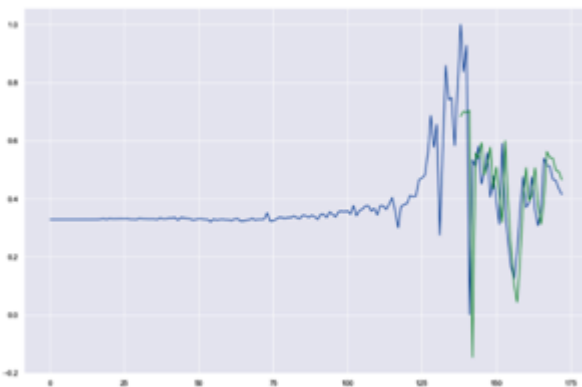

Fig. 17. Plot of Training Data and Predicting Data of Difference Scaling of Active Cases in AP.

Fig. 17 represents the information of training and predicting data of difference scaling of active case in Andhra Pradesh state.

Fig. 18 shows the actual series of cases and the predicted cases and provides the information of deviation from actual to prediction values.

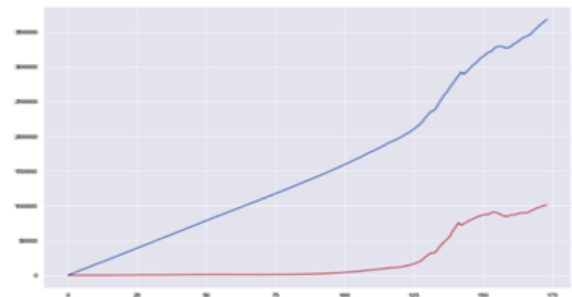

Fig. 18. Plot of Actual Series of Cumulated and Predicted Active Cases in AP.

All the performance metric values are tabulated in Table I.

TABLE I. SUMMARY OF PERFORMANCE METRIC VALUES OF THE NEURAL NETWORK MODEL

S. No	Performance metrics	Values
One layer in LSTM model		
1.	Loss	49385091.59
2.	RMSE	3151.79
3.	MAE	1187.86
4.	SSE	1728478205.76
Second layer of NN		
6.	Loss	50219150.41
7.	RMSE	3178.29
8.	MAE	1197.85
9.	SSE	1757670264.37
Difference of active cases		
11.	Loss	18699324.54
12.	RMSE	1945.02
13.	MAE	730.94
14.	SSE	654476359.02
Third layer of NN (Scaling Transformation)		
16.	Loss	0.04
17.	RMSE	0.09
18.	MAE	0.03
19.	SSE	1.49

We tabulated the actual values and predicted values of active cases in Andhra Pradesh in Table II for the next 25 days.

TABLE II. ACTUAL AND PREDICTED VALUES OF ACTIVE CASES

S.No.	Actual Values	Predicted Values	S.No.	Actual Values	Predicted Values
1.	1	1	2.	1	1453
3.	1	2907	4.	1	4359
5.	1	5812	6.	1	7265
7.	2	8719	8.	3	10172
9.	3	11625	10.	5	13080
11.	7	14535	12.	8	15989

13.	8	17441	14.	10	18896
15.	11	20350	16.	13	21805
17.	18	23262	18.	22	24719
19.	39	26189	20.	82	27686
21.	84	29140	22.	130	30640
23.	159	32122	24.	188	33604
25.	222	35091	26.	262	36584
27.	296	38072	28.	338	39567
29.	350	41032	30.	364	42499
31.	364	43952	32.	414	45455
33.	450	46944	34.	478	48425
35.	500	49900	36.	522	51375
37.	546	52853	38.	546	54305
39.	610	55823	40.	639	57305
41.	669	58788	42.	727	60300
43.	781	61807	44.	859	63339
45.	835	64767	46.	911	66297
47.	970	67810	48.	1014	69307
49.	1051	70797	50.	1027	72226
51.	1027	73678	52.	1062	75167
53.	1090	76648	54.	1092	78103
55.	1092	79555	56.	1012	80927
57.	1029	82397	58.	1004	83824
59.	999	85272	60.	1010	86736
61.	998	88177	62.	988	89619
63.	948	91032	64.	965	92502
65.	1007	93997	66.	953	95395
67.	901	96795	68.	872	98218
69.	859	99658	70.	909	101161
71.	885	102590	72.	891	104049
73.	892	105503	74.	911	106975
75.	1158	108677	76.	1105	110077
77.	1056	111480	78.	1067	112944
79.	1150	114480	80.	1220	116004
81.	1268	117505	82.	1341	119032
83.	1413	120558	84.	1546	122145
85.	1613	123666	86.	1654	125160
87.	1817	126778	88.	1951	128367
89.	2031	129900	90.	2191	131515
91.	2292	133070	92.	2301	134532
93.	2495	136181	94.	2688	137830
95.	2765	139360	96.	3052	141104
97.	3244	142751	98.	3340	144301
99.	3637	146055	100.	3948	147822
101.	4240	149571	102.	4562	151350
103.	4766	153009	104.	5284	154986
105.	5428	156585	106.	5760	158374
107.	6145	160217	108.	6648	162179
109.	7164	164154	110.	7479	165926
111.	7897	167802	112.	8071	169431

113.	8586	171406	114.	9096	173375
115.	9473	175210	116.	10043	177240
117.	10860	179520	118.	11200	181317
119.	10894	182460	120.	11383	184408
121.	11936	186421	122.	12533	188478
123.	13428	190837	124.	14274	193147
125.	15144	195481	126.	16621	198430
127.	18159	201440	128.	19814	204569
129.	22260	208499	130.	26118	213859
131.	28800	218028	132.	32336	223062
133.	31763	223935	134.	34272	227929
135.	39990	235173	136.	44431	241123
137.	48956	247159	138.	51701	251392
139.	56527	257733	140.	63771	263017
141.	69252	268331	142.	75720	273704
143.	72188	279086	144.	74404	275554
145.	76377	279574	146.	79104	283388
147.	80426	287791	148.	82166	290972
149.	84654	294572	150.	85486	298805
151.	87112	301436	152.	87773	304926
153.	87597	307352	154.	90425	308678
155.	90780	313147	156.	89907	315187
157.	88138	315508	158.	85945	314478
159.	84777	312813	160.	85130	312692
161.	86725	314730	162.	87177	318190
163.	87803	320354	164.	89389	322736
165.	89742	326188	166.	89516	328225
167.	89932	329481	168.	92208	331600
169.	94209	335669	170.	96191	339507
171.	97681	343329	172.	99129	346684
173.	100276	349996	174.	101210	352988

VI. CONCLUSION

Corona virus pandemic occurred in all over the world. By applying LSTM neural network model, we predicted the growth of active cases of Andhra Pradesh. If we observe the plot of actual series and predicted series, it is still showing exponential behavior. Every citizen need to follow preventive measures to avoid and controlling the spread of virus. This analysis shows the predicted values and performance metrics like MAE, MSE, RMSE and SSE values. Up on observation among all the mentioned metrics the third layer offers minimum error values with the LSTM model of 3 layers with 10 nodes. If we increase computing of difference between the active cases, we get the errors to minimum value.

VII. DATA AVAILABILITY

The data used to support the findings of this study are available from the corresponding author upon request.

VIII. FUNDING

This research has been no funds received for this research work.

IX. CONSENT

Informed consent was obtained from all individual participants included in the study.

X. CONFLICTS OF INTEREST

The authors declare that they have no conflicts of interest. Authors' Contributions All authors equally contributed to the study conception and design and implementation of the research, analysis and interpretation of results, and manuscript preparation.

ACKNOWLEDGMENT

The authors are thanks to Koneru Lakshmaiah Education Foundation, Guntur for providing the support and Characterization of completing this work.

REFERENCES

- [1] R. Sujath, et al., A machine learning forecasting model for COVID-19 pandemic in India, *Stochastic Environmental Research and Risk Assessment*, <https://doi.org/10.1007/s00477-020-01827-8>, May, 2020.
- [2] Organization W.H.O, et al. Q&A on coronaviruses. 2020b.
- [3] Parul Arora, et al., Prediction and analysis of COVID-19 positive cases using deep learning models: A descriptive case study of India, *Chaos, Solitons and Fractals*, 139, 2020.
- [4] Ramjeet Singh Yadav, Data analysis of COVID-2019 epidemic using machine learning methods: a case study of India, *International Journal of Information Technology*, <https://doi.org/10.1007/s41870-020-00484-y>, May, 2020.
- [5] ManotoshMandal, et al., A model based study on the dynamics of COVID-19: Prediction and control, *Chaos, Solitons and Fractals*, 136, May, 2020.
- [6] Najmul Hasan, A Methodological Approach for Predicting COVID-19 Epidemic Using EEMD-ANN Hybrid Model, *Internet of Things*, 11, May, 2020.
- [7] Jia, YuKang, et al. Long Short-Term Memory Projection Recurrent Neural Network Architectures for Piano's Continuous Note Recognition. *Journal of Robotics*, 2017.
- [8] Narinder Singh Punn, et al., COVID-19 Epidemic Analysis using Machine Learning and Deep Learning Algorithms, *Medrxiv*, 2020.
- [9] Sarbjit Singh, et al., Development of new hybrid model of discrete wavelet decomposition and autoregressive integrated moving average (ARIMA) models in application to one month forecast the casualties cases of COVID-19, *Chaos, Solitons and Fractals*, 135, 2020.
- [10] Linhao Zhong, et al., Early Prediction of the 2019 Novel Coronavirus Outbreak in the Mainland China Based on Simple Mathematical Model, *IEEE access*, vol. 8, 2020.
- [11] Utkucan Sahin and TezcanSahin, Forecasting the cumulative number of confirmed cases of COVID-19 in Italy, UK and USA using fractional nonlinear grey Bernoulli model, *Chaos, Solitons and Fractals*, 138, 2020.
- [12] Li, Lixiang, et al., Propagation analysis and prediction of the COVID-19. *Infectious Disease Modelling*, vol. 5, pp. 282-292, March, 2020.
- [13] Lin Jia, et al., Prediction and analysis of Coronavirus Disease 2019, *Arxiv*, 2020.
- [14] Chintalapudi, Nalini & Battineni, Gopi & Amenta, Francesco. (2020). COVID-19 virus outbreak forecasting of registered and recovered cases after sixty day lockdown in Italy: A data driven model approach. *Journal of microbiology, immunology, and infection*, <https://doi.org/10.1016/j.jmii.2020.04.004>. vol. 53, pp.396-403, April 2020.
- [15] Parbat, Debanjan, and Monisha Chakraborty. "A python based support vector regression model for prediction of COVID19 cases in India." *Chaos, Solitons & Fractals*, 138, 109942, May, 2020.
- [16] Melin, Patricia, et al., Multiple ensemble neural network models with fuzzy response aggregation for predicting COVID-19 time series: the case of Mexico. *Healthcare*. vol. 8. no. 2. Multidisciplinary Digital Publishing Institute, pp. 1-13, June 2020.

- [17] Car, Zlatan, et al., Modeling the Spread of COVID-19 Infection Using a Multilayer Perceptron. *Computational and Mathematical Methods in Medicine*, May, 2020.
- [18] Shastri, Sourabh, et al., Time series forecasting of Covid-19 using deep learning models: India-USA comparative case study, *Chaos, Solitons & Fractals*, 140, 110227, 2020.
- [19] Islam, Md Zahirul, Md Milon Islam, and Amanullah Asraf., A combined deep CNN-LSTM network for the detection of novel coronavirus (COVID-19) using X-ray images. *Informatics in Medicine Unlocked*, 20, 100412, 2020.
- [20] Pal, Ratnabali, et al., Neural network based country wise risk prediction of COVID-19, *arXiv preprint arXiv: 2004.00959*, 2020.
- [21] Liu, Fenglin, et al., Predicting and analyzing the COVID-19 epidemic in China: Based on SEIRD, LSTM and GWR models, *Plos one* 15.8, e0238280, 2020.
- [22] N.P.Dharani et al., Detection of Breast Cancer by Thermal Based Sensors using Multilayered Neural Network Classifier, *International Journal of Engineering and Advanced Technology*, vol. 9 Issue. 2, pp.5615-5618, Dec. 2019.
- [23] C Venkatesh and PolaiiahBojja, Development of Qualitative Model for Detection of Lung Cancer using Optimization, *International Journal of Innovative Technology and Exploring Engineering*, vol. 8 Issue.9, pp. 3143-3147, July 2019.
- [24] C Venkatesh and PolaiiahBojja, A Novel Approach for Lung Lesion Segmentation Using Optimization Technique, *Helix*, vol. 9, no. 1, pp. 4832.
- [25] C Venkatesh and PolaiiahBojja, A Novel Approach for Lung Lesion Segmentation Using Optimization Technique, *Helix*, vol. 9, no. 1, pp. 4832.
- [26] Dharani, N P et al. "Evaluation of Performance of an LR and SVR models to predict COVID-19 Pandemic." *Materials today. Proceedings*, 10.1016/j.matpr.2021.02.166. 16 Feb. 2021, doi:10.1016/j.matpr.2021.02.16.

AUTHORS' PROFILE



Mrs. N.P.Dharani received her M.Tech degree in Electronics and Communication Engineering with specialization of Digital Systems and Computer Electronics from Balaji Institute of Technology and Sciences, Warangal, affiliated to JNTUH, Hyderabad and received B.Tech degree in Electronics and Instrumentation Engineering from Sreenivasa Institute of Technology And Mngement Studies, Chittoor, affiliated to JNTUH, Hyderabad. She is pursuing Ph.D at K L E F Deemed to be University, Vaddeswaram, Guntur, Andhra Pradesh, India. Her area of research is Image/signal Processing, Prediction and Machine Learning/Deep Learning. She has published nine International journals and attended National and International Conferences. She is a life member of International Association of Engineers (IAENG).



POLAIAH BOJJA is presently working as Professor in department of Electronics and communication Engineering, K L E F Deemed to be University, Vaddeswaram, Guntur, Andhra Pradesh, India. He obtained B.Tech from JNTU, Hyderabad. M.Tech from Annamalai University, Tamil Nadu and Ph.D from JNTU Anantapuramu, Andhra Pradesh. He is a principal Investigator for the projects funded by AICTE, New Delhi and DeitY, New Delhi and Collaboration with C-DAC, Thiruvananthapuram. His overall teaching experience is 16 Years. He was published papers in International and National reputed journals with scopus/SCI Indexed and also overall presented conferences in National and International are more than 85. His research interests include Signal Processing and Embedded control systems and also Process Modelling, Optimization, Prediction, Adaptive Optimal Control, Automation, Machine Learning and Computing for Engg., applications. He is a Life Member's of International Society for Technology in Education (ISTE) and (Indian Science Congress Association (ISCA), Member of Automatic Dynamic Controller for systems (ADCS) and International Association of Engineers (IAENG). He has published two text book in Digital image Processing for Industrial Applications and twopatents. He acted as reviewer for many IEEE international conferences and also delivered keynote speech in various conferences and Organizations.