

# Green ICT Readiness Model for Developing Economies: Case of Kenya

Mr. Franklin Wabwoba,

Department of Information Technology  
Kibabii University College

Dr. Gregory W. Wanyembi,

Department of Computer Science  
Masinde Muliro University of Science and Technology

Dr. Stanley Omuterema,

Department of Disaster Management and Sustainable  
Development  
Masinde Muliro University of Science and Technology

Mr. Kelvin Kebati Omieno

Department of Computer Science  
Masinde Muliro University of Science and Technology

**Abstract**— There has been growing concerns about the rising costs of doing business and environmental degradation world over. Green ICT has been proposed to provide solutions to the two issues yet it is not being implemented fully in developing economies like Kenya. For its implementation, it is critical to establish the level of green ICT readiness of organisations to inform where to start and where to put more emphasis. Over the past few years this has been done using Molla's G-readiness model. However this model assumes the basic level of G-readiness to be same for both developed and developing economies to be the same with regard to ICT personnel preparedness. Based on green ICT readiness in Kenya, the relationship between ICT personnel's gender, age and training with the G-readiness variables as proposed in Molla's G-readiness model was investigated. The study surveyed ICT personnel in four cases using a questionnaire on a seven scale likert scale. It established that there exists a significant relationship between the ICT personnel related variables and the G-readiness variables. Based on the findings on the relationship, the study extended Molla's G-readiness model to include a sixth dimension of personnel readiness.

**Keywords**— *Developing economies; Extended G-readiness model; Green ICT; G-readiness model; Green ICT readiness*

## I. INTRODUCTION

This Organisation preparedness to implement green ICT may require answering a number of questions to determine the likelihood of doing it successfully. As noted by Molla & Cooper (2009) [1], in an environment where other change initiatives are perceived to have been well-managed, people were as involved as they wanted to be, communication infrastructure and process are already in place, with previous change projects being seen as successful and with clear success factors having been articulated, green ICT is likely to be implemented successfully.

Green ICT readiness is considered to be an organization's capability to embed sustainability in the beliefs and attitudes in the development, deployment and disposal of ICT technical assets and in their ICT processes, practices and policies and in the governance systems to ensure compliance with internal and external sustainability expectations [2]; [3]. Therefore

We appreciate the National Council of Science and Technology (Kenya) for funding the PhD research "Enhancing green ICT through ICT personnel alignment in developing economies" from which this paper was developed.

green ICT readiness or G-readiness is demonstrated through the combination of attitude, policy, practice, technology and governance in applying environmental criteria to its ICT technical infrastructure across the key areas of ICT sourcing, operations and disposal to solve both ICT and non-ICT by using IT related sustainability problems [4]. This however cannot be achieved without the ICT personnel's valuable contribution.

## II. AN OVERVIEW OF MOLLA'S G-READINESS MODEL

The G-Readiness model's by Molla, Cooper, & Pittayachawan (2009) [4] was adopted for this study. Green ICT readiness in the study therefore was addressed from five dimensions namely: - attitude, policy, practice, governance and technology but following analysis of personnel factors an extension of a sixth dimension of the human capability was introduced. The initial model approach is given in the Figure 1.

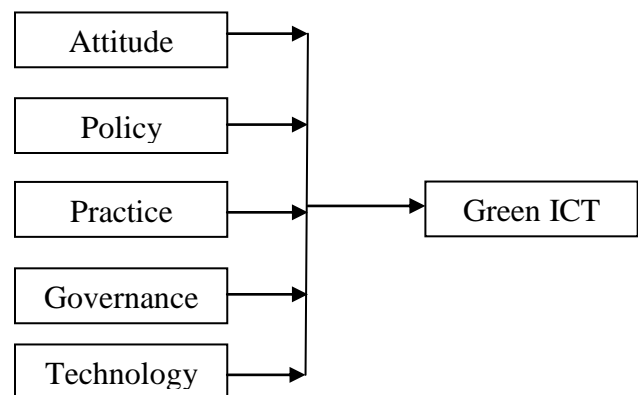

Figure 1: Green ICT readiness model

Source: Molla, Cooper, & Pittayachawan (2009) and Cooper & Molla (2012)

### A. Green ICT Attitude

Attitude is an intangible thing. It describes how we think, rather than how we act, and it is about attitude or culture [5]. Green ICT Attitude deals with the extent to which ICT people and management are aware of and concerned about climate change and the environmental impact of ICT artifacts and operations [6]. The Green ICT Attitude does reflect the

disposition of the ICT people and management within any given organisation to the issue of climate change and to the anticipated role of ICT in organizational strategy to respond to such change towards sustainability. It may define the level of ICT professionalism [7]. Naturally this is reflected in the ICT organizations effort to improve the energy efficiency in managing the ICT technical infrastructure with a view of reducing greenhouse gas emissions and e-waste.

Attitude in this study was considered to be an organisation's ICT people sentiments, values and norms towards climate change and eco-sustainability and ICT's role [2]. Having a positive attitude towards Green ICT is very important – it precedes everything else [5]. And, as is often the case in business, those attitudes are most effective if they come from the managerial human infrastructure. “Managerial human personnel support is an essential part of any Green ICT program [1]. Attitude has been established to be one of the major factors that influence the acceptance and use of technologies hence will most likely have a major influence on the implementation of green ICT. Please do not revise any of the current designations.

### B. Green ICT Policy

Green ICT Policy encompasses the frameworks an organization has developed and put in place to apply environmental sustainability criteria throughout its value chain including ICT sourcing, ICT operations and services and ICT end-of-life management [6]; [8]. Policy defines the administration of green ICT initiatives, the allocation of budget, and other resources as well as the metrics for assessing its impact [2]. A policy development framework includes the establishment of policies, the communication of those policies, the enforcement of those policies, and the measurement of policy effectiveness and mitigation strategies [5]. A green ICT policy takes into account the required roles and responsibilities, skill-sets, commitments, targets, deliverables and methodologies used. The policies give indication on the organisation's commitment to technology redundancy and the roll-over in gaining benefits of each technology advance that is taking place rapidly.

It does encompass the frameworks an organisation puts in place to apply environmental criteria green ICT activities and operations [4]. This measure determines how organisations have advanced their green ICT initiatives. Green ICT readiness policies are those that discourage environmental negative impacts such as energy intensive production methods, wasteful packaging, poor recycling practice and heavy use of hazardous materials use and practices. The main areas for assessment of policy readiness according to Molla and Cooper (2009) are IT sourcing, IT operations and services and IT end of life management.

Some operations and services policy considerations are inclusive of computer power management, computer use policies for the staff. This includes of policies that guide the extent to which services provided by ICT support issues of sustainability [1].

IT end of life policy are policies and regulations that guide disposal and settlement of ICT infrastructure. They have

guidelines on how to deal with end life of equipment such as how to recycle them or how to do away of the same.

It is essential for organisations to have and follow the National Plan and National ICT policy as well as organisational policy on green ICT. In so doing they will have set of their goals to employ green ICT in the future. Such a plan may positively affect enhancement of green ICT because the human personnel especially the ICT trainers may prepare themselves and learners for the future by changing their behaviour so as to increase the utilization green ICT.

### C. Green ICT Practice

Aside from having written policies, organisations have to make the policy work. This is attained through ICT practices. ICT practices are the actual application and realization of eco-sustainability considerations in ICT infrastructure sourcing, operations and disposal [2]. Molla and Cooper (2009) observe that it is possible for an organization to have policies in place and yet not have the same actualised. Green ICT Practice refers to the extent an ICT organization has translated its Green ICT concerns and policies into actions along the ICT activity value chain [1]. This is the actual application and realization of eco-sustainability considerations in ICT infrastructure sourcing, operation and disposal [9]. In particular, the sourcing and ICT infrastructure design and energy consumption audit and monitoring are important sub-components of Green ICT practice are components to pay attention to. The main areas for assessment of practice readiness according to Cooper and Molla (2009) are IT sourcing, IT operations and services and IT end of life management.

Policies can be made to work using several approaches such as setting green ICT goals to achieve, performing regular monitoring using the set matrix, having ICT personnel to champion green ICT, auditing the activities undertaking among other tasks. Green ICT sourcing practice readiness entails evaluating the environmental behaviour of suppliers, advocating of green technologies, and shortening of ICT infrastructure refresh periods.

Green ICT operation practices involve people, clients, and servers among other ICT infrastructure [1]. It deals with issues related to clearly articulate green guidelines for buying ICT equipment and services and adoption of environmental friendly purchases being undertaken [10]. These may be determined through assessing how the organisations operate existing ICT systems in an energy efficient manner, audits the power efficiency of existing ICT systems and technologies, enforces personal computer power management, analyses ICT's energy bill separately from overall corporate bill, implements ICT projects to monitor the organisation's carbon footprint, engages with a professional service provider regarding green ICT, and retires energy inefficient systems.

According to Molla & Cooper (2009:15), green ICT end of life management practice is the “compliance of IT equipment/machinery manufactures, users, and sellers in green IT end of life management.” It has got to do with establishing whether ICT infrastructure as well as its packaging is reusable especially if their crushing or burning could harm the

environment [11]. This may be actualised through recycles consumable equipment, disposes ICT equipment by returning it to suppliers, and disposes of ICT equipment in environmentally friendly manner and employing energy efficient coding. The principle behind energy efficient coding is to save power by getting software to make less use of the hardware, rather than continuing to run the same code on hardware that uses less power.

#### D. Green ICT Technology

Green ICT Technology refers to technologies and information systems for (a) reducing the energy consumption of powering and cooling corporate IT assets (such as data centers) (b) optimizing the energy efficiency of the IT technical infrastructure (c) reducing IT induced greenhouse gas emissions (d) supplanting carbon emitting business practices and (e) analyzing a business's total environmental footprint" [2]; [4]. From this perspective it may be said to reflect the extent to which the organizations acquire and build a more environmentally effective ICT infrastructure. This involves technologies and information systems for reducing the energy consumption of powering and cooling of ICT assets; optimizing the energy efficiency of the ICT technical infrastructure; reducing ICT induced greenhouse gas emissions; supplanting carbon emitting business practices; and analyzing a business's total environmental footprint [12]; [13]. The major question is "how to organisations use their ICT infrastructure?"

According to Cooper & Molla (2010), green ICT technology readiness may be measured by assessing the extent to which an organisation has green business infrastructure and green power sources, development of green ICT standards across the enterprise, server consolidation and virtualization, extent that applications and technologies are retired for greener technologies and extent of solutions development to support enterprise wide green initiatives.

As organisations institute their technology infrastructure they can employ a number of green ICT infrastructure technologies. With the continuous demand for ICT use in the developing economies as they strive for an e-economy there is an increased utilisation of servers. At the same time there is increased demand for servers following increased demand for networking, storage, speed, computation, backups and recovery which result in increased demand for energy and release of green houses gases [14]. However as they do this about 30% of the servers are dead just consuming power without being utilised therefore increasing costs of conducting business [15]. Green ICT utilisation comes in handy to reducing costs and green house gases emission.

#### E. Green ICT Governance

Green ICT Governance is the operating model that defines the administration of Green ICT initiatives and is closely related to the policy dimension [9]. It refers to the ICT management capability to put in place environmental criteria and frameworks to guide the sourcing, use, and disposal of the ICT technical infrastructure and activities of ICT personnel [2]. Effective ICT governance is the most important predictor of the value of an organisation generates from ICT [16]. According to Weill and Ross (2005), it is the practice that

allocates decision rights and establishes the accountability framework for ICT decisions. And according to Schmidt & Kolbe (2011) therefore green ICT governance specifies the decision rights and accountability framework to encourage environmentally desirable behaviour in the sourcing, use and disposal of ICT. It is needed to establish clear roles, responsibilities, accountability and control of Green IT initiatives. For this to be achieved the roles responsibilities, accountability and control for green ICT initiatives need to be clearly established [4].

Well established responsibility structures on the matter may thus be a very good indicator of the organisations green ICT preparedness. It also implies allocating a budget for actualizing green ICT and putting in place metrics for establishing the impacts of green ICT initiatives [6]. In creating such structures the human personnel plays a major role. It has to provide sound management decision to understand impacts, prioritize actions and manages the enterprise's responses as required to implement successful Green ICT initiatives [4]. It is ICT technical human personnel that align ICT with the organisation goals. But this has to be done in line with what the managerial human personnel has set.

No single governance approach may be applied across organisations in line with green ICT [17]. This is entirely because specific external and internal factors of a given organisation, derivation from organisational settings, regulatory markets, socio-cultural, ecological, and technological environments are unique to each organisation [18] and often does influence the organisation's actions and this are directed by the human infrastructure. How the human personnel perceives the importance or uncertainty of green ICT determine the level of implementation of green ICT in the given organisation [19]. Every organisation attempts to encourage different behaviours [17] majorly dependents upon the managerial human personnel equipment with the necessary green ICT skills, a fact the model fails to consider. Without paying special attention to the managerial infrastructure therefore implies minimal chances of green ICT being successfully applied. Governance also involves change management, knowledge management, strategic planning and alignment and policies [20]; [21].

For governance to be actualize green ICT, it has to have clear structures in place where the role for coordinating green ICT initiatives are defined and the CEO plays a leading role in green ICT initiatives. It provides for responsibilities are clearly defined within each green ICT initiative which necessitates establishment of metrics for assessing the impact of green ICT initiatives and setting targets to reduce the organizations carbon footprint. Governance would realise much where ICT department is responsible for its own electricity bill.

### III. METHOD

The study surveyed four cases that included a leading sugar manufacturing factory in the country that has invested into intensive application of ICT in virtually all its operations, a university that offers training programs in Information technology starting from certificate all the way to doctoral

level, a communications commission involved in the regulatory tasks of information and communications technology in the country and senior government officers. From the four cases respondents were selected based on the involvement in ICT use. They consisted of top management, ICT technical uses, postgraduate (MSc and PhD) level students and senior government officers. The postgraduate students consists of a combination of information technology lecturers, ICT managers and ICT technical works in various companies and government departments in the country.

The study used a combination of questionnaire, interview and observation to collect data. This was complimented with secondary data from literature. The questionnaire used a seven scale for responses ranging from strongly disagree taking the value of 1 and being the lower most while strongly agree was the highest with the value 7. The neutral value had been assigned a value of 4. The respondents ranked their level of agreement with provided statements on the scale of seven (1. Strongly disagree 2. Disagree 3. Fairly disagree 4. Neutral 5. Fairly agree 6. Agree 7. Strongly agree).

#### IV. FINDINGS OF THE STUDY

Green ICT readiness was assessed from five dimensions namely attitude, policy, practice, governance and technology

maturity levels which is presented in this section (5.1). The relationship between the five dimensions of green ICT readiness and the ICT personnel characteristics in the study presented as demographics is also presented in this section (5.2).

##### A. Green ICT readiness in Kenya

The study found that the green ICT attitude level of organisations was very low in Kenya as compared to other countries such as the USA, New Zealand and America. For example, the study found the pervasiveness of green ICT within Kenya as at 2012 in comparison to other countries in the world such as Australia, New Zealand and USA as at 2009 and Indonesia as at early 2012 to be what is presented by Figure 2.

##### 1) Green ICT readiness in Kenya

The study found that the green ICT attitude level of organisations was very low in Kenya as compared to other countries such as the USA, New Zealand and America. For example, the study found the pervasiveness of green ICT within Kenya as at 2012 in comparison to other countries in the world such as Australia, New Zealand and USA as at 2009 and Indonesia as at early 2012 to be what is presented by Figure 2

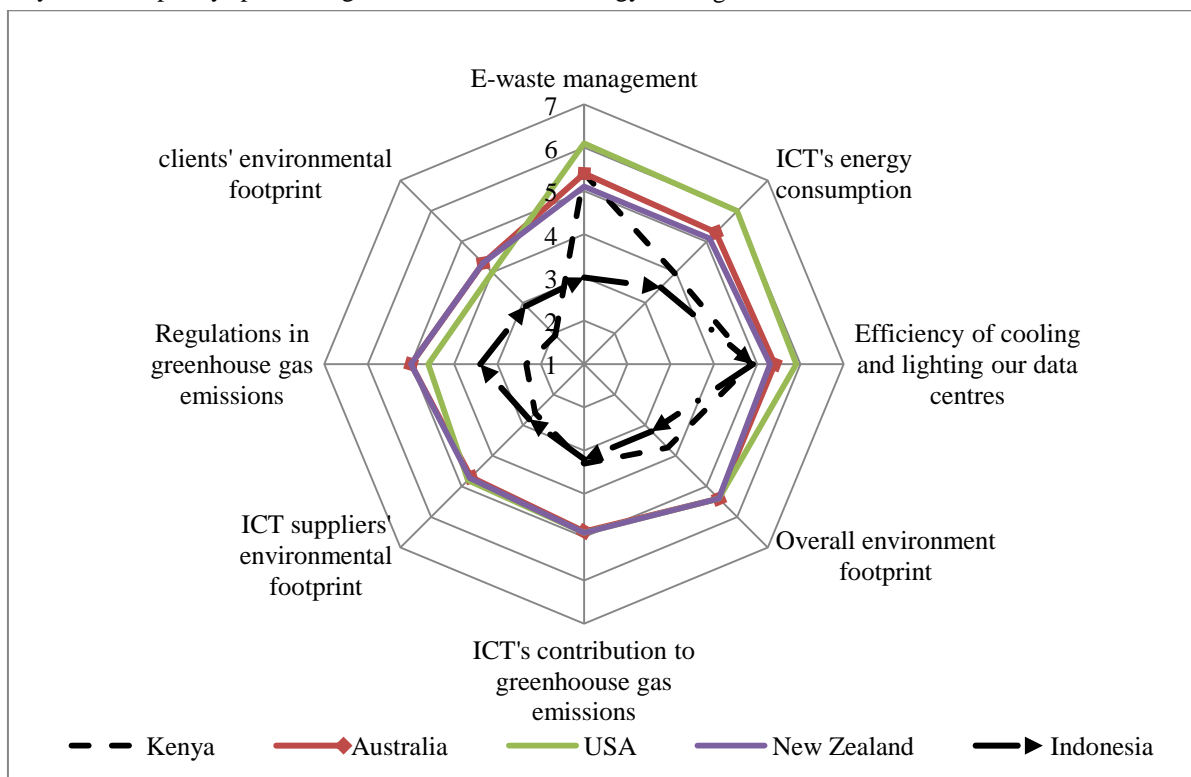

Figure2: Pervasiveness green ICT awareness an international perspective

Sources: Molla et al, 2009; Mariani & Imam, 2012; Field data 2012

From the findings presented in Figure 2, it is observable that the pervasiveness of green ICT awareness in Kenya is relative same as that of Indonesia except for e-waste concern. Kenya appears to be at the same level with Australia and New Zealand. Otherwise on the rest of the awareness aspects, Kenya is fairly below where Australia, USA and New Zealand

were in 2009. There is need therefore deliberate effort to raise the awareness levels and have green ICT implemented. As the country works towards sustainability in its vision 2030, there is more to be done with regard to technology use than adopting it. It will be prudent to realize that excessive use of technology is not the way for achieving economical and

technological development but the use of such technologies should be coupled with sound planning to ensure minimal adverse effects on the natural environment [23]. Sustainability is critical in ICT use hence the need to implement green ICT.

The Policy maturity level for Kenya in comparison to the USA, New Zealand, Australia and Indonesia is presented in Figure 3.

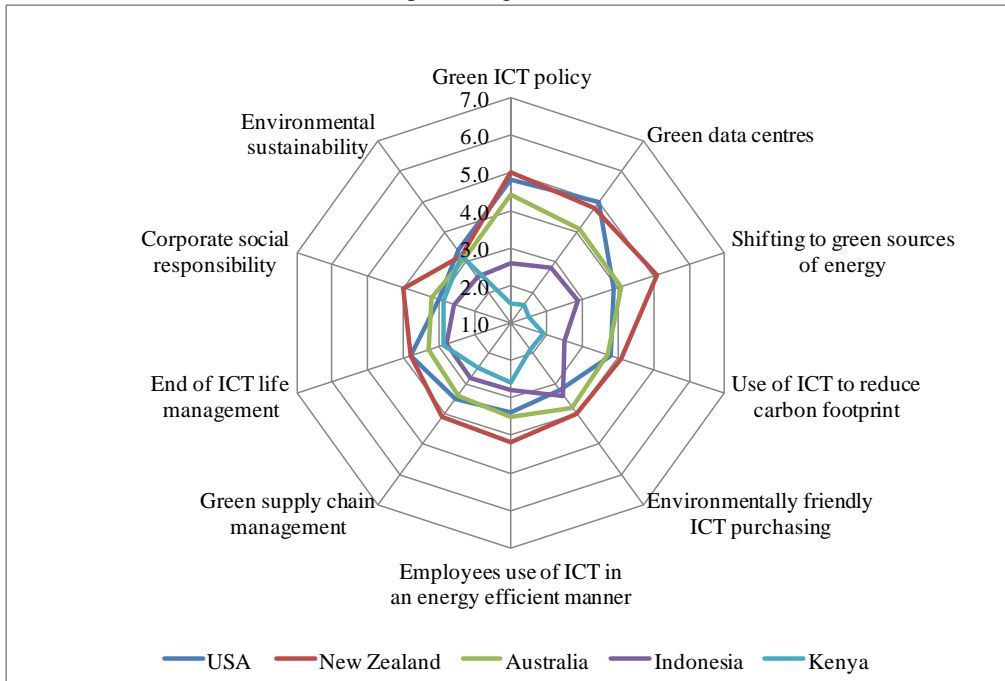

Figure 3: A comparison of countries green ICT policy maturity levels  
Sources: Molla et al, 2009; Mariani & Imam, 2012; Field data 2012

From Fig. 3, it is clear that the green ICT policy maturity levels for developing economies (Kenya and Indonesia) are lower than those of the middle and developed economies (USA, Australia and New Zealand). The curves of Kenya and Indonesia are fairly closer to the value 1 being the lowermost scale point.

The practice maturity level was assessed through the sourcing maturity level and the operations maturity level. The findings of the sourcing maturity are presented in figure 4.

Figure 4 clearly shows that the sourcing maturity of Kenya and Indonesia is much lower as compared to USA, New Zealand and Australia. The curves of Kenya and Indonesia are inside those of the other countries. The operations maturity level findings are presented in Figure 5.

As can be seen from Figure 5, the operations maturity of Kenya and Indonesia are much lower as compared to USA,

New Zealand and Australia. The curves of Kenya and Indonesia are inside those of the other countries. On the overall therefore Kenya's and Indonesia's practice maturity level is lower than that of the USA, New Zealand and Australia.

The technology maturity level was assessed via green infrastructure technologies and green data centre physical infrastructure maturity level. The findings are presented in Figure 6 and Figure 7.

On the dimension of governance, the findings of the study are presented in Figure 8.

Figure 6 shows that the maturity level of green ICT infrastructure technologies is low for Kenya and Indonesia as compared to the USA, Australia and New Zealand. On the other hand Figure 7 presents the data centre physical infrastructure maturity findings

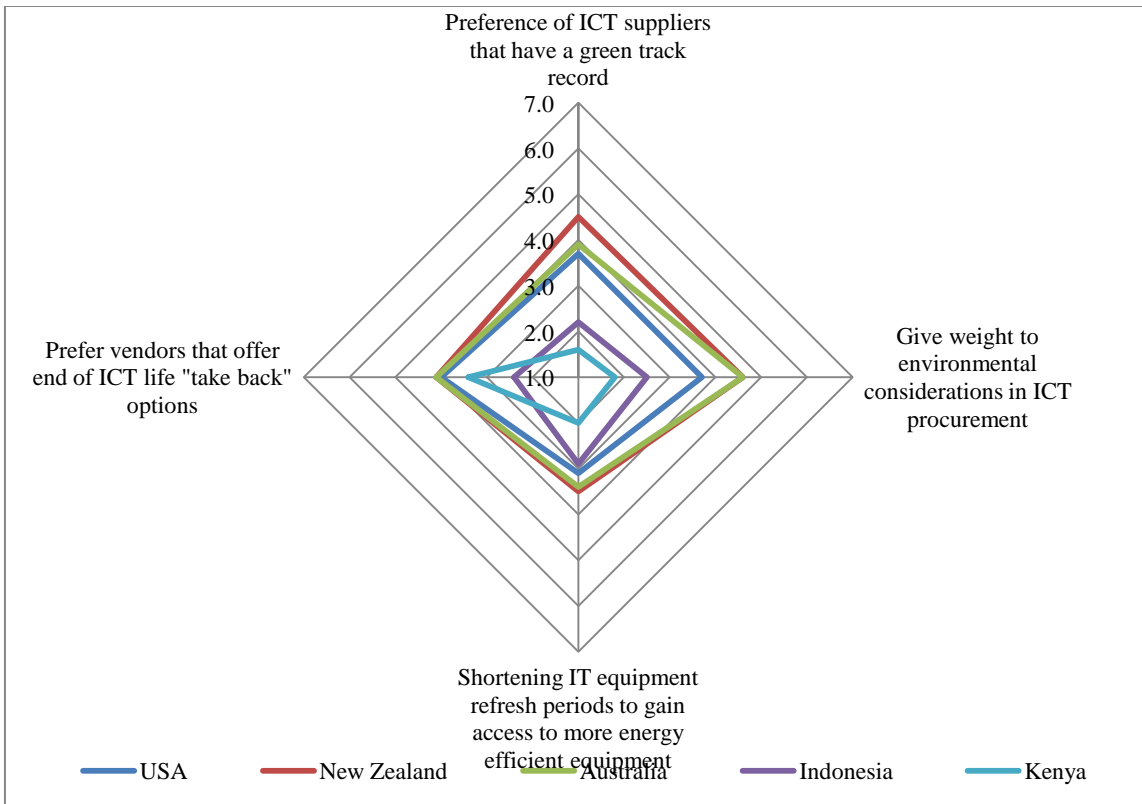

Figure 4: Countries comparison of green ICT sourcing maturity level  
Sources: Molla et al, 2009; Mariani & Imam, 2012; Field data 2012

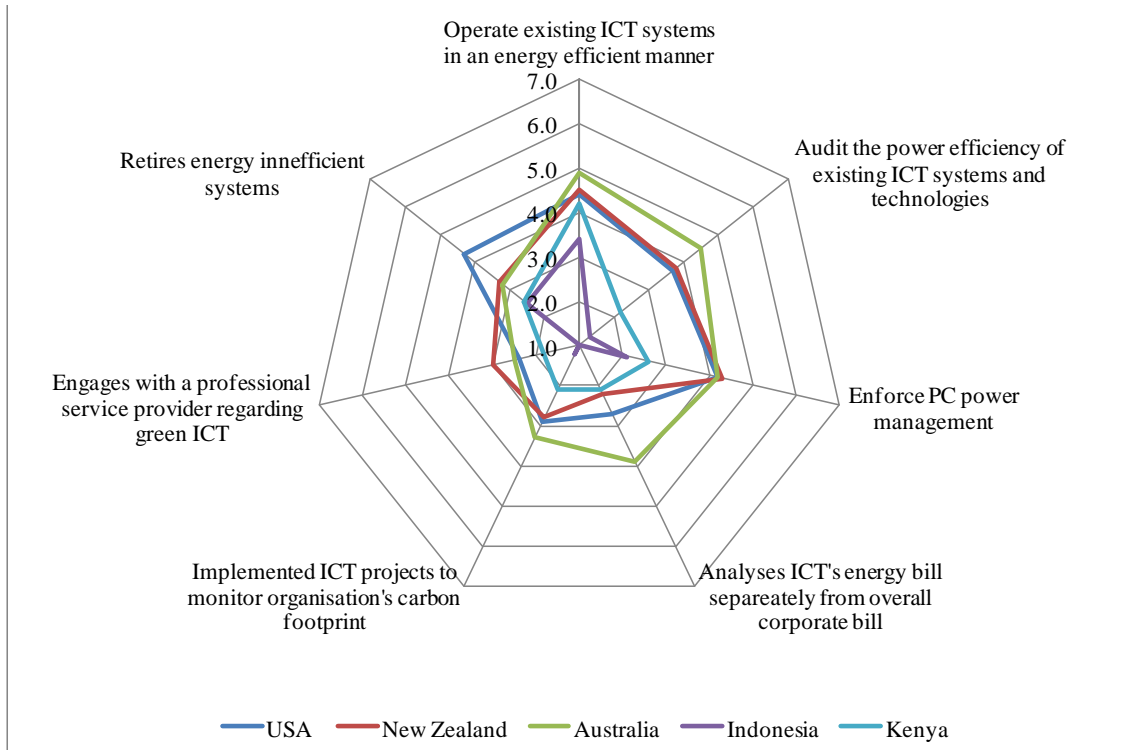

Figure 5: Countries comparison of green ICT operations maturity level  
Sources: Molla et al, 2009; Mariani & Imam, 2012; Field data 2012

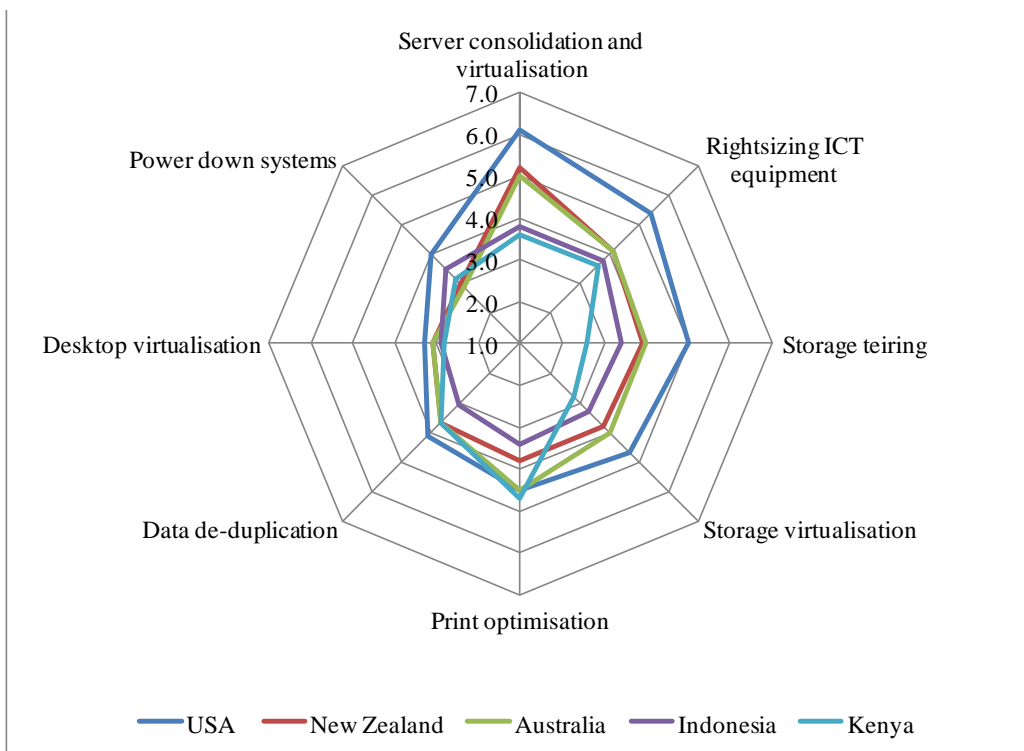

Figure 6: Countries comparison of green ICT infrastructure technologies maturity level  
Sources: Molla et al, 2009; Mariani & Imam, 2012; Field data 2012

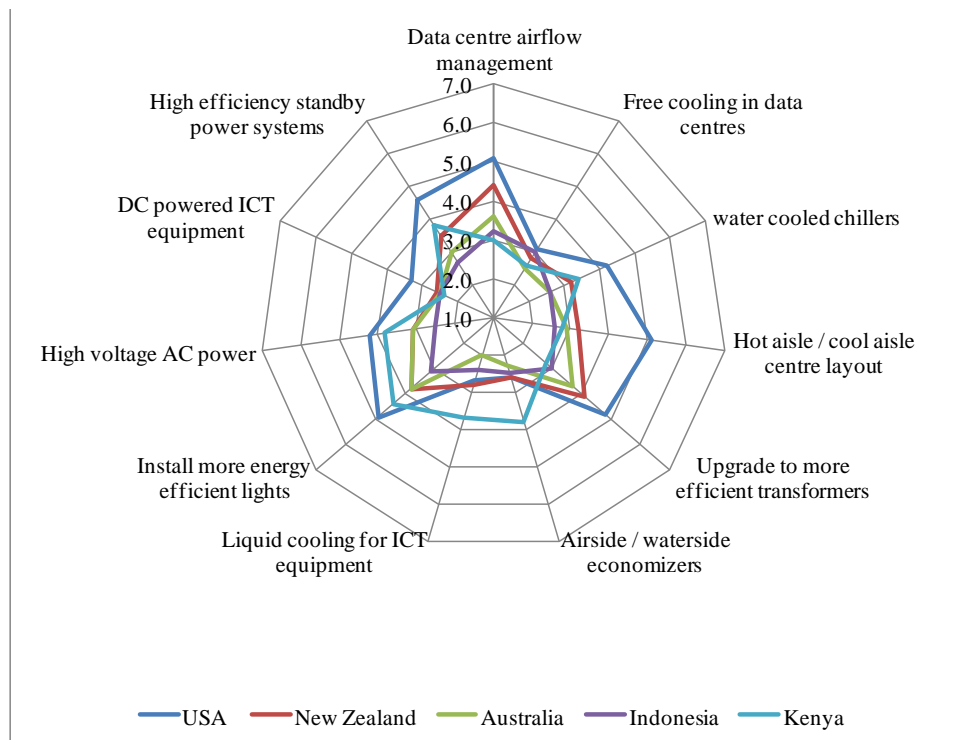

Figure 7: Countries comparison of green ICT data centre physical infrastructure maturity level  
Sources: Molla et al, 2009; Mariani & Imam, 2012; Field data 2012

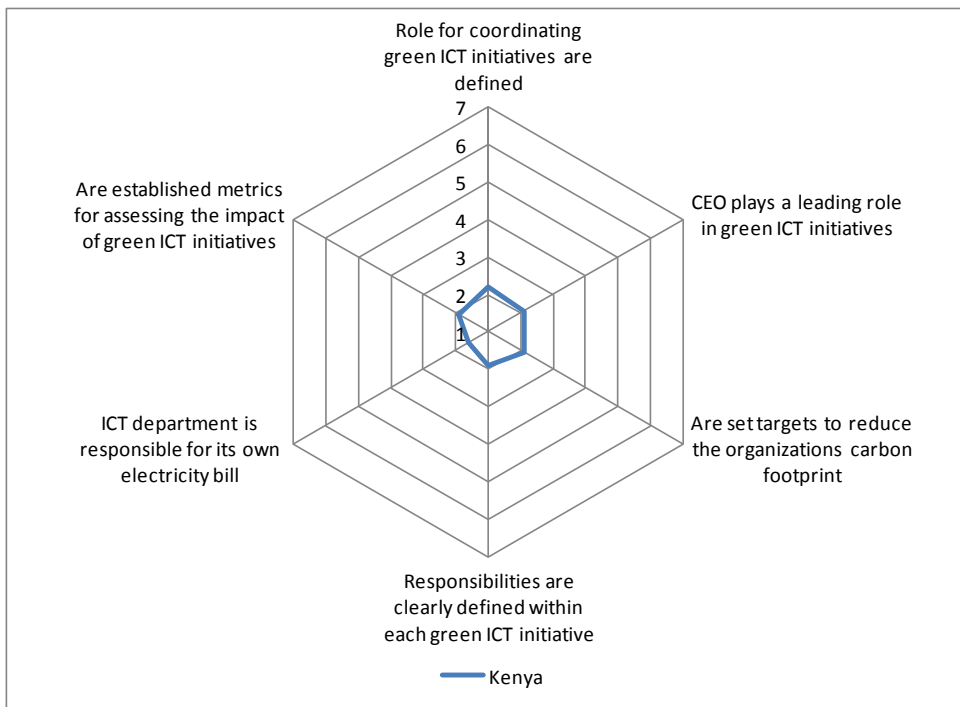

Figure 8: Green ICT governance maturity level in Kenya  
Sources: Field data 2012

The green ICT governance level in Kenya is very low. The highest value on all aspects assessed is just slightly above 2 on a scale of 7. This clearly indicates that governance structures are fairly not in place or green ICT is yet to be given the attention it deserves.

The G-readiness level being low in all dimensions led to attempt to answer the question why it was lower in the developing economies as compared to middle and developed economies. This led establishing the relationships that existed between the personnel characteristics that were considered within the demographics of the study and the different dimensions of green ICT readiness.

**B. Relationships between demographics and green ICT readiness dimensions**

This section gives an overview of the findings of the ICT personnel characteristics who were involved in the study in section 5.2.1 and their relationship with the five dimensions of green ICT readiness following Molla et al model of G-readiness in section 5.2.2.

**1) Demographics**

The respondents for the study came from different sector and gender therefore had some basic characteristics that are explained in this section. The characteristics include age, gender, sector of work, occupation, academic qualifications and technical qualifications.

Figure 9 gives the findings on respondent's age.

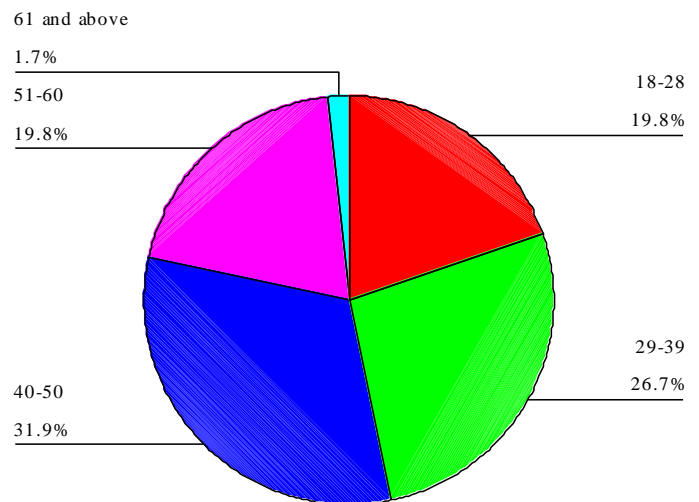

Figure 9: Respondents distribution based on age

From Figure 9 only 1.7% of the respondents were 61 years and above in age while 19.8% were of age between 51 and 60. In the age bracket of 40 to 50 there were 31.9% of the respondents with 26.7% being of age between 29 to 39 years. Only 19.8% of the respondents were of age between 18 to 28 years. Most of the respondents are of age between 29 to 50 years constituting 57.5%. The age set in employment therefore is equally distributed across the board however there are very few employees with over 50 years working within the ICT area.



This could be probably due to training in the field not having been there in the country in the earlier years. ICT is a young field in the developing nations like Kenya.

These respondents of the various ages were distributed across different occupation levels within their organisations. Figure 10 presents the findings of distribution of occupational levels amongst the respondents.

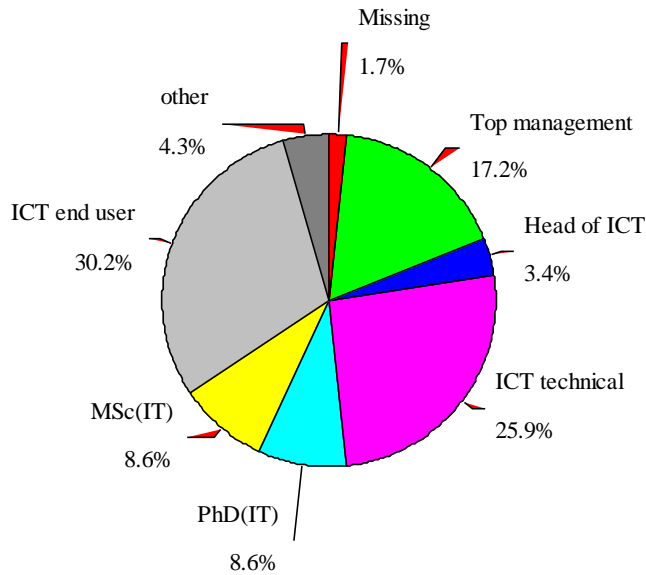

Figure 10: Respondents distribution based on their occupation

As can be seen from Figure 10, 1.7% the respondents did not indicate the occupation. Top management respondents constituted 17.2%. Top management play the critical of directing the organisations focus. The heads of ICT sections within the organisations made up 3.4% only. The ICT technical personnel constituted 25.9% of the respondents. The heads of ICT sections and the technical personnel are the key personnel in implementing ICT innovations. The end users who actual utilise or actualise the implemented technologies constituted 30.2%. The MSc (IT) and PhD (IT) students made up 17.2%. They were also composed of a selection of ICT professionals from different sections some of who ICT managers, lecturers and consultants. Since end users form the majority of the ICT personnel, there is need to have them to be made highly aware and equipped with green ICT skills if the implementation is to be enhanced.

Despite the different professions that were held by respondents, they were all either male or female with the gender findings being presented in Figure 11.

From Fig. 11, only 31% of the respondents were female with the rest, 69%, being male. Though the percentage of the female respondents is low, it's worth noting that they are above one third. As compared to others sectors, the ladies seem to be doing fairly better in the ICT sector. However there is need to improve further the number of appropriately qualified ladies employed within the sector.

The respondents had diverse academic training levels as presented in Figure 12.

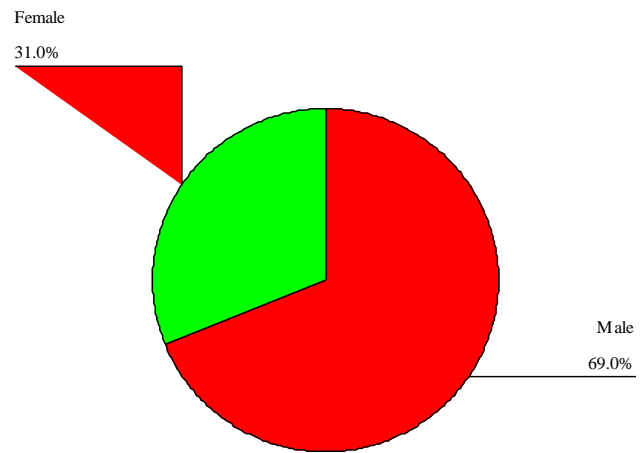

Figure 11: Respondents distribution based on gender

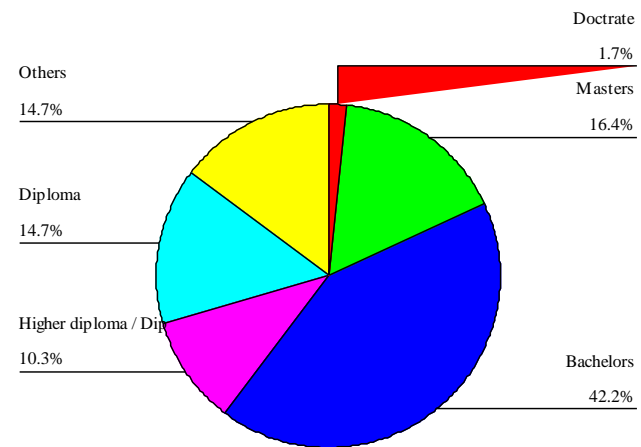

Figure 12: Respondents distribution based on the highest academic qualification

According to data presented in Fig. 12, only 1.7% of the respondents had a Doctorate degree, while 16.4% had Masters Degree. Forty two point two percent had Bachelors degree, 10.3% having a higher Diploma, 14.7% held a Diploma and 14.7% of the respondents had other academic qualifications. There are fairly low numbers of personnel in general trained at Masters and Doctorate level yet this are the cadres that lead in research undertakings.

When it came to relevant qualification in terms of ICT, their distribution of the highest technical qualification is presented in Figure 13.

From Figure 13, it is clear that only 13.8% of the respondents had Masters Degree in ICT related fields, 22.4% had Bachelors degree, 6.9% had higher Diploma, 6% had Diploma while the rest held other qualifications. An interview with a few of those who had other ICT related qualifications revealed that most respondents were holders of computer literacy skills (Basics / packages) certificates. The fact that there was hardly anyone with a doctorate and only 13.8% of masters degree holders suggests that there are few skilled qualified personnel in the ICT area. The lack is likely to have an impact on consultancy and research undertakings from within the country and developing nations on how best to

apply green ICT in the local environment. The limited consultancy service in the area may likely also limit the awareness levels about the technology.

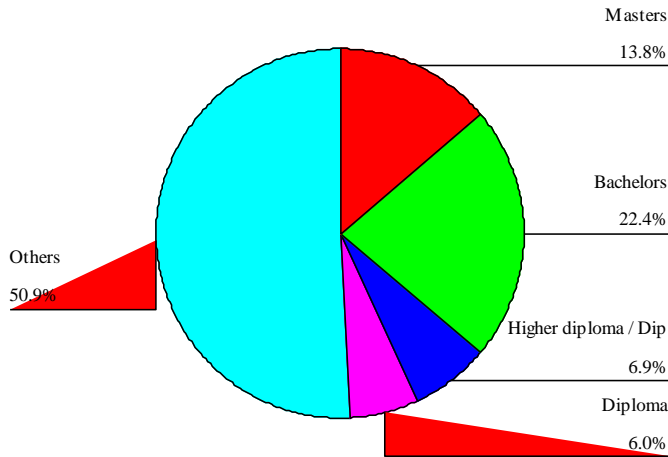

Figure 13: Respondents distribution based on technical ICT qualification

2) Spearman's rho coefficients of relationships between demographics and dimensions of G-readiness model

The first to be analysed was that of demographics with the aspects of pervasiveness. The findings are presented in table 1.

From the evaluations obtained in table 1, it can be observed that the age of respondents which may be considered

to be directly related to ones experience has a significant relationship with the understanding of green ICT relevance awareness factors to an organisation's business. Based on spearman's rho coefficient values to the age of respondents, there is a moderate direct relationship at 0.01 (1-tailed) significance level with the understanding on reducing of costs of powering ICT infrastructure (0.284), purchasing more environmentally friendly ICT technology (0.281), use of ICT to minimise carbon emitting business practices (0.349) and improving energy efficiency of data centres (0.224). At the same time it has a weak indirect relationship with discarding ICT items in an environmentally friendly manner of coefficient 0.180 at a significant level of 0.05 (1-tailed). It is also apparent from the evaluations obtained in table 1 that there is no significant relationship with regard to gender and the green ICT awareness variables. Therefore the gender of the respondents has no influence on the awareness level of a given person and hence the organisations.

The highest general academic qualification seems to have a significant relationship with the green ICT awareness. From the spearman's rho coefficient values obtained the highest general academic qualification of respondents has a moderate indirect relationship at 0.01 (1-tailed) significance level with the use of ICT to minimise carbon emitting business practices (0.225), improving energy efficiency of data centres (0.256), and reducing the costs of running data centres (0.330). At the same time it has a direct weak relationship with reducing ICT's contribution to green house gas emissions (0.192) and complying with green regulatory requirements (0.173).

TABLE 1: SPEARMAN'S RHO CORRELATION COEFFICIENTS OF AWARENESS PERVASIVENESS AND ICT PERSONNEL VARIABLES

		Reducing the costs of powering ICT infrastructure	Purchasing more environmentally friendly ICT technology	Use of ICT to minimise carbon emitting business practices	Discarding ICT items in an environmentally friendly manner	Improving energy efficiency of data centres	Reducing the costs of running data centres	Reducing ICT's contribution to green house gas emissions	complying with green regulatory requirements
Age of respondent	Correlation Coefficient	.284 (**)	.281 (**)	.349 (**)	-.180 (*)	.224 (**)	.152	-.039	.098
	Sig. (1-tailed)	.001	.001	.000	.026	.008	.052	.338	.152
Respondent's gender	Correlation Coefficient	-.102	.002	.017	.056	-.152	-.027	.104	-.043
	Sig. (1-tailed)	.138	.490	.430	.275	.051	.385	.133	.326
Highest acad. qualifications	Correlation Coefficient	.025	.070	-.225 (**)	-.137	-.256 (**)	-.330 (**)	.192 (*)	.173 (*)
	Sig. (1-tailed)	.395	.226	.007	.072	.003	.000	.019	.035
Highest ICT qualification	Correlation Coefficient	.236 (**)	.159 (*)	.117	-.132	-.043	-.114	.163 (*)	.244 (**)
	Sig. (1-tailed)	.005	.044	.106	.079	.323	.111	.040	.005

\* Correlation is significant at the 0.05 level (1-tailed).  
\*\* Correlation is significant at the 0.01 level (1-tailed).

Lastly, there is a significant relationship between the highest ICT qualification and green ICT awareness factors. According to spearman's rho coefficient values obtained the highest technical academic qualification of respondents has a indirect relationship at 0.01 (1-tailed) significance level with reducing the costs of powering ICT infrastructure that is moderate (0.236), purchasing more environmentally friendly ICT technology that is weak (0.159), reducing ICT's

contribution to green house gas emissions that is weak (0.163) and complying with green regulatory requirements that is moderate at 0.244.

In order to establish how the ICT personnel related variables were related with the green ICT drivers, spearman's rho coefficients were evaluated and the results are presented in table 2.

TABLE 2: SPEARMAN'S COEFFICIENT CORRELATION BETWEEN THE ICT PERSONNEL VARIABLES AND GREEN ICT DRIVERS

		Age of respondent	Respondent's gender	Highest academic qualifications	Highest ICT qualification
E-waste management	Coefficient	.146	-.157 (*)	-.375 (**)	-.123
	Sig. (1-tailed)	.061	.049	.000	.098
Efficiency of cooling and lighting data centre	Coefficient	.179 (*)	-.091	.129	.232 (**)
	Sig. (1-tailed)	.030	.170	.089	.007
Overall environmental footprint	Coefficient	.301 (**)	-.076	-.204 (*)	-.027
	Sig. (1-tailed)	.001	.210	.015	.390
ICT's contribution to green house gas emissions	Coefficient	.207 (*)	.100	-.048	.187 (*)
	Sig. (1-tailed)	.014	.146	.307	.023
ICT suppliers' environmental footprint	Coefficient	.118	-.040	.324 (**)	.276 (**)
	Sig. (1-tailed)	.110	.337	.000	.002
Regulations in green house gas emissions	Coefficient	.265 (**)	.216 (**)	.181 (*)	.400 (**)
	Sig. (1-tailed)	.002	.010	.026	.000

\* Correlation is significant at the 0.05 level (1-tailed).  
\*\* Correlation is significant at the 0.01 level (1-tailed).

From the evaluations obtained in table 2, it can be observed that the age of respondents has a significant relationship with the green ICT drivers of an organisation's business. Based on spearman's rho coefficient values to the age of respondents, there is a weak direct relationship at 0.05 (1-tailed) significance level with efficiency of cooling and lighting data centre at 0.179, a moderate direct relationship at 0.01 (1-tailed) significance level with overall environmental footprint at 0.301 of 0.207, and a moderate direct relationship of 0.265 at 0.05 (1-tailed) significance level with ICT's contribution to green house gas emissions.

It is also apparent from the evaluations obtained in table 2 that there are only two items of the eight where there is a significant relationship with regard to gender and the green ICT drivers. The only direct significant relationship between gender and green ICT drivers is has moderate relationship found on the regulations in green house gas emissions with spearman's rho coefficient of 0.216 at 0.01, (1-tailed) significance. The other which is an indirect significant relationship between gender and green ICT drivers is a weak relationship found with e-waste management that has a spearman's rho coefficient of -0.157 at 0.05, (1-tailed) significance. Therefore the gender of the respondents has no

major influence on green ICT drivers likely to influence a given person and hence the organisations to implement green ICT. The general highest academic qualifications seem to have a significant relationship with ICT drivers. According to the results in table 1 it can be observed that there exists an indirect moderate relationship with E-waste management (-0.375) and overall environmental footprint (-0.204). There is a direct relationship also with ICT suppliers' environmental footprint that is moderate (0.324) and a weak relationship with regulations in green house gas emissions (0.181).

The technical qualifications seem to have a significant relationship with green ICT drivers. With exception of ICT's contribution to green house gas emissions where the relationship is a direct weak one at 0.187, (1-tailed), significance level of 0.05, the rest have a moderate direct relationship with a 0.01 significance level. Efficiency of cooling and lighting data centre has spearman's rho value of 0.232, ICT suppliers' environmental footprint has spearman's rho value of 0.276 and regulations in green house gas emissions has spearman's rho value of 0.400. The findings of significant relationships between the demographics and the policy and practice maturity dimensions are presented in table 3.

TABLE 3: SPEARMAN'S RHO COEFFICIENT CORRELATIONS BETWEEN ICT PERSONNEL VARIABLES AND GREEN ICT POLICY AND PRACTICE MATURITY VARIABLES

		Age of respondent	Respondent's gender	Highest academic qualifications	Highest ICT qualification
<b>Policy maturity</b>					
Green ICT	Correlation Coefficient	.148	.048	.319 (**)	.341 (**)
	Sig. (2-tailed)	.117	.615	.001	.000
Environmentally friendly purchasing	Correlation Coefficient	-.060	.207(*)	.135	.101
	Sig. (2-tailed)	.533	.029	.158	.290
Corporate social responsibility	Correlation Coefficient	-.039	.067	.269 (**)	.168
	Sig. (2-tailed)	.678	.475	.004	.072
<b>ICT practice maturity</b>					
<b>ICT sourcing</b>					
Prefers ICT suppliers that have a green track record	Correlation Coefficient	-.008	.191(*)	-.132	-.098
	Sig. (2-tailed)	.929	.042	.162	.301
Is shortening ICT equipment refresh periods to gain access to more efficient energy equipment	Correlation Coefficient	.095	.066	.181	.195(*)
	Sig. (2-tailed)	.310	.483	.052	.036
<b>ICT operations practice</b>					
Enforce personal computer power management	Correlation Coefficient	.093	-.015	.103	.201(*)
	Sig. (2-tailed)	.329	.875	.278	.033
Implements ICT projects to monitor the organisation's carbon footprint	Correlation Coefficient	.195(*)	-.082	-.148	-.045
	Sig. (2-tailed)	.036	.383	.112	.634
<b>End life management</b>					
Disposes of ICT equipment in environmentally friendly manner	Correlation Coefficient	.040	.006	-.068	-.315 (**)
	Sig. (2-tailed)	.670	.947	.471	.001

\* Correlation is significant at the 0.05 level (2-tailed).

\*\* Correlation is significant at the 0.01 level (2-tailed).

From table 3, implementation of ICT projects to monitor the organisation's carbon footprint had a significant weak positive (0.195) relationship with the age of the respondents at a 2-tailed significance level of 0.05. The respondents gender had a significant moderate positive relationship of 0.207 on environmentally friendly purchasing and 0.191 on prefers ICT suppliers that have a green track record at a 2-tailed significance level of 0.05.

For the highest academic qualification there was a significant moderate positive relationship of 0.319 and 0.269 with green ICT and corporate social responsibility

respectively at 0.01 in 2-tailed significance level. Finally with regard to the highest ICT training had a positive moderate relationship of 0.341 at 0.01 in 2-tailed significance level, shortening ICT equipment refresh periods to gain access to more efficient energy equipment had a positive weak relationship of 0.195 at 0.05 in 2-tailed significance level, enforcement of personal computer power management had a had a positive weak relationship of 0.201 at 0.05 in 2-tailed significance level and finally the disposal of ICT equipment in environmentally friendly manner had a had a negative moderate relationship of 0.315 at 0.001 in 2-tailed significance level.

TABLE 4: SPEARMAN’S RHO COEFFICIENT CORRELATIONS BETWEEN ICT PERSONNEL VARIABLES AND GREEN ICT TECHNOLOGY AND GOVERNANCE MATURITY VARIABLES

		Age of respondent	Respondent's gender	Highest academic qualifications	Highest ICT qualification
<b>Technology</b>					
<b>ICT infrastructure</b>					
Rightsizing ICT equipment	Correlation Coefficient	-.005	-.095	-.032	.214(*)
	Sig. (2-tailed)	.962	.320	.741	.023
Storage teiring	Correlation Coefficient	.081	-.060	.142	.260 (**)
	Sig. (2-tailed)	.387	.526	.130	.005
Storage virtualisation	Correlation Coefficient	.152	.118	.039	.185(*)
	Sig. (2-tailed)	.104	.207	.677	.047
Print optimization	Correlation Coefficient	-.107	.117	.263 (**)	-.047
	Sig. (2-tailed)	.258	.215	.005	.623
Power down systems	Correlation Coefficient	.123	-.169	-.215 (*)	-.059
	Sig. (2-tailed)	.190	.070	.021	.529
<b>Network infrastructure technologies</b>					
DC powered ICT equipment	Coefficient	.033	.043	.268 (**)	.248 (**)
	Sig. (2-tailed)	.732	.650	.005	.009
High efficiency standby power system	Coefficient	.188(*)	-.062	.129	.234(*)
	Sig. (2-tailed)	.048	.516	.174	.013
Install energy efficient lights	Coefficient	.108	.045	.148	.203(*)
	Sig. (2-tailed)	.251	.634	.115	.030
<b>ICT governance</b>					
CEO plays a leading role in green ICT initiatives	Correlation Coefficient	.117	.082	.078	.299 (**)
	Sig. (2-tailed)	.217	.387	.409	.001
Targets are set to reduce the organisations carbon footprint	Correlation Coefficient	-.143	.040	.235(*)	.107
	Sig. (2-tailed)	.134	.673	.013	.261

\* Correlation is significant at the 0.05 level (2-tailed).

\*\* Correlation is significant at the 0.01 level (2-tailed).

From table 4, it can be observed that the respondent’s age had only one significant weak positive relationship of 0.188 at a 2-tailed 0.05 significance level with the high efficiency standby power system. Respondents’ gender had no significant relationship with any of the elements of the green ICT technology and ICT governance. The highest academic qualification had a positive moderate relationship of 0.0.263 at 0.01 in 2-tailed significance level, a negative weak relationship of 0.215 at 0.05 in 2-tailed significance level with print optimization, a had a positive moderate relationship of

0.268 at 0.01 in 2-tailed significance level with DC powered ICT equipment and had a positive weak relationship of 0.235 at 0.05 in 2-tailed significance level with targets being set to reduce the organisations carbon footprint. Finally the highest ICT technical qualification had a positive weak relationship of 0.214 at 0.05 in 2-tailed significance level with rightsizing ICT equipment, had a positive moderate relationship of 0.260 at 0.01 in 2-tailed significance level with storage teiring, had a positive weak relationship of 0.185 at 0.05 in 2-tailed significance level with storage virtualisation, had a positive

moderate relationship of 0.248 at 0.01 in 2-tailed significance level with DC powered equipment, had a positive weak relationship of 0.234 at 0.05 in 2-tailed significance level with high efficiency standby power system, had a positive weak relationship of 0.203 at 0.05 in 2-tailed significance level with installation of energy efficient lights, and had a positive moderate relationship of 0.299 at 0.01 in 2-tailed significance level with the CEO playing a leading role in green ICT initiatives.

V. G-READINESS MODEL EXTENSION

From the analysis of relationships presented in IV B, it was found that the existed significant weak or moderate relationships at significance level of 0.01 or 0.05 between the Green ICT, environmentally friendly purchasing, corporate social responsibility, prefers ICT suppliers that have a green track record, shortening ICT equipment refresh periods to gain access to more efficient energy equipment, ICT operations practice, enforce personal computer power management, implements ICT projects to monitor the organisation's carbon

footprint, end life management, and disposes of ICT equipment in environmentally friendly manner elements within the dimensions of ICT policy and practice. There was also significant weak or moderate relationship at significance level of 0.01 or 0.05 between rightsizing ICT equipment, storage teiring, storage virtualisation, print optimization, power down systems, DC powered ICT equipment, high efficiency standby power system, install energy efficient lights, CEO plays a leading role in green ICT initiatives and targets are set to reduce the organisations carbon footprint of the technology and ICT governance dimensions.

Based on the fact that the G-readiness levels of developing economies being lower than those of the middle and developed economies when measured on the Molla's G-readiness model and the many element's relationship between ICT personnel variables with the G-readiness dimensions, an extension of the model was made as provided for in Figure 14.

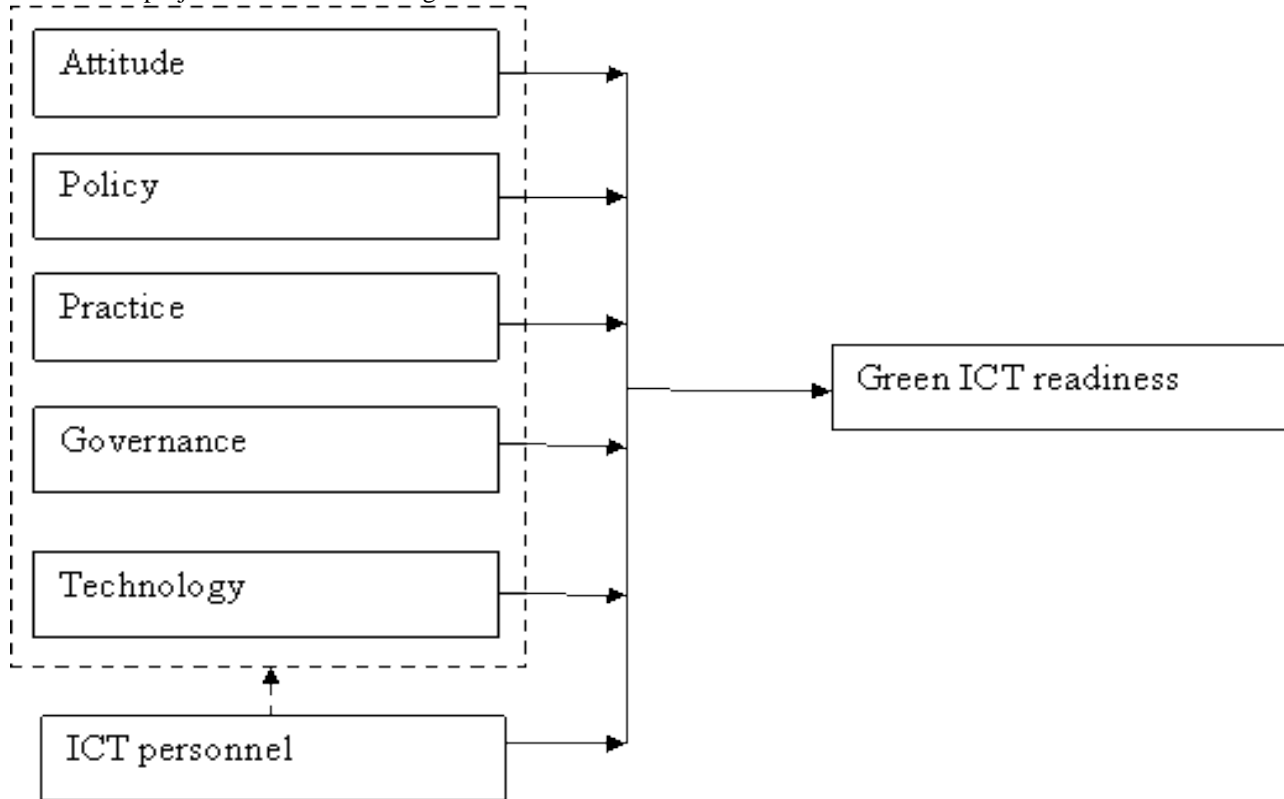

Figure 14: Extended Molla's green ICT readiness model for organisations in developing economies

In the extended version herein given, the study proposes that ICT personnel preparedness contributes directly to how an organisation gets ready in terms of green ICT readiness and yet has influence on the level at which the other five dimensions get to be ready as witnessed by the moderate significant relationships discussed in section 5.2.2. For this study the first four aspects within the ICT personnel to be considered were gender, experience (age), academic training and technical ICT (green ICT) training.

VI. CONCLUSION AND RECOMMENDATION

The study established that the level of green ICT readiness is lower in developing economies. It also established that there was a significant relationship between ICT personnel variables and green ICT preparedness dimensions. Based on the established significant relationships, it proposed an extended G-readiness model from the initial Molla's model for establishing the level of green ICT readiness for an organisation.

The study recommends further studies to be conducted to establish the full range of ICT personnel characteristics on green ICT readiness.

#### ACKNOWLEDGMENT

We would like to acknowledge the input by the Kibabii University College community and Prof. Leonard Wamocho during the research.

#### REFERENCES

- [1] Molla A. & Cooper V. (2009). Green IT readiness: A framework and preliminary proof of concept. *Australasian journal of information systems*, 16(2): 5-23.
- [2] Cooper V. A. & Molla A. (2012). Developing green IT capability: An absorptive capacity perspective. *Pacific asia Conference on Information Systems* (p. T5\_148doc). [www.pacis2012.org/files/papers/pacis2012\\_T5\\_cooper\\_148.doc](http://www.pacis2012.org/files/papers/pacis2012_T5_cooper_148.doc).
- [3] Wabwoba F., Wanyembi W. D. & Omuterema S. (2012). Barriers to green ICT implementation in Kenya. *International Journal of Science and Technology*, 2(12): 823-836
- [4] Molla A., Cooper V. A., & Pittayachawan S. (2009). IT and eco-sustainability: Developing and validating a green IT readiness model. *Thirtieth International Conference on Information Systems*, (p. 17).
- [5] Philipson G. (2010). *A Green ICT Framework: Understanding and Measuring Green ICT*. Australia: 2010 Connection Research Services Pty Ltd (ABN 47 092 657 513).
- [6] Cooper V. & Molla A. (2010). *Conceptualizing Green IT Organizational Learning (GITOL)*. *Green IT Working Paper Series. Paper No. 3/2010*. Melbourne: School of Business Information Technology and Logistics, RMIT University.
- [7] Boughton, C. (2009). What is an ICT professional anyway. *Australasian journal of information systems*, 16(1):149-163.
- [8] Rao P. & Holt D. (2005). Do green supply chains lead to competitiveness and economic performance? *International Journal of Operations & Production Management*, 25 (9): 898-916.
- [9] Tenhunen, M. (2011). *Conceptualizing and Measuring Green IT Readiness in Finnish Companies. Application Area: Electronic Invoice*. Aalto University (Master's Thesis).
- [10] [10] Velte T. J., Velte A. T. & Elsenpeter R. (2008). *Green IT: reduce your information system's environmental impact while adding to the bottom line*. New York: McGraw Hill.
- [11] Alsever, J. (2008). *The 'green' way to dump electronic junk*. Retrieved February 12, 2012, from [www.mnscb.com/id/24163506/](http://www.mnscb.com/id/24163506/)
- [12] Chen A., Boudreau M., & Watson R. (2008). Information systems and ecological sustainability. *Journal of systems and information Technology, Sustainability and Information Systems*, 24 (3): 186-201.
- [13] Elliot S., & Binney D. (2008). Environmentally Sustainable ICT: Developing corporate capabilities and an industry relevant IS research agenda. *Proceedings of PACIS, 4-7 July Suzhou, China*.
- [14] Uddin M. and Rahman A. A. (2011). Virtualization implementation model for cost effective and efficient data centers. *International Journal of Advanced Computer Science and Applications*, 2 (1): 69-74.
- [15] Mueen U. & Azizah A. R. (2012). Server consolidation: An approach to make data centers energy efficient and green. *International journal of science and engineering research*, 1(1): 1-7.
- [16] [16] Weill P. & Ross J. W. (2004). *IT governance: how top performers manage IT decision rights for superior results*. Harvard Business Press.
- [17] Schmidt N. & Kolbe L. M. (2011). Towards a contingency model for green IT Governance. *AMCIS 2011 Proceedings*.
- [18] Jenkin T. A., Webster J. & McShane L. (2010). An agenda for "Green" information technology and systems research. *Information and organisation*.
- [19] Schmidt N., Ere K., Kolbe L. M. & Zarnekow R. (2010). Predictors of green IT adoption: Implications from an Empirical Investigation. *AMCIS 2010 Proceedings*. available at: <http://aisel.aisnet.org/amcis2010/367>.
- [20] Ogunyemi A. A. & Johnston A. K. (2012). Towards an organisational readiness framework for emerging readiness for technologies: An investigation of antecedents for South African organisations' readiness for server virtualisation. *The electronic Journal on information systems in developing countries*, 53(5):1-30.

- [21] Maranto-Vargas D. and Rangel R. G. T. (2007). Development of internal resources and capabilities as sources of differentiation of SME under increased global competition: A field study in Mexico. *Technical forecasting and social change*, 70:90-99.
- [22] [22] Mariani M. & Imam K. (2012). A Preliminary Study of Green IT Readiness in Indonesian Organizations. *Journal of Energy Technologies and Policy*, 2 (5): 1-10.
- [23] [23] Olofsson A & Ohson S. (2006). General belief and environmental concerns: Transatlantic comparisons. *Environment and Behaviour*, 38: 768-790.

#### AUTHORS PROFILE



**Mr. Franklin Wabwoba** is a lecturer at Kibabii University College (Kenya) in the Department of Information Technology. He holds a Master of Science (Computer Applications) degree from Kenyatta University; Endorsement (Educational Management) from University of South Africa and Bachelor of Education (science: Mathematics and Computer Science) degree from Egerton University and is a PhD (Information Technology) candidate at Masinde Muliro University of Science and Technology. He has taught Computer Science and Information Technology courses for many years. He has ICT industrial experience having worked with Mumias Sugar Company. He has presented several papers in scientific conferences and has a number of publications in referred journals. He has a strong research interest in green ICT, the impact of ICT applications on the community and integration of ICT into education. He is a professional member of the Association for Computing Machinery (ACM).



**Dr. Gregory Wabuke Wanyembi (PhD)** obtained his doctorate in management of ICTs from Delft University of Technology, The Netherlands, in 2002. He has published widely in the area of management and strategic utilization of ICTs in developing countries. He is engaged in several research projects and supervises a number of postgraduate students at both masters and PhD drawn from universities in Kenya. He is also a reviewer of journal articles, and an external examiner at two universities. He is a former senior lecturer and chairman at the Department of Computer Science, Masinde Muliro University of Science and Technology, Kenya.



**Dr. Stanley Omuterema Oluchiri (PhD)** is a lecturer in the Department of Disaster Management and Sustainable Development at Masinde Muliro University of Science and Technology. He held the position of centre coordinator of the Nairobi campus of Masinde Muliro University of Science and Technology for a number of years. He obtained his doctorate Moi University. He has published widely. He has wide experience having taught in secondary school, Eldoret Polytechnic, and Masinde Muliro University of Science and technology.



**Mr. Kelvin Kabeti Omieno** is an Assistant Lecturer in the Department of Computer Science, Masinde Muliro University of Science and Technology, Kenya. He holds MSc in IT and First Class Honors Degree in Computer Science from Masinde Muliro University of Science and Technology (Kenya). He is currently pursuing PhD in Information Technology of Strathmore University (Kenya). He has been involved in a number of research projects of ICTs and development, including computational grid project, and E-waste management in Kenya. Mr. Omieno has published widely in journals and conference proceedings in Information technology and ICTs for development. He is a professional member of the Association for Computing Machinery (ACM).